

Calculation and analytical methods for building components

Deliverable report 1.4



Deliverable Report: Final version. Issue date on 30 November 2016

INSITER - Intuitive Self-Inspection Techniques using Augmented Reality for construction, refurbishment and maintenance of energy-efficient buildings made of prefabricated components.

This research project has received funding from the European Union's H2020 Framework Programme for research and innovation under Grant Agreement no 636063.

Calculation and analytical methods for building components

Deliverable report 1.4

Issue Date	30 November 2016	
Produced by	DEMO Consultants	
Main authors	Sanja Durmisevic	(DMO)
	Benedetta Marradi	(AICE)
Co-authors	Klaus Luig, Dieter Jansen	(3L)
	Ruud Geerligs, Perica Savanovic	(SBRCURnet)
	Antonfranco Pasquale	(AICE)
	Emanuele Piaia, Luigi Vessella	(IAA)
Version:	Final	
Reviewed by	Carlos Barcena	(DRAGADOS)
	Jan-Derrick Braun	(HVC)
Approved by	Rizal Sebastian – Technical Coordinator	(DMO)
	Ton Damen – Project Coordinator	(DMO)
Dissemination	Public	

Colophon

Copyright © 2016 by INSITER consortium

Use of any knowledge, information or data contained in this document shall be at the user's sole risk. Neither the INSITER Consortium nor any of its members, their officers, employees or agents accept shall be liable or responsible, in negligence or otherwise, for any loss, damage or expense whatever sustained by any person as a result of the use, in any manner or form, of any knowledge, information or data contained in this document, or due to any inaccuracy, omission or error therein contained. If you notice information in this publication that you believe should be corrected or updated, please contact us. We shall try to remedy the problem.

The authors intended not to use any copyrighted material for the publication or, if not possible, to indicate the copyright of the respective object. The copyright for any material created by the authors is reserved. Any duplication or use of objects such as diagrams, sounds or texts in other electronic or printed publications is not permitted without the author's agreement.

This research project has received funding from the European Union's H2020 Framework Programme for research and innovation under Grant agreement no 636063.

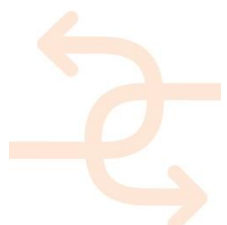

Publishable executive summary

Background / rationale of the research

Designing by having an end performance in mind, is a great challenge for Architecture, Engineering and Construction industry (AEC). During the construction phase, the criteria established during the Design Phases should be met and building performance, such as Energy efficient Building, as outlined in the Construction Documents is validated through observations and testing (NIBS, 2012).

The reason why the construction phase is critical for building performance is because of the sequence of the building process itself. Once foundation is realised and walls are placed, it is not possible to make improvements on the foundation any more. This is valid for every next step done during construction phase. During construction phase, there is no iteration planned to control for possible errors hence it is very difficult to improve errors at the later stage. This requires good quality check during construction phase and good communication flow between parties involved at different stages of construction process.

The main goals of the research presented in this report are:

- To define the critical building components with highest impacts on the quality and performance of energy-efficient buildings.
- To develop systematic procedures for self-instruction and self-inspection of building components based on analytical and quantifiable methods by using adequate measurement instruments.
- To analyse the Key Performance Indicators (KPIs) measured in relation with building components in order to detect and prevent errors timely.

There are several research questions that have been addressed in this deliverable:

- What are most critical building components and their critical impacts on energy performance?
- What are the required preconditions necessary for reducing errors during construction process?
- What are the most common construction errors occurring during construction process related to critical building components?
- What are the most important KPIs measurement parameters that affect the energy performance?
- How the INSITER methodology can help reduce the amount of errors during construction phase?

Main results and conclusions

The most important result of the research presented in this report is: the description of analytical and quantifiable method for self-instruction and self-inspection of building envelopes (façade and roof) and ground floor and foundation. The main focus lies on the critical joints between different building components where errors and flaws during construction process usually take place, and these will cause a certain loss of performance of the whole building.

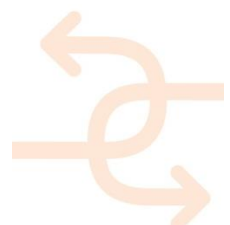

Having analysed joints of different building components, the relevant KPIs measurement aspects and their relation to the most frequently made errors during the construction process, it became obvious that geometric accuracy and the ways that the joints and connecting elements are treated is the most crucial measurement aspect that affects all KPIs that are relevant for energy performance of the buildings.

The tolerance boundaries that indicate to which extent an imperfection resulting from the production process compromises energy performance are also discussed. The deliverable subsequently determine which parameters need to be measured and therewith serve as the input for development of hardware tools, software tools and Building Information Modelling/Augmented reality.

This report also presents practical methods to ensure an efficient communication flow between the parties involved at different stages of construction process. The deliverable proposes, based on stakeholder analysis and by means of self-inspection, a clarification of responsibilities between the involved stakeholders / construction actors for detecting and preventing error during the construction process and at which stage.

More specific outcomes of the research presented in this deliverable are listed below:

Addressing **two main EU directives and related objectives**:

- 1) Energy Performance of Buildings Directive, EPBD and
- 2) Energy Efficiency Directive, EED (Chapter 2);

Definition of **Critical Building Components** of Energy Efficient Buildings for further analysis in relation to the most frequent construction errors (Chapter 2);

Defines **basic assumptions** as a precondition for applying INSITER methodology and **introduction of 'joint' approach** for further development of the methodology for self-inspection (Chapter 2);

Defines **Practical steps for self-inspection** to measure the relevant parameters, including use of relevant measurement devices addressing the real problems on-site (Chapter 3 and 4);

Selection of the main **EU technical norms** related to KPIs and parameters and implementing DIN 18202 for Geometric Conformity of Elements and/or NEN 3682 for laser scanning. This task is very important for the definition of the main EU standard used to evaluate the quality assurance during the assembly/construction phase (Chapter 3);

Development of a **method to calculate KPIs** based on measured parameters (Chapter 3)

Defines the **stages** where KPIs measurement parameters are relevant (Chapter 3, 4, 5, 6, and 7)

Relevant stakeholders have been identified having studied the most common errors related to assembly in order to determine the most effective communication and coordination procedure, and to clarify responsibilities and liabilities (Chapters 3, 4, 5,6, and 7)

Defining **problem owners** and **communication flow** in relation to relevant KPIs measurement aspects during construction process (Chapters 3, 4, 5, 6 and 7)

Defining **prevention measures** in relation to relevant KPIs and measurement aspects during construction process (Chapters 3, 4, 5, 6, and 7)

Defining **practical steps for self-inspection** to measure the relevant parameters, including use of relevant measurement devices (Chapters 3, 4, 5, 6 and 7)

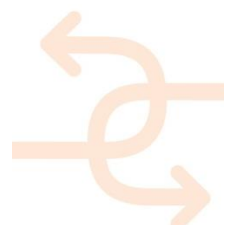

Further discussions and recommendations for follow-up research

In the follow-up research, detailed methods for evaluation and decision-making will be developed regarding the errors, focusing on the joint between two building components and establishing whether an observed error is really an error and therefore requires rework. The method will also regard the thresholds both at component or system level as well as whole building level considering the relevant quality and performance requirements.

Next to this, the implementation guidelines will be developed for new construction projects and for refurbishment projects.

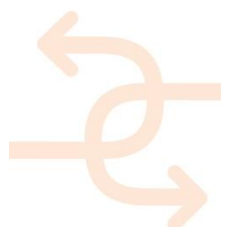

List of acronyms and abbreviations

- AEC: Architecture, Engineering and Construction industry
- AR: Augmented Reality
- BIM: Building Information Modelling
- DoA: Description of the Action
- EE: Energy Efficiency
- EeB: Energy Efficient Buildings
- HFM: Heat Flow Method
- HVAC: Heating, Ventilation, Air Conditioning
- ISO: International Organisation for Standardization
- KPI: Key Performance Indicator
- QR code: Quick Response Code
- MEP: Mechanical, Electrical, Plumbing
- MTT: Methods, Tools and Techniques
- NDT: Non-destructive test

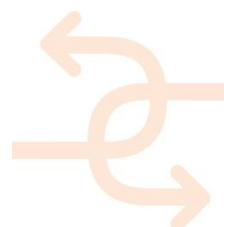

Definitions

Construction Phase: The process of constructing the building to meet the criteria established during the Design Phases and where the building performance as outlined in the Construction Documents is validated through observations and testing (Source: NIBS Guideline 3-2012 Building Enclosure Commissioning Process BECx This Guideline is for Use with ASHRAE Guideline 0-2005: The Commissioning Process, 2012)

Guideline: A document written in informative language that provides state-of-the-art design or best practice guidance. Guidelines provide information on system selection, design approaches, practices and goals as well as setting desirable and achievable performance levels. Guidelines may address issues of concern such as start-up and commissioning, operation and maintenance and assurance that the goals of the associated standard (if any) are achieved (Source: ASHRAE 2010 Project Committee Manual of Practice (PC MOP))

Joints: Geometrical requirements which depend on both constructive system and may vary considering different issues (e.g. thermal variations, structural joints due seismic requirements)

Connections: Concern the interface either between elements of the same type (e.g. modules) or between different building components (e.g. roof / façade, ground floor / façade)

Nominal size is the planned, theoretical size

Actual size is the built size that can be measured

Actual deviation is the difference between nominal and actual size

Minimum size is minimum acceptable size

Maximum size is maximum acceptable size

Tolerance is difference between minimal size and maximum size

Limiting deviation is the limiting deviation of a size is defined as the difference between the maximum size and the nominal size and between the minimum size and the nominal size. The limiting deviation of an angle is defined as the difference between the maximum angle and the nominal angle and between the minimal angle and the nominal angle (as a value in mm)

Angular misalignment is a difference between nominal angle and actual angle (as a value in mm) Concerning angular misalignment from the nominal value the deviation is defined as the distance (in mm) from a point to a reference line (see figures below)

Flatness deviation is a deviation of an actual surface from the nominal plain (as a value in mm that refers to the distance between two measuring points). Concerning flatness deviation from the nominal value the deviation is defined as the distance (in mm) from a point to a reference line (see figures below)

Alignment is a connecting line between two points

Misalignment is an actual distance (in mm) of a point from the alignment that refers to the distance between two metering points

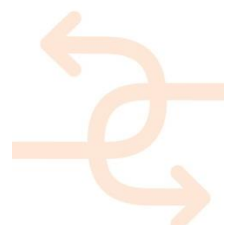

Fulfilment of the Description of Action (DoA) in D1.4

Accessibility of this deliverable

This deliverable is presented in 1 part: Report / documentation (this document). For INSITER consortium and European Commission representatives, the deliverable is available both in the EC Participant Portal (INSITER project) as well as in the SharePoint project website.

After approval by the European Commission, the public version of this deliverable will be published on the INSITER public website, and disseminated through the common dissemination channels.

Fulfilment of WP, Task and Deliverable scope and objectives

Summarised objectives as stated in DoA	Results presented in this deliverable
<p>WP 1 scope and objectives:</p> <p>Key performance indicators (KPIs) and parameters addressing quality and energy performance</p> <p>Techniques for self-inspection and self-instruction in different types of projects (new construction, refurbishment, commissioning, and maintenance).</p>	<p>Addressed:</p> <p>Selection and analysis of KPIs and parameters relevant to the critical building components have been made.</p> <p>Relevant KPIs measurement parameters are addressed through analysis of critical building components, including in depth analysis of tools and methods which are relevant for self-inspection (see Chapters 3, 4, 5, 6 and 7)</p> <p>Conceptual techniques to perform self- inspection on these critical building elements are explained</p>

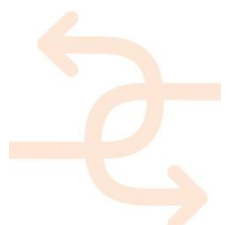

<p>Task 1.2 scope and objectives:</p> <p>Self-inspection techniques using 3D laser measurement systems, infrared non-destructive testing.</p> <p>Multidisciplinary approach, including research on quantitative analysis, involving techniques from building physics, civil engineering and material engineering disciplines.</p> <p>Integration of BIM in design, manufacturing and assembly process of building components.</p> <p>Review of the software tools for building condition assessment including lifecycle cost validation.</p> <p>User and process requirements for upgrading the hardware equipment, software tools and BIM capabilities for self-inspection and self-instruction.</p> <p>Development of a defect inspection manual involving consultations group with all actors in the construction industry.</p> <p>Analysis based on national, EU and international norms/standards for technical inspection</p>	<p>Addressed:</p> <p>The problem identification is a part of INSITER's technical solution in order to identify and prevent errors related with critical building components. 3D laser measurement systems is addressed in section 4.7; 5.4 and 6.3; and infrared technique (section 5.4; section 7.3; and section 7.4)</p> <p>Addressing KPIs (both measurement and calculation) in several multidisciplinary workshops as a part on decision-making process</p> <p>Analysis of the added values of BIM for self-instruction and self-inspection of critical building components (Chapter 2).</p> <p>Defect inspection manual addressed. Implementing directive for timber frame elements addressed in Appendix 5.</p> <p>References made to inspection norms relevant to critical building elements.</p>
<p>Deliverable D1.4 scope and objectives:</p> <p>Calculation and analytical methods for building components focusing on self-inspection of critical building components that affect quality and energy-performance.</p>	<p>Achievement percentage: 100%</p> <p>Specific results fulfilling the deliverable objectives:</p> <p>Selection of KPIs measurement aspects applied to the critical building components</p> <p>Detailed technical description of prefab components affecting EeB performance</p> <p>Development of a 3D allocation model of characteristic construction errors (joint approach)</p> <p>Developed method to take measurements to obtain values of the parameters relevant for selected KPIs</p> <p>Method to calculate the measured values of the KPIs with various examples</p>

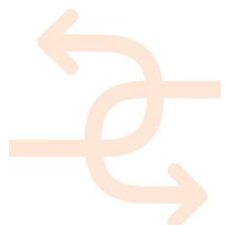

<p>Project's progress relevant to the deliverable within the corresponding timeframe (Year 1-2):</p> <ul style="list-style-type: none"> • Clear identification of existing bottlenecks, most frequent errors, and shortcomings in skills in the construction processes across the EU. Such identification is based on reliable and up-to-date investigations (e.g. Dutch "Bouw Transparant", UK "Constructing Excellence", and similar reports from Germany, Spain and Italy). • Critical review of process, performance, and inspection norms (e.g. Dutch norm NEN 2767 on condition assessment, Energy Performance Coefficient norms) • Definition of plausible KPIs. KPIs are integrated in the self-inspection protocols/manuals. • Calculation methods for performance assessment as well as self-instruction. • Further developing self-inspection techniques coherent with an efficient construction process workflow. Stakeholder analysis becomes of a key importance to determine the most effective communication and coordination methods, and to clarify responsibilities and liabilities, Professional Indemnity Insurance, as well as organizational and legal constraints. 	<p>Addressed 100%:</p> <ul style="list-style-type: none"> • The most frequent construction errors of prefab buildings and existing shortcomings or bottlenecks are further analysed and translated into self-inspection recommendations for critical building elements. • The main EU inspection norms and performance standards have been collected and presented in the previous deliverable D1.1, and within this deliverable this knowledge is implemented in analytical and quantifiable self-instruction and self-inspection methods. • The main Building Performance, Project management and INSITER's effectiveness KPIs have been applied to the critical building components. • The main methods to measure the KPIs and parameters have been extended with analytical / calculation methods on critical building components. • Relevant stakeholders and their roles and responsibilities in the self-inspection process have been identified having studied the most common errors related to assembly phase (see matrixes Chapter 3, 4, 5, 6)
---	---

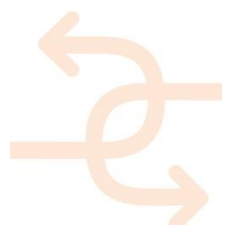
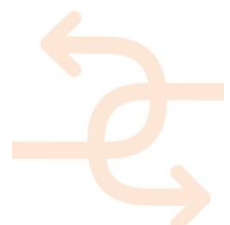

Table of Contents

1. INTRODUCTION	14
1.1 Objectives and structure of this deliverable	14
1.2 Positioning D1.4 within a project frame and WP1 deliverable map	15
1.3 R&D methodology employed to achieve results presented in this deliverable	17
1.4 Main achievements and limitations	17
2. DEFINING CRITICAL BUILDING COMPONENTS OF EEB	19
2.1 Research methodology: the European context and deliverable structure	19
2.2 Selection of critical building components for EeB performance	21
2.2.1 Impact of building envelope on energy efficiency	21
2.2.2 Building envelope components: classification and common issues	21
2.3 Construction failures	25
2.4 KPIs to be analysed	26
2.5 Main objectives of INSITER's investigation for EeB	28
2.6 How BIM serves Quality Assurance when mounting prefabricated panels	29
2.7 How Augmented Reality serves Quality Assurance during construction phase	30
3. CRITICAL EEB COMPONENT 1: FOUNDATION AND GROUND FLOOR	31
3.1 Analysis of foundation and prefab ground floor systems and relevance in workflow quality assuring methodology development for the building components of the foundation	31
3.2 Typical assembly process	33
3.3 Summary of most frequently made errors affecting quality and performance of EeB	34
3.4 Relevant INSITER KPIs and to-be-measured parameters for prefab foundation and ground floor system	38
3.5 Method to calculate the selected KPIs based on the measured parameters	44
3.6 Practical steps for self-inspection to measure the relevant parameters, including use of relevant measurement devices	44
4. CRITICAL EEB COMPONENT 2: BUILDING ENVELOPE – EXTERIOR WALLS AND BUILT-IN ELEMENTS	57
4.1 Analysis of prefab façade elements and relevance in workflow and quality assuring methodology development for the façade building components	57
4.2 Typical assembly process	59
4.3 Summary of most frequently made errors affecting quality and performance of EeB	60
4.4 Relevant INSITER KPIs and to-be-measured parameters for prefab façade elements (including use of measurement devices)	62
4.5 Measuring relevant parameters at different stages	65



5. CRITICAL EEB COMPONENT 3: BUILDING ENVELOPE – GLASS FAÇADES (CURTAIN WALLS) 68

5.1	Analysis of glazed curtain walls and relevance in workflow	68
5.1.1	Performance and quality requirements for glazed curtain wall assemblies	69
5.2	Overview of systems and typical assembly process	70
5.2.1	Main possible failures related to different type of assembly	71
5.3	Most frequently made errors affecting quality and performance of EeB	72
5.3.1	Deflection and geometric tolerances	74
5.3.2	Poor thermal performance	74
5.3.3	Humidity and moisture damages	75
5.3.4	Glass Failures	76
5.3.5	Poor acoustic performance	76
5.4	Relevant INSITER KPIs and to-be-measured parameters for prefab glass modules (including use of measurements devices)	77
5.4.1	Focus: calculation of heat transfer for glazed units	85
5.4.2	Focus: measurement devices and techniques	87
5.5	Calculation on KPIs	88

6. CRITICAL EEB COMPONENT 4: BUILDING ENVELOPE – ROOF SYSTEMS 89

6.1	General	89
6.2	Description of prefab roof systems	89
6.2.1	Level 1 - definition of intended use	90
6.2.2	Level 2 - identification of external and internal environmental conditions	90
6.2.3	Level 3 - definition of the coverage performance	91
6.2.4	Level 4 - choice of the type of coverage	93
6.2.5	Level 5 - choice and features of the elements and layers	93
6.2.6	The project covers with membranes with reflective trim	96
6.3	Summary of most frequently made errors affecting quality and performance of EeB	97
6.4	Relevant INSITER KPIs and to-be-measure parameters for prefab roof system (including use of relevant measurement devices)	100
6.5	Method to calculate the selected KPIs based on the measured parameters	105

7. CRITICAL EEB COMPONENT 5: CONNECTION BETWEEN NEW AND EXISTING BUILDINGS 106

7.1	Strategies overview and installation techniques	106
7.1.1	Addition strategy	107
7.1.2	Overlapping strategy	109
7.2	Installation techniques	110
7.3	Relevant KPIs	113
7.4	Quantifying KPIs (on-site)	114
7.5	Preliminary 'self-inspection procedures' in the refurbishment process	118
7.6	Testing on demonstration cases	122

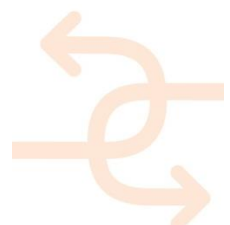

8. CONCLUSIONS	123
8.1 Key findings	123
8.2 Generalization, extension and applicability of the methodology	124
REFERENCES	126
APPENDIX 1 – PRINCIPLES OF PREFAB CONSTRUCTION AND FOUNDATION	127
APPENDIX 2 – EXAMPLES OF DIFFERENCES OF FOUNDATION AND GROUND FLOOR PER COUNTRY	129
APPENDIX 3 – EXAMPLES OF DIFFERENT PREFAB CONSTRUCTIONS	131
APPENDIX 4 - DESCRIPTION OF THE MOUNTING OF THE TIMBER FRAME ELEMENTS AND THE PROCEDURE TO GUARANTEE THE QUALITY	134
APPENDIX 5 – DESCRIPTION OF FOUR TYPES OF GLAZED WALLS	140
APPENDIX 6 - TYPICAL ASSEMBLY PROCESS (AS SELF-INSTRUCTION LATER ON)	146
APPENDIX 7 - ADDITION AND OVERLAPPING STRATEGY CASES	163

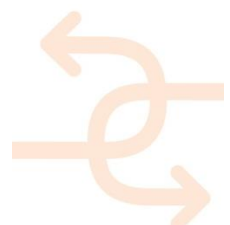

1. Introduction

1.1 Objectives and structure of this deliverable

This deliverable covers measurement aspects considering critical building components explained across several chapters. The following measurement aspects are analysed: thermal aspects; acoustic aspects; airtightness aspects; humidity aspects and geometrical aspects. The main objectives of this deliverable are:

1. To develop a method for measuring parameters of relevant KPIs of building components during the assembly phase.
2. To determine the calculation of KPIs measurement aspects regarding the overall performance of building components.

This deliverable is organized in eight main sections. Those are:

Section 1: Introduces the main deliverable's objectives; explains the research and provides an overview of the research and development methodology that is used to obtain the results. It provides an overview of the main achievements and limitations.

Section 2: Describes building components and why they are critical for energy performance; it focuses on the most frequently made errors and how INSITER can help improve.

Section 3: Focuses on prefab foundation and ground floor system; describing most frequent errors affecting quality and performance of EeB; describes relevant KPIs and to be measured parameters with a focus on geometric accuracy; provides practical steps for self-inspection to measure the relevant parameters including relevant measurement devices; proposes a method to calculate the selected KPIs based on the measured parameters.

Sections 4, 5, 6 and 7 follow the same structure as Chapter 3 only focusing on different building components and for them relevant KPIs measurement parameters.

Section 4: Focuses on the building envelope and analyses in a more detail air tightness (exterior walls).

Section 5: Focuses on the building envelope (glass facades) and addresses issues of geometric tolerance, poor thermal performance, humidity and moisture, glass failures, acoustic performance and heat transfer.

Section 6: Focuses on the building envelope and inspection to be done (roof systems).

Section 7: Focuses on the connection between new and existing and provides an overview of addition strategies and analyses heat transfer and thermal transmittance.

Section 8: Provides main conclusions and further research including interaction with other work packages.

Appendixes: First seven Appendixes provide additional analysis and background studies linked to different chapters and addressing specific issues related to building components. The last Appendix 8 includes the references/literature used throughout the chapters.

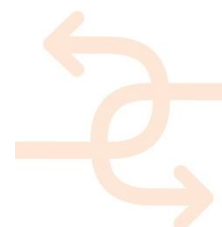

1.2 Positioning D1.4 within a project frame and WP1 deliverable map

Deliverables D1.4 and D1.6 (M24) are working in parallel and are dedicated to the building and MEP-HVAC components respectively. This deliverable (D1.4) focusses on the right connection of the exterior elements to each other and to the bearing construction. The Deliverable D1.6 focusses mainly on MEP/HVAC components. Since building envelope interacts with MEP/HVAC system, the main principles of this interrelation will be worked out in the upcoming deliverable D1.2 (M36) and D1.3 (M36).

The domain area of the deliverables D1.4 and D1.5 is given in Figure 1. The design errors and user errors are not the scope of this deliverable. The main focus is on errors during construction phase. At the same time there is a distinction of the activities being done in D1.4, which focusses on measuring and calculating and D1.5 (due M45), focuses on evaluating and deciding based on guidelines.

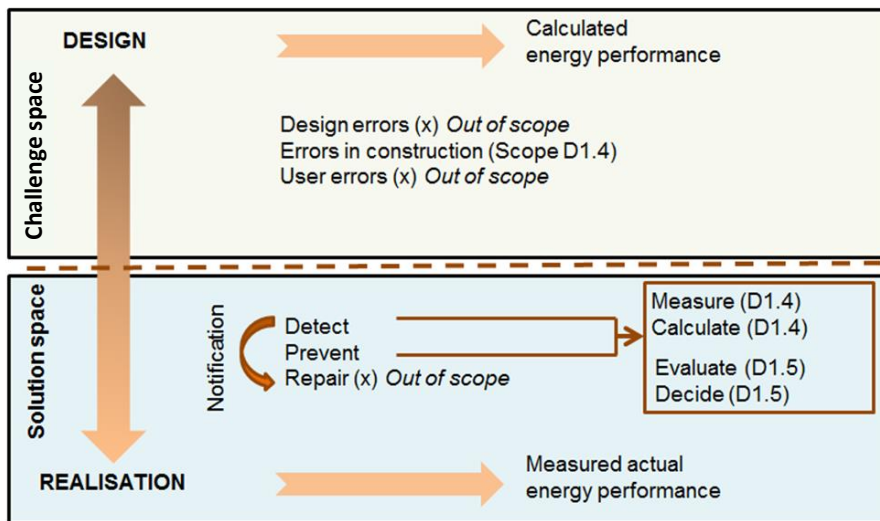
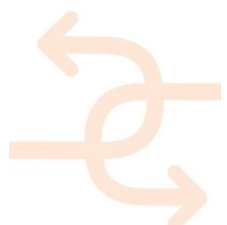

Figure 1: Domain area of the D1.4 and D1.5

This deliverable analyses which parameters need to be measured and works in parallel with work package on hardware monitoring tools (WP2), software tools (WP3) and BIM implementation (WP4).

WP 5 elaborates on the KPIs that measure the effectiveness of INSITER tool and validation activities. Various settings have different demands regarding INSITER tools. An overview of a whole WP1, including deliverables of month 12, month 24 and the upcoming deliverables in month 36 and 45 is provided in Figure 2.



WP1 – DELIVERABLE MAP

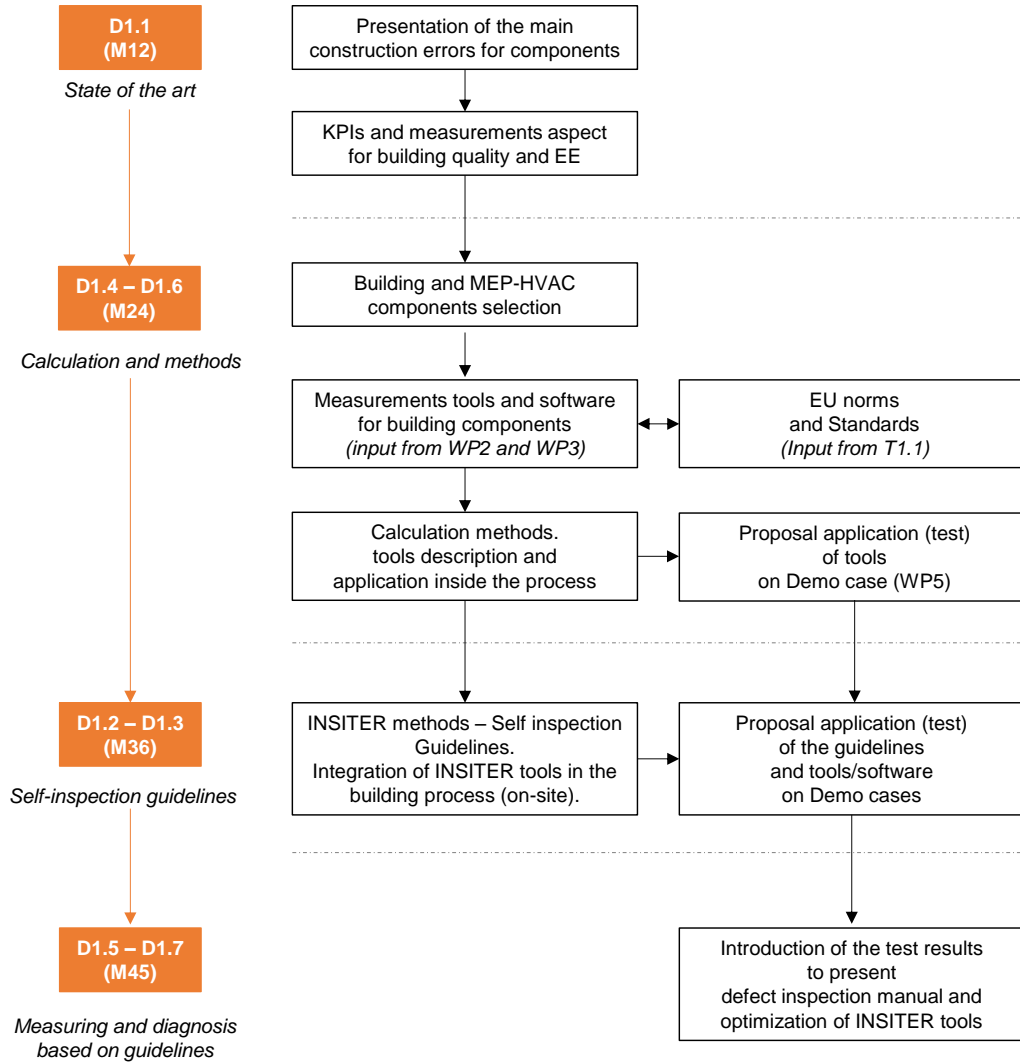
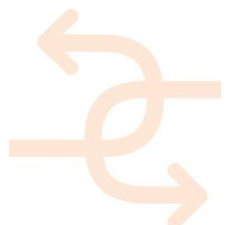

Figure 2: The scheme introduces the content map of the WP1 deliverables



1.3 R&D methodology employed to achieve results presented in this deliverable

Figure 3 summarizes the research and development methodology, starting from a selection of generic set of KPIs and relevant measurement parameters in relation to most common errors during construction process. These are analysed throughout five critical building components that enabled to reach conclusions regarding KPIs measurement techniques and method to indirectly calculate the measured values for KPIs.

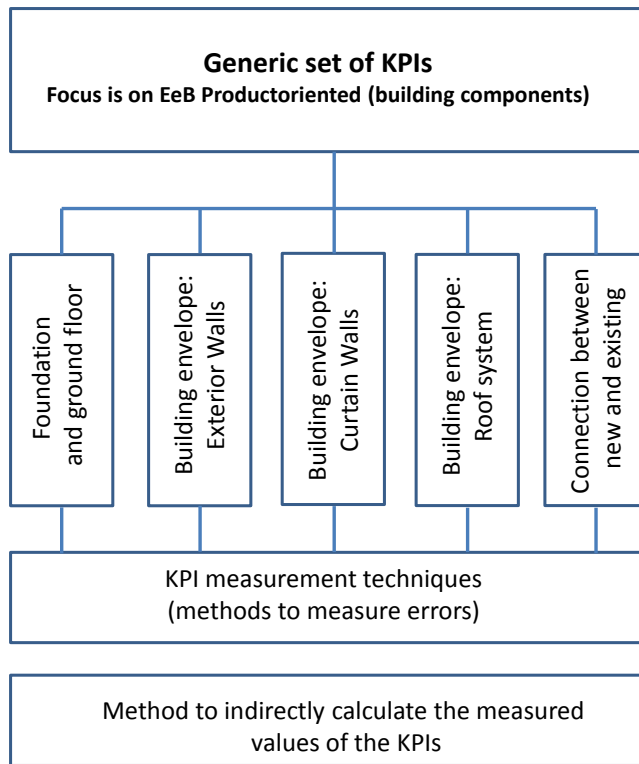

Figure 3: R&D methodology to achieve the results

1.4 Main achievements and limitations

The main goal of INSITER concerning KPIs and relevant parameters regarding building components is to simplify current practice. INSITER methodology proposes use of technology and different and a set of measurement tools in order to deal on time with potential errors occurring during construction phase.

The main technical challenges and how they are tackled are summarised as follows:

- Some errors occurring during construction process are not detected on time, yet in a total building, these errors have an accumulated effect, meaning that once a building is delivered. This deliverable focuses on the component level, yet the INSITER project as a whole deals both with challenges on component level as well as on building level to ensure that the expected performance is satisfactory within the range of a total acceptable threshold for particular KPI or a set of KPIs.

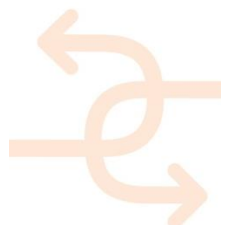

- Communication during the construction process is not straight-forward. This deliverable provides the insight into the collaboration processes during construction of building components. It contributes to the INSITER's objective to enable the construction workers to know whom to report to or how to employ technology to communication efficiently between different users and relevant parties.
- Once an error is reported, there may be a delay in construction process, since it takes a long time for a construction worker to explain precisely where the position of the element that is being mounted is or understand well the implication of that error for a total project. This deliverable identifies the solution to this issue at building component level, which contributes to resolving the issue at the whole building scale.
- When errors are detected, such as a major geometry problem or a connection problem that requires on-site continuous adjustments may extend the construction process and thus cause a delay. This deliverable presents solutions to prevent such a delay at the building component level, and thus it contributes to the way the INSITER project defining and developing methods to overcome these issues at the whole building scale.

Within the scope of the INSITER project and this deliverable, a comprehensive methodology is developed in order to deal with the abovementioned challenges, and more specifically, to reduce the amount of errors (by providing self-instruction) and to check the work as soon as possible (self-inspection) including feedback of errors to earlier stages which improves the future quality.

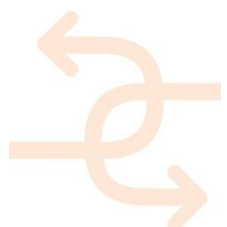

2. Defining critical building components of EeB

2.1 Research methodology: the European context and deliverable structure

This document is a result from WP1, Task 1.2, and contributes to methodological INSITER procedures as well as the use of tools and measurement techniques that are applied on self-instruction and self-inspection within the construction process of building components to ensure energy-efficiency and quality.

The main aim of this deliverable is, therefore, to define and prepare the basis to develop analytical and quantifiable methods which will contribute to building defect inspection manuals, respectively for new construction and refurbishment.

In these terms, it is therefore essential to first identify what are the building elements that can be identified as "critical" to achieve the performance criteria of quality and energy efficiency.

The first key-finding arises from the consideration that the quality and energy efficiency in construction concern a variety of aspects that involve, on one hand the complexity of a building as a whole and, on the other hand, the articulation of the design and construction process. Such approach is also strengthened and promoted by European legislation and in particular by EU directives concerning Energy-efficient Buildings (EeB). The two main EU directives and related objectives that have been addressed here as reference standards can be outlined as follows (Table 1):

Directive	Main objectives
<p>2010/31/EU Energy Performance of Buildings Directive, EPBD</p>	<ul style="list-style-type: none"> to promote the improvement of the energy performance of buildings within the Union, taking into account outdoor climatic and local conditions, as well as indoor climate requirements and cost-effectiveness. to require Member States to set performance standards for buildings. to require all new buildings, as well as buildings undergoing renovation, to meet energy codes and minimum energy performance standards (MEPS). to implement policies to improve the energy efficiency of existing buildings with emphasis on significant improvements to building envelopes and systems during renovations. to establish policies to improve the energy efficiency performance of critical building components in order to improve the overall energy performance of new and existing buildings. to encourage the application of energy performance certificates (EPCs) or labels to buildings that provide information to owners, buyers and renters. to ensure that from the end of 2020 only "nearly zero energy buildings" (NZEBS) are built.

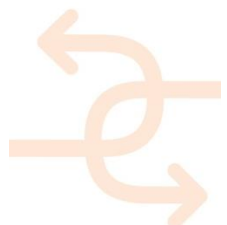

<p>2012/27/EU Energy Efficiency Directive, EED</p>	<p>to purchase energy efficient buildings, products and services in the public sector in EU countries.</p> <p>to promote that every year, EU governments will carry out energy efficient renovations on at least 3% of the buildings they own and occupy by floor area.</p> <p>to encourage EU countries to achieve the same level of savings through other means such as improving the efficiency of heating systems, installing double glazed windows or insulating roofs.</p> <p>to establish a set of binding measures to help the EU reach its 20% energy efficiency target by 2020.</p> <p>In general, under the Directive, all EU countries are required to use energy more efficiently at all stages of the energy chain from its production to its final consumption.</p>
---	--

Table 1: The two main EU directives addressed

From the analysis of this European legislative framework, the structure of this deliverable has been developed in order to adopt a common terminology and a shared approach in the context of all European countries.

Based on the interpretation of the EPBD and the EED, the aspects that influence energy efficiency consist of:

1. Avoiding excessive and unnecessary use of energy through regulation.
2. Reducing energy losses by implementing energy efficiency measures and new technologies.
3. Monitoring energy consumption to improve knowledge on energy consumption patterns.
4. Managing energy consumption by improving operational and maintenance practices (Morvaj and Bukarica, 2010).

In this deliverable's context, aspect 2 is mainly relevant, since it contributes to the definition of buildings critical elements: in this perspective, the building envelope becomes the most crucial part when it comes to energy efficient buildings. However, it shall be highlighted that, in a holistic approach, the proper performance of the building is determined by the mutual complementarity between the building elements (addressed in this deliverable) and system components (developed in D1.6). When buildings are constructed or renovated, a whole-building perspective is preferred, which involves considering all parts of the building and the construction process to reveal opportunities to improve energy efficiency. For new buildings, materials and energy equipment integration already allow low energy demand but investment costs must be reduced. For refurbishment, a whole value chain innovation process is required where design, technology and construction are even more intertwined than for new buildings. Numerous whole-building perspectives and policy mechanisms exist, such as building performance certificates (IEA, 2013)¹ and whole-building labelling programs, but they are beyond the scope of this deliverable, which will focus on the building envelope components and their mutual relationships.

¹ Transition to Sustainable Buildings: Strategies and Opportunities to 2050 (IEA, 2013a) and Modernizing Building Energy Codes to Secure our Global Energy Future (IEA-UNDP, 2013).

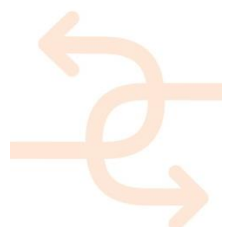

2.2 Selection of critical building components for EeB performance

2.2.1 Impact of building envelope on energy efficiency

The building envelope – the parts of a building that form the primary thermal barrier between interior and exterior – plays a key role in determining levels of comfort, natural lighting and ventilation, and how much energy is required to heat and cool a building. The building envelope impact on energy consumption should not be underestimated: globally, space heating and cooling account for over one-third of all energy consumed in buildings, rising to as much as 50% in cold climates and over 60% in the residential sub-sector in cold climate countries². The envelope design and construction also affects the comfort and productivity of occupants.

When buildings are constructed or renovated, a whole-building perspective is preferred, but in many situations only partial interventions are provided. For instance, in the case of existing buildings that need to be maintained in use during the works, the proposed work items may be limited to a refurbishment of the envelope, that involves all parts of the building or is only limited to specific components, such as replacement of windows, of the roof, or the installation of insulating elements for the walls.

Although it is easier to get results in new buildings, even on major renovations and building additions satisfactory levels of energy improvements can be met: energy consumption can be reduced by up to 70-80% by insulating the exterior walls and roofing systems of the building³. The first step is a systematic set of survey, inspection, collection and analysis of parameters related to the specific consumption, related to the operating conditions of the building and its facilities and technical and economic evaluation of energy flows.

2.2.2 Building envelope components: classification and common issues

The building envelope has been subdivided into several sub-systems, each with their own characteristics. Following the workflow of the construction process, all elements of the building envelope that affect energy use have been identified, and the classification has been made as follows (Figure 4):

Foundation and ground floor, including foundation connection and façade connection. The ground floor elements including their foundations are considered as a specific sub-system because of the constant contact with the soil and corresponding risks of performance loss.

Solid prefab façades, including window openings (façade – frame). The vertical elements mainly present problems of connection with the background building structure and with the connection between different modules.

Glass façades (curtain walls). These kinds of components present similar issues to solid facades in terms of air tightness and general performance (from acoustic, thermal points of view). In addition, they present specific problems related to the presence of glass panes and sealings.

² Energy statistics in this roadmap come from the IEA energy balances, IEA Energy Efficiency Indicators Database, and the IEA Buildings Model unless otherwise stated (IEA, 2013a).

³ Enea, 2014

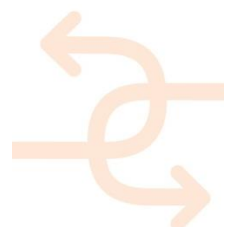

Roofing systems. These elements can be flat or inclined. Flat roofs are vulnerable for accumulation of water whereas the inclined roofs have to deal with run-off water. Roofs are critical in terms of energy savings especially regarding heat loss and waterproofing. The performance analysis of the roof elements also includes their connection to the vertical façade elements.

Connections between existing building and new elements. Refurbishment processes have been identified as involving envelope configurations: in this perspective, an additional section has been included in the deliverable, mainly focusing on the connection between new and existing.

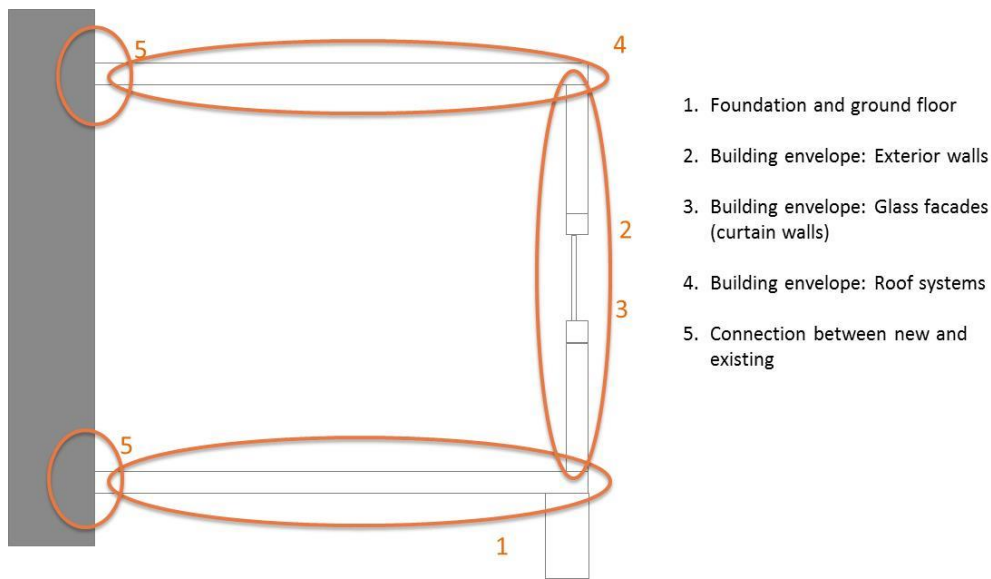

Figure 4: Subdivision of building systems as studied in this deliverable

Next to these 2-dimensional drawings a representation of building envelope components affecting energy performance are given in Figure 5.

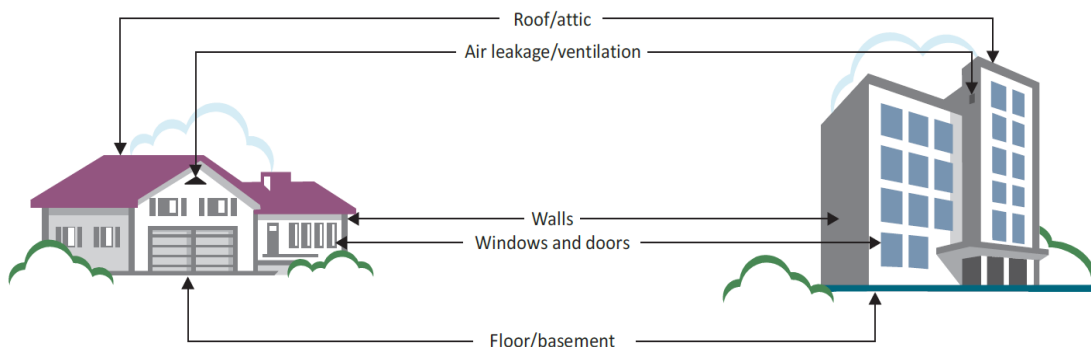
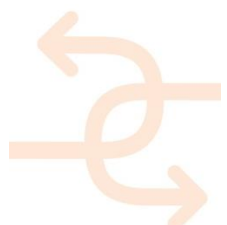

Figure 5: Building envelope components affecting energy performance



In the development of inspection procedures for building envelopes, in case of new construction, refurbishment or assessment phase, two key-aspects that influence the behaviour of the “skin” of a building are represented namely by (a) the consistency of tolerances and (b) the status of joints and connections: the interface between different elements primary affects the actual performance of installed building components.

Tolerances can vary depending on the materials and products: the respect of dimensional tolerances ensures mechanical resistance, and provides functionality and compatibility of each element with the rest of the structure and other non-structural components. Some reference norms or guidelines (i.e. UNI EN 13369: 2013 Common rules for precast concrete - Annex J) define geometric constraints, surface imperfections, metering modes and permissible deviations from the surface of a prefabricated element, but many products do not have an applicable standard. The definition of procedures is specifically important on construction site, where regular inspections should be carried out to ensure that specified requirements are met.

Regarding **connections**, different forms of connection can be identified, between the components that constitute the envelope itself (internal connections) and between the external skin and the supporting structure of the building or other parts of the building, such as the basement and the roofing system (external connections). The forms and methods of connection vary in relation to the materials and products used, to the structural type of the building, as well as to the number of functional layers of which the envelope system is made. In general, for instance, in prefab buildings, the vertical wall elements can be inserted between the meshes of the structural frame, or can be hung outside, directly fixed to beams and pillars or bound to an additional secondary supporting structure.

In order to reduce complexity several assumptions are made which had an influence on further methodology development:

1. The prefabricated elements and systems are produced in the factory and are ‘errorless’ meaning they are 1) already tested in the labs, 2) satisfy the performance requirements/comply with quality assurance, and 3) are not damaged during production. All elements have geometry differences, but dimensional tolerances should be within a certain limit. Next to this, not only dimensional tolerances of the element are important but also of the openings where the element will be placed. Junctions where the tolerances are not acceptable and therefore cannot be solved on a site, due to discovered larger geometry difference than allowed, need to be returned to the factory. This requires development of communication protocols towards the factory and possibly cancelation of delivery of other components where similar mistakes are expected. If it does appear that there is a design error, the INSITER will not solve this issue, other than instruct to return to the factory.
2. The pre-fab components might be consisting of: wood, steel/aluminium, concrete, polymers and a variety of composites created by a cross-over of the above mentioned material choices. Since we deal with the prefab systems, independent of the materials used, the performance and quality assurance of the system should be according to national standards, and particularly in INSITER context referring also to assessment and implementation guideline. These last two set of documents are important since we rely on the quality agreements of the sectors/sections for wood, metal, plastic and sandwich elements. It is a system that satisfies performances already tested in the labs. This is the reason that the methodology and tools that are developed in this project are generic enough and are independent of materials of which the system is composed.

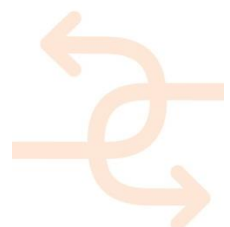

3. Elements that arrive on a site might be damaged during transportation and need to be inspected on-site for damage. The communication protocols for this self-inspection will be developed in this deliverable and in relation to Key Performance Indicators.

For this purpose a four-step approach is introduced:

- i) **Pre-fab as designed** (internal quality assurance at factory level);
 - ii) **Delivered as pre-fab**: self-inspection phase 0 before mounting at arrival on site, just identification of the element and at random the inspection of the element;
 - iii) **Mounted as delivered** –the assumption should be that there is no storing on site but just in time mounting- this is the point where it comes to measurement in case of foundation diagnosis of geometrics as a prep action;
 - iv) **Performing as pre-calculated**, this is focusing on building physics and all measurement devices have to be applied that help to analyse possible errors, balance their relevance and to decide if they are acceptable. The problem identification and qualification (acceptable/not acceptable) is a part of INSITER, but it is important to mention that the solution is ***not*** included in INSITER and is not a scope of the INSITER project.
4. The received prefab elements on site are regarded as errorless (a façade element including windows and doors). Nevertheless, it is necessary to perform random tests on site for quality assurance.
 5. Junctions, which in this projects are defined as 3D junctions, are most crucial parts and are the places where potential errors may occur, namely in a form of gaps that can have an impact on energy performance of the building. This has to be solved on-site. Nevertheless, 2D connections are important as well when analysing critical components.

Regarding this, a 'joint approach' has been developed in order to study the building components and reduce the problem complexity. This approach is given in Figure 6.

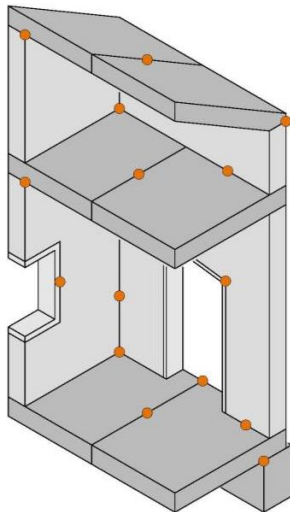
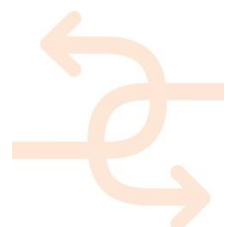

Figure 6: 3D allocation model of characteristic construction errors: joint approach



2.3 Construction failures

The individual building envelope components and the related issues will be analysed in detail in the next sections, since analysis and methodological approaches of building envelopes is complicated by the extreme diversity of building materials, climates, standards and practices of building design and construction. However, the evaluation of the most common deficiencies in the construction of the building skin can be generally outlined, on the basis of INSITER previous achievements (Piaia, et. al., 2015), literature review and current practice. As further development of such consideration, some critical and recurring inefficiency, grouped by general categories, can be outlined (Table 2):

Main common inefficiencies	Major effects (qualitative assessment)
Geometric discrepancies	Undesired gaps, water/vapour infiltration with related interstitial condensation
Lack of insulation	Low U-value, thermal bridges
Lack of air sealing	Thermal bridges, water/vapour infiltration
Unexpected heat gains through transparent surfaces	Sensitivity to solar radiation, surface condensation, glare

Table 2: Critical and recurring inefficiencies

Therefore, the resolution of the above-mentioned issues can result in significant enhancements and consist in crucial impacts on energy performance, as summarized in Table 3:

Component/ interface	Impacts on energy performance
Walls Roof Basement floor	High levels of insulation in walls, roofs and floors, reduce heat losses especially in cold climates, optimized through life-cycle cost (LCC) assessment. Highly reflective surfaces are beneficial in hot climates, including both white and “cool-coloured” roofs and walls, with glare minimized
Glass facades	High-performance windows/facades, with low thermal transmittance for the entire assembly (including frames and edge seals) and climate-appropriate solar heat gain coefficients (SHGC)
Interface (joints and connections)	Properly sealed structures ensure low air infiltration rates, with controlled ventilation for fresh air. Minimization of thermal bridges (components that easily conduct heat), such as high thermal conductive fasteners and structural members, while managing moisture concerns within integrated building components and materials

Table 3: A summary of building components and their influence on energy performance

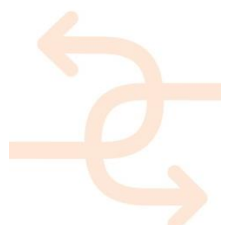

In this context, INSITER's contribution, and WP1 in detail, can be beneficial in providing an integrated approach with BIM technologies: in particular, the present deliverable will provide a preliminary definition of the steps for self-inspection procedures (including use of measurement devices that give quantitative results), that will be then implemented in the follow-up deliverables.

The list of errors and including a description of each error has been presented in the previous deliverable (D1.1). As a summary, the construction errors are listed below:

- Offsite manufacturing in conflict with the design
- Poor manufacturing of the buildings components
- Onsite manufacturing in conflict with the design
- Assembly of damaged building components
- Incorrect or mistaken assembling of the building components
- Poor component locations or improper installation
- Misinterpretation of incorrect use of the documentation (e.g. technical drawings)
- Omission or assembly of building components differing from the final design
- Geometric problems of the building components
- Installation of unsuitable material
- Windows and doors incorrectly sealed on-site
- Irregular site inspection by the project manager

Each chapter of this deliverable will outline the assembly process for each building component, including maintenance and service life phase. After that, the main construction failures affecting the selected building element will be analysed in detail in order to map the main problems and identify at which stage of the workflow they occur.

2.4 KPIs to be analysed

Key Performance Indicators “say” something about the performance of the building itself, e.g. air leakage, sound insulation, regarding building quality as well as energy performance.

Two main aspects are addressed as relevant for the building envelope: *Energy Efficiency* and *Indoor Environmental Quality*. *Energy Efficiency* is a ratio between an output of performance, service, goods or energy, and an input of energy. In other words, it means using energy in an efficient way to provide healthy and comfortable buildings. In this deliverable's framework, only passive approach has been developed in order to focus on EeB components. INSITER aims to eliminate the gaps in quality and energy-performance between design and realization. For that purpose, “quality” is defined as *Indoor Environmental Quality*.

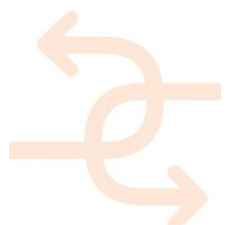

Therefore, the following KPIs are selected:

The *Energy Efficiency* related KPIs focus on:

- Heat transfer of the building envelope;
- Efficiency of heat/cold generation;
- Efficiency of heat/cold distribution.

For *Indoor Environmental Quality* the following main aspects are taken into account:

- Thermal comfort;
- Visual comfort;
- Acoustics;
- Air quality.

It should be also stressed that some common aspects are relevant for the energy performance of all building components:

- Geometry, intended as flatness, sagging, creep, shrinkage or thermal movement are the primary features that need to be addressed and verified on site.
- Air sealing, intended as restricting the passage of air through the building envelope, is a key way of increasing energy efficiency during new construction and deep renovation. It is vital to validate the results of air sealing by carrying out standardized tests of its effectiveness. Air sealing alone can reduce the need for heating by 20% to 30%. Tightly sealed structures with proper ventilation control can ensure the indoor climate is healthy. Energy audits, such as the energy performance certificates that are mandatory in the European Union, should include regular, validated testing of air leakage (e.g. at least every 10 years).

This deliverable has also analysed the process framework, and identified two main stages in which the choice of building components are critical for Energy Performance and therefore when KPIs, with related parameters, need to be measured: construction/assembly processes and performance analysis/assessment.

Construction and assembly processes are now part of the critical path to reach the final energy performance. Any defect can lead to disorders and even pathologies which hamper the durability of the building performance. Several complementary routes can be envisaged i.e. prefabrication of standard units which facilitate field integration, new field integration process with more detailed internal performance control, new sensors to check intermediate performance steps, continuous improvement processes as part of a quality process, training of workers on the impacts of a wrong installation on the final energy performances.

Performance assessment (for existing buildings) enables users/owners/investors to oversee and control energy consumption and behaviour, allows detecting potential misuses of buildings due to a lack of awareness of the users, potential disorders and/or pathologies of the monitored building. Moreover, conditional maintenance approaches can bring added value in guaranteed performance contracts. This phase is fundamental not only for maintenance purposes, but especially in the multi-criteria approach to refurbish and improve existing facilities.

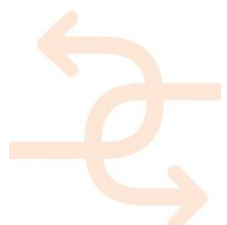

2.5 Main objectives of INSITER’s investigation for EeB

Within the building envelope, there are a number of performance aspects to monitor and inspect. KPIs are usually checked through numerical data of energy consumption or building performance characteristics that can be evaluated across multiple energy operations. Numerous techniques exist to capture and assess significant parameters, but first, it is fundamental to establish a baseline, identify fair comparable and establish achievable targets.

Using INSITER protocols, measurement systems that have an impact on energy performance have been selected and grouped in three main categories:

- Geometric discrepancy/humidity;
- Positioning/sensing;
- Thermal/imaging.

Protocols are grouped as follows:

- Protocols for thermal test;
- Protocols for acoustic test;
- Protocols for geometric discrepancy test;
- Protocols for humidity test;
- Protocols for positioning system test.

The analytical methods to take measurements and the application are outlined below; highlighting which techniques and tools shall be used. Each chapter will list the selected tools, depending on each critical building component (Table 4):

Measurement parameters	Sensors / Measurement tools	Aim / measurement aspects
Thermal contrast [K]	Thermal Camera	Structural Integrity
Dimension difference [m]	3D Laser Scanner	Geometric discrepancy
U Value [W/m ² K]	Thermal Camera, Heat Flux Transducer	Thermal transmittance
HD [W/K]	Thermal Camera	Thermal Bridge
Index of reflectivity L	3D Laser Scanner	Humidity

Table 4: An overview of measurement parameters, tools and measurement aspects

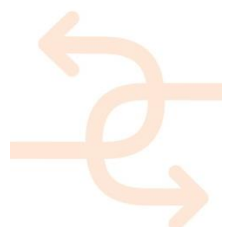

2.6 How BIM serves Quality Assurance when mounting prefabricated panels

When it comes to Quality Assurance regarding the assembly of prefabricated building elements BIM is capable of improving processes significantly. Within the process between fabrication and assembly of construction elements BIM will be used to avoid critical errors, to reduce efforts in case prefabricated elements have to be exchanged and to gain transparency and traceability for construction errors:

1. Avoiding critical errors

Prefabricated panels may be equipped with a QR code where the link to a specific BIM object is included. This will enable the site worker to verify the correctness of prefabricated panel via scanner according to the design. The assembly of wrong panels will be avoided.

Additional assembly information like instruction documents and videos may be linked to the BIM model to prepare site workers for assembly. This will avoid errors while mounting the prefabricated panels. In combination with AR this will be even more beneficial.

After fabrication there is a quality check at the factory to guarantee that the measurements of the panels are within the allowed tolerances. Entering exact measurements information for each panel to the BIM directly at factory will allow verifying that mounting several panels adjacent to each other will not sum up the variations to a critical value in total. Critical accumulations of deviations will be avoided.

Slight deviations in the measurements of the panels might easily be evaluated in BIM. Comparison of exact measurements of the fabricated panels of a series enables the factory workers to detect production errors. This avoids continuous production errors.

2. Reducing efforts for exchanging defected components

If prefabricated panels will be damaged while delivery information about the defect can be entered to the BIM model. All available information about the defect will be available to all users of the BIM information system.

While having all related information at hand countermeasures for fixing the issue can immediately be initiated. Delays will be avoided or at least minimized.

Due to the fact that all information about defects as well as information about initiated countermeasures are available the time scheduler will be enabled to adjust the time schedule without delays.

3. Transparency and traceability of construction errors

Accumulating defects in a BIM database will enable the construction team to identify common errors. This will enable the optimization of processes and avoiding those issues.

Gathering information about common errors will enable other projects to avoid those issues right from the beginning of their projects.

Therefore, self-inspection and self-instruction methodologies will be based on BIM in INSITER project.

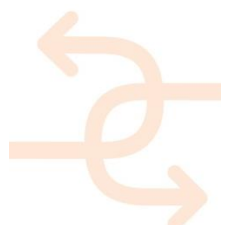

2.7 How Augmented Reality serves Quality Assurance during construction phase

As with BIM, AR in combination with INSITER tools will enhance the capabilities of any actor or stakeholder on-site for self-inspection and self-instruction in an efficient and effective way. AR can be applied to visualize in-situ required information, digital planning data, 3D building models and components as well as instrumentation data from diagnostic instruments and devices, enabling monitoring, evaluation, quality control and improvement of assembly & construction work.

BIM-based assembly and construction instructions can be visualized superimposed and directly projected into the field of vision of the user, including real-time part recognition and tracking, which enables e.g. to display the defined assembly location and thus to guarantee the correct construction, building quality and safety. Step-by-step work instructions and error prevention capabilities with an identification of the current parts and material to be used is supported by BIM and AR (see deliverable D2.1 for further information). Furthermore, instrumentation data from applied INSITER diagnostic measurement systems made available and referenced via BIM can be visualized on-site for further evaluation, quality validation and assurance during the construction processes (see deliverable D2.3 for further information on the INSITER “Toolset of capturing, measurement and diagnostic systems for self-inspection”).

A particular emphasis being placed in INSITER is on BIM-based visualization of models, construction processes and instrumentation data for validation and error prevention as well as the provision of referenced planning data for self-inspection and self-instruction for on-site actors and construction personnel. The INSITER toolset and BIM applications in combination with AR will be beneficial to quality assurance and the construction process by avoiding critical errors in multiple aspects, especially such as:

Enhanced benefit for applying BIM in combination with the use of AR, by equipping prefabricated panels with e.g. markers or object based tracking to reference specific BIM objects and related planning data.

- This will enable the direct superimposed visualization of BIM construction elements with a visualization of the defined assembly location and linked in-situ work instructions, critical installation aspects and relevant instrumentation data to be considered for an error free construction process.
- In combination with BIM, the e.g. the assembly of e.g. wrong panels will be avoided more effectively and site worker can verify the correctness of prefabricated panel according to the provided BIM-based information.

Any report of quality aspects or self-inspection feedback can be given through INSITER framework by e.g. select the corresponding BIM object and start-up integrated INSITER tools such as the “RE Suite inspection tool”. Within the INSITER toolset any information concerning quality issues or planning deviations can be attached to BIM models and referenced.

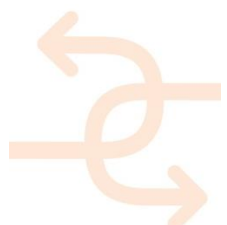

3. Critical EeB component 1: Foundation and ground floor

3.1 Analysis of foundation and prefab ground floor systems and relevance in workflow quality assuring methodology development for the building components of the foundation

The focus of this chapter is on the following five characteristic points of junction:

1. Joint between floor construction and foundation
2. Geometrical accuracy of the prefab floor slabs
3. Joint between two prefab floor slab elements
4. Joint between floor element and wall element

This is realised through a typical assembly process followed by most frequently made errors affecting quality and performance of EeB.

Examples of differences of foundation and ground floor per country are provided in Appendix 2. Those are more detailed examples, but within the scope of the INSITER material level and exact ordering is not the focus of the INSITER project.

With regard to the scope, in the INSITER project that focuses on prefab construction elements that are used in the building envelope the following assumptions and definitions are made:

In general ground slabs of constructions with basements are made not in prefab but as an in-situ construction. These concrete parts of the building will not be regarded as building elements in the scope of INSITER. The result is that in this chapter exclusively the prefab construction of the ground floor (either with an unheated basement or a crawl space underneath it) and the structural connection with the foundation, as well as detailed solutions for a building envelope that is preferably tight, is analysed.

The first activity on site is the preparation for the delivery and mounting of the prefab elements and the realisation of the ground floor connection. The prefab production process at the factory if prefab foundation elements are used is not analysed within the scope of this chapter. Nevertheless the assumptions related to the prefab process of the prefab elements at factory level are crucial for further development of quality assuring methodologies (see chapter 3.5).

The most important assumption for the analysis of the different building parts by their position is that all prefab elements are perfectly and errorless produced when they leave the factory.

The following stepwise analysis of the process and assignment of calculation and analytical methods of the building components related to the foundation and ground floor is based on the description of the INSITER 8-step methodology (has been explained in the previous deliverable D1.1).

The workflow scheme of this investigation starts with the site preparation mapping, the support of any building site logistics, the check of the already built foundation and the connection of the panels to the foundation.

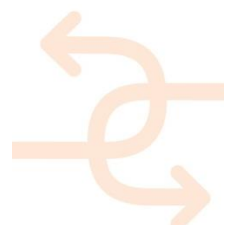

The quality thresholds are related to technical performance as correct structural connections and fixings, and all features influencing the air tightness of the envelope and the avoidance of any thermal bridges. These quality thresholds have to be assured by self-inspection.

Principles of prefab construction systems in housing and in industrial buildings and their influence on foundation design and construction are explained in Appendix 1.

Many or even most prefab buildings are mounted on a concrete in-situ construction (ground slab foundation/strip foundation) at ground floor level as building in this manner is very stable and has a high resistance against moisture and air leakage if done properly. This construction -in-situ- is not analysed in this chapter as INSITER is focusing exclusively on prefab constructions and in this chapter prefab constructions of the ground floor are regarded.

The foundation -whatever construction was chosen (depending on geological parameters mostly produced with in-situ reinforced concrete, sometimes in combination with masonry) has plain topside.

On this topside the prefab construction of the ground floor and the exterior walls are supported and mounted.

The technical requirements of the foundation are in the INSITER context primarily about the geometric accuracy of these building parts influencing the connection. It can be assumed that the comparably low requirements that have to do with material properties -e.g. quality of the concrete and the reinforcement choice- are fulfilled a priori and do not have to be tested, as they are as aforementioned usually not prefab constructions and as they are no frequent malfunction source. Nevertheless in terms of documentation needs the concrete quality could be checked by a Schmidt-Hammer –rebound hammer.

Prepared and embedded fixings -e.g. metal plates or linear fixings as cast in Halfen channels- should be checked regarding their appropriate position –by laser scanning/measuring- and their tolerances related to the foreseen mounting level by laser levelling in order to check the accepted tolerance level by the used construction methodology.

At the time the prefab elements for walls and floors are delivered to the building site, a first quality check starting with the identification of the prefab element is done. However the basic thesis of the follow up survey is that the prefab panels are leaving the factory without any construction errors and are perfectly produced as a “produced as modelled” element by the use of enhanced BIM application at factory level. The conclusion is that the demands of the perfect envelope in energy related issues is well prepared at element level but the connections and fixings of the elements and the “plug-and-play” connections for HVAC and MEP are a possible source for construction errors. The analysis of HVAC and MEP oriented construction errors are with in deliverable D1.6 Calculation and analytical method for inspecting MEP/HVAC components.

By taking a picture of a label or scanning a barcode the element is precisely identified on site. Information related to “delivered as produced” shows the characteristics of the element –material used, quality of building physic performance e.g. thermal performance, sound insulation and other related building physic data, embedded pipes for installation, production tolerances, adjustments or deviations at the factory workshop, other production data documentation- and a checklist of a visual inspection supported by the INSITER tool is processed. The objective is the documentation and qualification of possible damages caused by transport and site logistics. The quality check is following the features of the element description embedded in the BIM based documentation. The check is needed to decide at an early stage about the acceptable difference in quality between “produced as modelled” and “delivered as produced”.

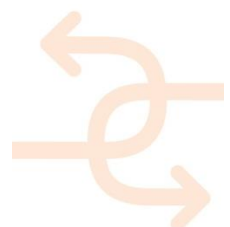

The target is to decide quickly whether the element should be mounted or has to be rejected in terms of not acceptable level of quality. The thresholds will be added to the BIM model of the panel and can be balanced against the existing state of the art –quality level of the delivered panel on site- at any time.

A 3D allocation scheme was developed (see Figure 6 in previous chapter) in order to allocate qualifying needs of performance for quality checks without focusing on a material oriented prefab building system. The characteristic points of junction are: the connection of the floor panel to the foundation and the joint of the floor panel to another. The objective is to provide a reliable fixation and a perfect thermal and sound insulation at the same time and to realise an air tight envelope by closing the gaps between the panels.

3.2 Typical assembly process

The assembly process and the follow up of steps described below are focusing on the building process related to the targeted prefab element mounting, from preparation to realisation.

The follow up steps from scratch on site are:

1. Building surveying and positioning
 2. Excavation
 3. Levelling of the foundation level
 4. Granular subbase building
 5. Formwork build-up. Concrete-footing ground electrode implementation
 7. Reinforcement
 8. Concreting and addition of fixation panels for floor element or wall joints
 9. Curing process
 10. Formwork removal
- (Alternatively, steps 5 to 10 are replaced if prefab concrete elements are applied)
11. Levelling check and possible adjustments
 12. Waterproofing layer
 13. Mounting of floor or wall element (if the slab foundation is applicable the wall element will be mounted)
 14. Addition of next element fixed to the foundation and to the neighboured element
 15. Repetition of the process
 16. Closing of the gaps between the elements (horizontally/vertically)
 17. Quality check
 18. Adjustment
 19. Addition of load bearing interior walls
 20. Mounting of ceiling elements

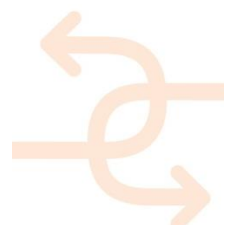

3.3 Summary of most frequently made errors affecting quality and performance of EeB

The error identification is devoted to the stepwise approach described in 3.2 above. There are construction errors related to the responsibility of the contractor delivering and mounting the prefab panels -scope of INSITER- and related to other service companies. Nevertheless the "external" influence on quality performance and assuring issues is relevant for the analysis of the importance and the relevance of the partners performing. Therefore the list of follow-up steps will be commented in this chapter from another perspective.

1. Building surveying and positioning

- Inaccurate positioning of the building;
- Inaccurate levelling causing drainage problems;
- Inaccurate geo-data for neighbourhood positioning -e.g. no chance of keeping the distance by building law.

2. Excavation

- False excavation level;
- Foundation (level and size) is calculated on basis of other load bearing capacities of the building ground;
- Special findings e.g. ground water level higher than expected, inconsistent character of the soil is not documented;
- Soil monuments are found but not reported;
- Soil contaminations are not reported;
- War contaminations are not reported;
- Ecological impact of special findings is not reported, protected animals.

3. Levelling of the foundation level

- Wrong levelling;
- Special finding -pipes - not taken in to account for levelling of excavation level;
- Public drainage level not fitting to building drainage level.

4. Granular subbase building

- Wrong levelling;
- Wrong material choice.

5. Formwork build-up

- Wrong dimension;
- Wrong levelling.

6. Concrete-footing ground electrode implementation

- Wrong positioning;
- Just forgotten.

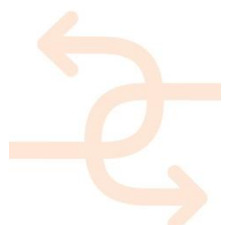

7. Reinforcement

- Wrong material quality;
- Less than calculated;
- Coverage of concrete at the edge too small.

8. Concreting and addition of fixation panels for ceiling or wall joints

- Wrong position;
- Wrong material;
- Wrong level;
- False connection offer.

9. Curing process

- Too short;
- Weather conditions: no extra water in hot weather.

10. Formwork removal

- Too early;
- Causing damages.

(Alternatively steps 5 to 10 are replaced if prefab concrete elements are applied)

11. Levelling check and possible adjustments

- Choice of the wrong adjusting material;
- Wrong levelling related to the thresholds;
- Adjustments not fitting.

12. Waterproofing layer

- Wrong material choice;
- Thickness not fitting to the mounting tolerances of the prefab elements;
- Bad connection between waterproofing layers.

13. Mounting of floor or wall element (if the slab foundation is applicable the wall element will be mounted)

- Wrong fixing material used;
- Bad positioning of the element;
- No balancing of tolerances from the start;
- Wrong element at the foreseen position.

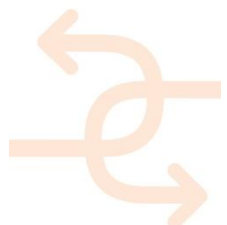

14. Addition of next element fixed to the foundation and to the neighboured element

- Wrong fixing material used;
- Bad positioning of the element;
- No tolerance check;
- Wrong element at the foreseen position;
- No extra fixation for the building process until the structural system is stable;
- Preparation or closing the gap and checking the air tightness and the complete infilling of material.

15. Repetition of the process

- See above.

16. Closing of the gaps between the elements (horizontally/vertically)

- Filling material wrong;
- Gaps too big;
- Gaps too inhomogeneous;
- No thermal check;
- No acoustic check.

17. Quality check

- Not done;
- Just formally done but no follow up action: defect report;
- Not appropriately done;
- Wrong tool application;
- No documentation;
- No formal acceptance;
- No informal acceptance process by the contractor;
- No gratification system for construction error finding but for error free performance.

18. Adjustment

- Lowest level trouble shooting (client just satisfied and not complaining anymore but not real quality oriented);
- Short term solution in terms of warranty by law performance;
- Not qualified personnel in terms of sustainable solution .

19. Addition of load bearing interior walls

- Wrong positioning;
- Wrong elements;
- Load bearing connections are missing;
- Connections with exterior wall (envelope) cause thermic and acoustic problems.

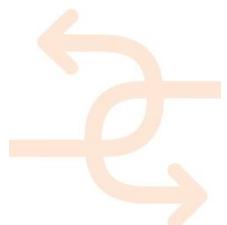

20. Mounting of ceiling elements

- Wrong positioning;
- Wrong elements;
- False structural connection;
- Bad levelling;
- Missing appropriate sound insulation in case of bad connection.

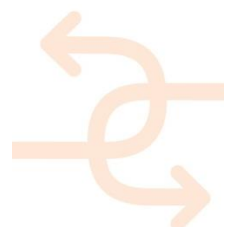

3.4 Relevant INSITER KPIs and to-be-measured parameters for prefab foundation and ground floor system

Generic technical requirements for realising quality assurance at building envelope level:

- a) Dimensional accuracy / joints / tolerances
- b) Thermal transmittance reduction (U-value)
- c) Structural Stability:
 - Bending
 - Support (e.g. bedding depth)
- d) Air tightness (thermal relevance) (3D/4D -Sd)
- e) Water- and vapour-resistance (μ)
- f) Sound insulation of the facade (dB)
- g) Fire security (min)
- h) Appropriate material choice and application

Relevant measurements to be applied related to KPIs and parameters:

- 3D laser scanner, GPS, sound brush, photograph, Geometrical accuracy in m, cm, mm; position identification in geo data format; U value in $W/m^2 \times K$ and air density in terms of air leakage of gaps between elements, N50-value 1/h Airflow m^3/s ;
- Thermal camera, thermometer, U value in $W/m^2 \times K$;
- e.g. Rebound hammer (concrete) N/mm^2 ;
- Sound brush, blower door test, air flow capture hood, air velocity meter;
- Moisture meter, humidity in relative moisture description in %;
- Microphone, sound intensity in dB;
- Thermal insulation, dimensional accuracy U value, m, cm, mm;
- Documentation of produced as modelled, excel sheet of material description.

The relevant norms and methods are listed at Piaia, et. al., 2015, chapter 2.5.

Calculation of KPIs parameters

The relevant KPIs are measured and checked against a predefined target value or threshold based on the national, regional or local individual needs of building systems, regulations and craftsmen qualification offered by the contractor in charge.

Typical errors during assembly phases and KPI assignment are summarized in the following sections related to:

- Foundation;
- Joint ground floor foundation;
- Accuracy of ground floor element;
- Joints ground floor element;
- Joints ground floor /wall.

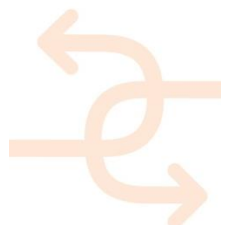

1. Foundation

The critical quality aspects are geometric deviations and lack of concrete quality. The KPIs are measured with the tools listed under a). The Table 5 gives an overview about application of tools, measurement needs and expected solutions in order to avoid the problem beforehand.

1. Foundation	Type of error	relevant norms	relevant KPI's and value	What to measure?	How to measure?	Who is a problem owner? Whome to inform?	What is current practice?	How to address the problem?	How to prevent error in future?
	geometric deviations (from planning) in foundation	DIN 18202:2013-04 Toleranzen im Hochbau,	could be heat transfer (air leakage, U-value)	geometry, altitude, geoposition	e.g. 3D laser scanner, compare with virtual model, AR, BIM overlay	manufacturer on site: if applicable: schedule problem: inform project coordinator	rebuilt or make corrections, if possible	project coordinator has to clarify with manufacturer and client	Identify cause of error to eliminate it, documentation – input to future guideline, check before delivery of panels
	Relevant detail lack of concrete strength in foundation	DIN EN 206-1 und DIN 1045-2	could be heat transfer (humidity, U-value)	concrete strength	rebound hammer	see above	see above	see above	see above
	crack in foundation	DIN EN 206-1 und DIN 1045-2	could be heat transfer (humidity, U-value)	crack width and depth	e.g. 3D laser scanner, compare with virtual model, AR, BIM overlay	see above	see above	see above	see above

Table 5: Foundation - application of tools, measurement needs and expected solutions



2. Joint ground floor foundation

The critical quality aspects are geometric deviations and lack of concrete quality. The KPIs are measured with the tools listed under a). The Table 6 gives an overview about application of tools, measurement needs and expected solutions in order to avoid the problem beforehand.

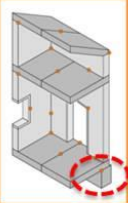
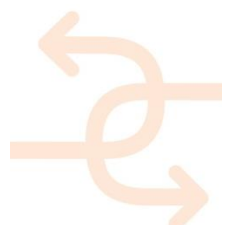
2. Joint ground floor/ foundation	Type of error	relevant norms	relevant KPI's and value	What to measure?	How to measure?	Who is a problem owner? Whome to inform?	What is current practice?	How to address the problem?	How to prevent error in future?
 Relevant detail	geometric deviations (from planning) in foundation or ground floor element	DIN 18202:2013-04 <u>Toleranzen im Hochbau</u> ,	could be heat transfer (air leakage, U-value)	geometry, altitude, geoposition	e.g. 3D laser scanner, compare with virtual model, AR, BIM overlay	manufacturer on site: if applicable: schedule problem: inform project coordinator	rebuilt or make corrections, if possible	project coordinator has to clarify with manufacturer and client	Identify cause of error to eliminate it, documentation – input to future guideline, check before delivery of panels
	lack of concrete strength in foundation or floor element	DIN EN 206-1 und DIN 1045-2	could be heat transfer (humidity, U-value)	concrete strength	rebound hammer	see above	see above	see above	see above
	crack in foundation or floor element	DIN EN 206-1 und DIN 1045-2	could be heat transfer (humidity, U-value)	crack width and depth	e.g. 3D laser scanner, compare with virtual model, AR, BIM overlay	see above	see above	see above	see above

Table 6: Joint ground floor foundation - application of tools, measurement needs and expected solutions



3. Accuracy of ground floor element

The critical quality aspects are geometric deviations and lack of concrete quality. The KPIs are measured with the tools listed under a) and c). The Table 7 gives an overview about application of tools, measurement needs and expected solutions in order to avoid the problem beforehand.

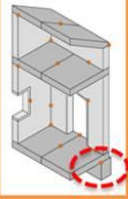
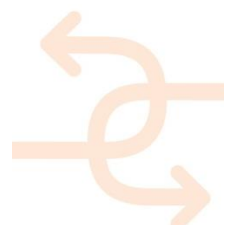
3. Accuracy of ground floor element	Type of error	relevant norms	relevant KPI's and value	What to measure?	How to measure?	Who is a problem owner? Whome to inform?	What is current practice?	How to address the problem?	How to prevent error in future?
 Relevant detail	geometric deviations (from planning) in ground floor element	DIN 18202:2013-04 <u>Toleranzen im Hochbau</u> ,	could be heat transfer (air leakage, U-value)	geometry	e.g. 3D laser scanner, compare with virtual model, sound brush, AR BIM overlay	manufacturer in factory: if applicable: schedule problem: inform project coordinator	rebuilt or make corrections, if possible	project coordinator has to clarify with manufacturer and client	Identify cause of error to eliminate it, documentation – input to future guideline, check before delivery of elements
	lack of strength in ground floor element	DIN 1045-1 <u>Verformungen</u> , DIN EN 1992-1-1:2011-01	could be heat transfer (humidity, U-value)	bending,	e.g. 3D laser scanner, see above	see above	see above	see above	see above
	wrong materials in ground floor element	-	could be heat transfer (humidity, U-value, air leakage)	accoustic performance, thermal performance	e.g. 3D laser scanner (see above) sound brush, thermal camera	see above	see above	see above	see above

Table 7: Accuracy of ground floor element - application of tools, measurement needs and expected solutions



4. Joints ground floor element

The critical quality aspects are geometric deviations and lack of structural quality. The KPIs are measured with the tools listed under a) and c). The Table 8 gives an overview about application of tools, measurement needs and expected solutions in order to avoid the problem beforehand.

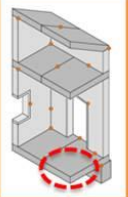
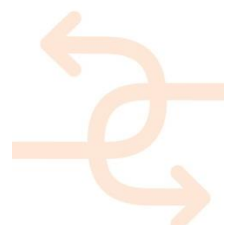
4. joints ground floor elements	Type of error	relevant norms	relevant KPI's and value	What to measure?	How to measure?	Who is a problem owner? Whome to inform?	What is current practice?	How to address the problem?	How to prevent error in future?
 Relevant detail	geometric deviations (from planning) in ground floor element	DIN 18202:2013-04 <u>Toleranzen im Hochbau</u> ,	could be heat transfer (air leakage, U-value)	geometry	e.g. 3D laser scanner, compare with virtual model, sound brush, AR BIM overlay	manufacturer in factory: if applicable: schedule problem: inform project coordinator	rebuilt or make corrections, if possible	project coordinator has to clarify with manufacturer and client	Identify cause of error to eliminate it, documentation – input to future guideline, check before delivery of elements
	lack of strength in ground floor element	DIN 1045-1 <u>Verformungen</u> , DIN EN 1992-1-1:2011-01	could be heat transfer (humidity, U-value)	bending,	e.g. 3D laser scanner, see above	see above	see above	see above	see above
	wrong materials in ground floor element	-	could be heat transfer (humidity, U-value, air leakage)	accoustic performance, thermal performance	e.g. 3D laser scanner (see above) sound brush, thermal camera	see above	see above	see above	see above

Table 8: Joints ground floor element - application of tools, measurement needs and expected solutions



5. Joints ground floor/wall

The critical quality aspects are geometric deviations and lack of element quality. The KPIs are measured with the tools listed under a) to h). The Table 9 gives an overview about application of tools, measurement needs and expected solutions in order to avoid the problem beforehand.

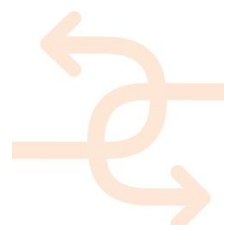
5. Joint ground floor/wall	Type of error	relevant norms	relevant KPI's and value	What to measure?	How to measure?	Who is a problem owner? Whome to inform?	What is current practice?	How to address the problem?	How to prevent error in future?
 Relevant detail (2D, 3D drawings of your project)	Geometric deviations in ground floor or wall element, wrong place or angle	DIN 18202:2013-04 <u>Toleranzen im Hochbau</u>	could be heat transfer, thermal comfort, visual comfort, acoustic, indoor air quality	geoposition, altitude	e.g. 3D laser scanner, compare with virtual model, AR, BIM overlay	assembler, if time schedule is affected, inform project coordinator	make corections, if possible	internally by assembler, or project coordinator has to clarify with assembler, manufacturer and client	identify cause of error to eliminate it, documentation – input to future guideline, check before delivery of elements
	Element damaged (e.g. transport)		see above	sending, surface	see above, visual control	see above	see above	see above	see above

Table 9: Joints ground floor/wall - application of tools, measurement needs and expected solutions



3.5 Method to calculate the selected KPIs based on the measured parameters

As mentioned in previous section, the German DIN 18202 Tolerances in Buildings is a good reference for a methodology development of quality assurance related to geometrical accuracy. The purpose of this DIN is to define basic principles for geometrical tolerances and for checking procedures of these tolerances. This DIN can be applied to all kinds of buildings and their parts such as single components that are produced separately from the site in relation to location and time and that are later integrated into the building itself. The scope of the regular application of this DIN is limited to buildings. The tolerances in this DIN can be applied to all materials such as masonry, concrete, reinforced concrete, steel, wood. Constructions that contain different materials (can) have the same requirements to dimensional accuracy. The idea is to use this DIN as an instrument for the INSITER project as a check methodology and not as a list of thresholds that might be applied. Within INSITER the values can be different; they can be adjusted to different demands, e.g. what is possible and acceptable related to national requirements and basics or different sizes of construction sites.

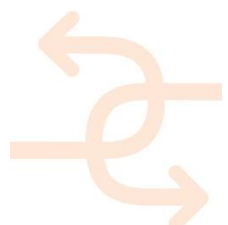
In a drawing of a building the dimensions are defined as theoretical nominal and exact values. In practice a deviation from these values is unpreventable. The description of the deviations and the limitations of the deviations to a maximal acceptable error is in fact the definition of tolerances. The construction of a building is related to a certain intended use or purpose. The definitions of the tolerances should be made with regard to ensure all intended functions of the building. The aim of making the definitions is to ease the assembly on site and to avoid extensive rectification works. At the same time it has to be clarified with what means the compliance with the maximal acceptable tolerances can be achieved and how it can be controlled during the building process. On basis of this, DIN tolerance calculations about fitting can be made.

3.6 Practical steps for self-inspection to measure the relevant parameters, including use of relevant measurement devices

In chapter 3.1 the following list of points of junction to be checked has been developed:

1. Geometrical accuracy of the foundation
2. Joint between floor construction and foundation
3. Geometrical accuracy of the prefab floor slabs
4. Joint between two prefab floor slab elements
5. Joint between floor element and wall element

The analysis and the appropriate way of getting rid of construction errors at building site level contains the overview of applicable German building standards for qualifying geometrical accuracy as a transferable sample for the INSITER tool and a methodology development guideline in order to define the degrees of adjustability and the aspects that have to be analysed, calculated and balanced. In 4.4 more aspects for measuring e.g. U values, sound insulation and other topics are highlighted. Chapter 3 is focusing on geometric accuracy. Other building physic topics will be handled by following chapters.

The following explanation and supporting schemes represent the methodology mentioned above to be applied and the calculation needs.

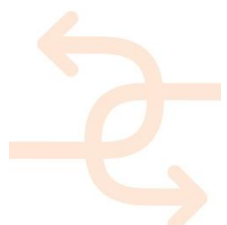

Geometrical accuracy of the foundation and the prefab slabs influencing the required quality of joints

The regular problem at the new building site and even more severe at the retrofitting site is the incorrectness created by adding up tolerances from the existing structure and/or the prefab panels. The objective is to calibrate the prefab element toolkit at any stage of the assembly process checking deviations and tolerances that are always existing against thresholds. The German DIN 18202 is providing a methodology of analysis that is transferred to INSITER needs – reference to current version in German and English and the full text version dated 2005 representing the current content, documents: 1) DIN 18202 Tolerances in Buildings; 2) DIN 18202:2013-04 (D), Toleranzen im Hochbau – Bauwerke (German Language); 3) DIN 18202:2013-04 (E), Tolerances in building constructions: Buildings and 4) DIN 18202:2005-10; Tolerances in building constructions: Buildings (German language).

The acceptable tolerances are influenced by varying parameters. E.g. the gap closure between two prefab elements is more or less sensible dependent on the kind of gap structure and closing allowing the coverage of bigger or smaller tolerances. In that case the thresholds are quite individual and there is an urgent need to calibrate the INSITER tool according to these individual needs related to material application and to the systemic approach of the characteristic points of junction developed by the prefab company and following their own construction detail.

a. Limitations for deviations from nominal sizes according to DIN 18202 methodology

The Figure 7 explains the types of deviation in dimension from minimum to maximum and the created area of tolerated inconsistencies. The developed graphic scheme should be available at a handheld device in order to measure the existing difference to the optimum solution against the threshold and to record the measured deviations for further analysis. There are at least two easy possibilities to record the position and the deviation by GPS related laser measuring, stereo-metric photography or regular -analogue- measuring and storing the data to the INSITER cloud via the tool data connection. The construction worker will receive a simple feedback showing green, yellow or red light representing the quality of the result. The qualification of the measurement is combined with action: red means not acceptable, adjustments have to be done, yellow means careful monitoring is urgently needed in order not to mismatch with the threshold, green means just go ahead with mounting.

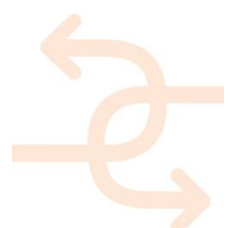

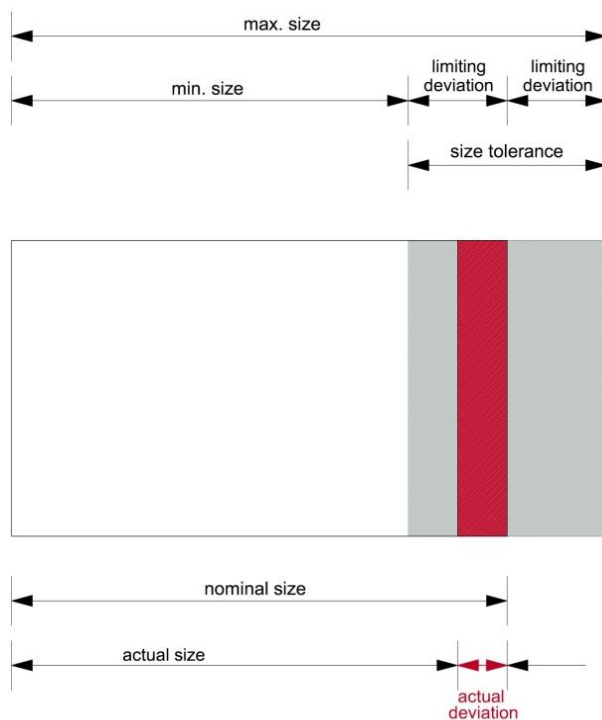
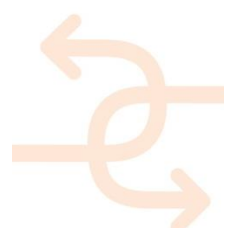

Figure 7: Types of deviations

The limiting deviations thresholds are transferred from the German DIN 18202 methodology. As already mentioned above the assignment of thresholds and the fixation of thresholds in numbers should be done related to the characteristic needs of the characteristics of the construction systems and individual mounting needs. The thresholds listed below are just a sample and have to be adjusted according the above mentioned individual requirements. Nevertheless especially related to the buildings performance the check will be done according to national or regional or local building law that are following the German DIN 18202 methodology principles not precisely the embedded thresholds -see overview Table 10.



limiting deviations

limiting deviations DIN 18202							
	nominal sizes ≤ 1 m	nominal sizes >1 m and ≤ 3 m	nominal sizes >3 m and ≤ 6 m	nominal sizes >6 m and ≤ 15 m	nominal sizes >15 m and ≤ 30 m	nominal sizes >30 m and ≤ ca. 60 m	example
sizes							
plan view floor plan	± 10mm	± 12mm	± 16mm	± 20mm	± 24mm	± 30mm	sizes of building elements
in elevation	± 10mm	± 16mm	± 16mm	± 20mm	± 30mm	± 30mm	heights of building elements
distance between two elements							
plan view floor plan	± 12mm	± 16mm	± 20mm	± 24mm	± 30mm	no rule	distance between two building elements
in elevation	± 16mm	± 20mm	± 20mm	± 30mm	no rule	no rule	clear height
openings for doors / windows							
reveal surface not finished	± 10mm	± 12mm	± 16mm	no rule	no rule	no rule	window dimension in unfinished state
finished reveal surface	± 8mm	± 10mm	± 12mm	no rule	no rule	no rule	window size when completed

Table 10: Limiting deviations according to DIN 18202

The blanks in the columns have to be filled in with the adjustable thresholds by the prefab companies (see Table 11). On behalf of INSITER the prefab partner DRAGADOS will fill in the chart and their individual data set will be used for the guidelines produced in D1.2 due at M 36. Furthermore other companies will be interviewed regarding their specific thresholds.

limiting deviations

limiting deviations INSITER							
	nominal sizes ≤ 1 m	nominal sizes >1 m and ≤ 3 m	nominal sizes >3 m and ≤ 6 m	nominal sizes >6 m and ≤ 15 m	nominal sizes >15 m and ≤ 30 m	nominal sizes >30 m and ≤ ca. 60 m	example
sizes							
plan view floor plan							sizes of building elements
in elevation							heights of building elements
distance between two elements							
plan view floor plan							distance between two building elements
in elevation							clear height
openings for doors / windows							
reveal surface not finished							window dimension in unfinished state
finished reveal surface							window size when completed

Table 11: Limiting deviations INSITER

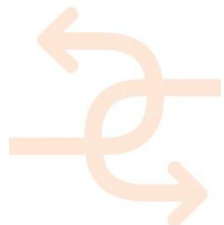

b. Limitations for deviations from angular alignment according to DIN 18202 methodology

Besides measurements related to lengths especially a 3D oriented angular deviation could cause increasing trouble in the follow up of the building process. The mapping of the site conditions have be done first. The concept of working with the existing tolerances and balancing them somehow on the site is created automatically based on the BIM model and the state-of-the-art overlay before mounting. The construction workers have to inspect the correct angle alignment continuously while mounting the elements (Figure 8). The inspection should be recorded in order to create a “built as modelled” data package that will be needed for maintenance issues at the same time.

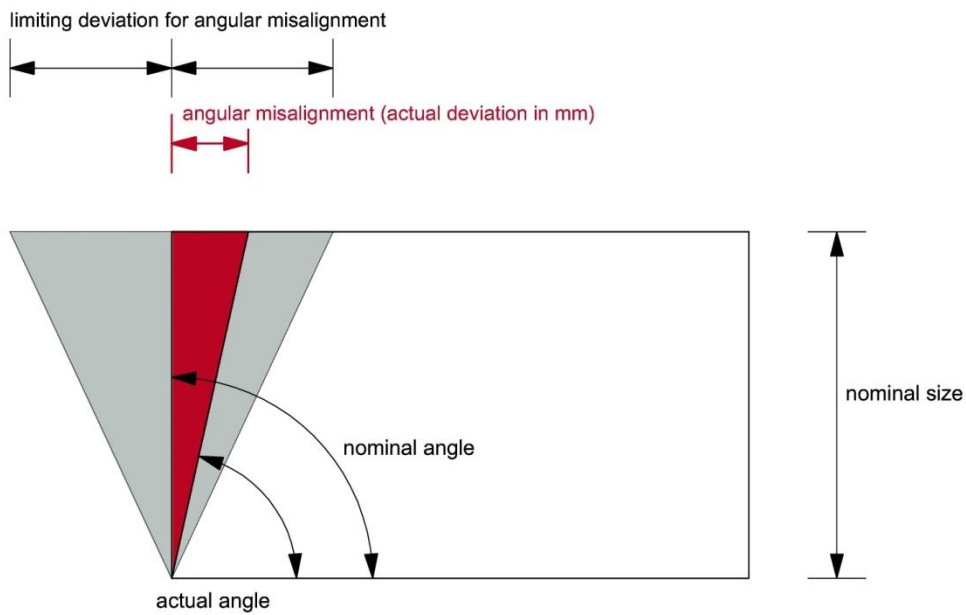
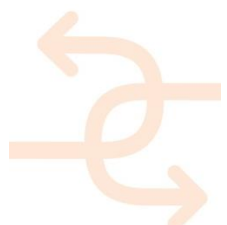

Figure 8: Limiting deviation for angular misalignment

limiting deviations for angular misalignment

limiting deviations for angular misalignment DIN 18202								
	nominal sizes ≤ 0,5 m	nominal sizes >0,5 m and ≤ 1 m	nominal sizes >1 m and ≤ 3 m	nominal sizes >3 m and ≤ 6 m	nominal sizes >6 m and ≤ 15 m	nominal sizes >15 m and ≤ 30 m	nominal sizes >30 m and <60 m	
floor surfaces, ceiling surfaces, wall surfaces surfaces in stage, surfaces of building elements	3 mm	6 mm	8 mm	12 mm	16 mm	20 mm	30 mm	

Table 12: Limiting deviation for angular misalignment DIN 18202



limiting deviations for angular misalignment

limiting deviations for angular misalignment INSITER								
	nominal sizes ≤ 0,5 m	nominal sizes >0,5 m and ≤ 1 m	nominal sizes >1 m and ≤ 3 m	nominal sizes >3 m and ≤ 6 m	nominal sizes >6 m and ≤ 15 m	nominal sizes >15 m and ≤ 30 m	nominal sizes >30 m and ≤ 60 m	
floor surfaces, ceiling surfaces, wall surfaces surfaces in stage, surfaces of building elements								

Table 13: Limiting deviation for angular misalignment INSITER

The blanks in the columns have to be filled in with the adjustable thresholds by the prefab companies. On behalf of INSITER the prefab partner DRAGADOS will fill in the chart and their individual data set will be used for the guidelines produced in D1.2 due at M 36. Furthermore other companies will be interviewed regarding their specific thresholds.

c. Limitations for deviations from flatness according to DIN 18202 methodology

Especially the first level mounting is the most crucial as deviations from flatness cause ongoing and adding up troubles in the mounting process. Building contractors for prefab buildings are often not responsible for the foundation. Therefore they try to define precisely at the contractual level with subcontractors or clients who have to deliver the flatness accuracy to the contractor. These contracts request flatness levels that are out of scope of existing building techniques and not achievable on site. However, often the discussion between the building partners after the realization of the funding is wasting time and energy as the involved partners are accusing each other for bad performance not fulfilling the contractual limits. Nevertheless there is a need for analysing the flatness level before the mounting process starts (Figure 9). INSITER methodology will help to transfer the laser levelling data to the flatness threshold module of the INSITER tool. The reason is twofold: 1. The threshold survey is needed to create action for adjustment, 2. The documentation helps to organize next steps and develop demanded thresholds of dimensional accuracy created by dimensional incorrectness.

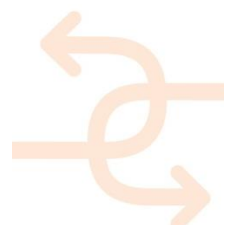

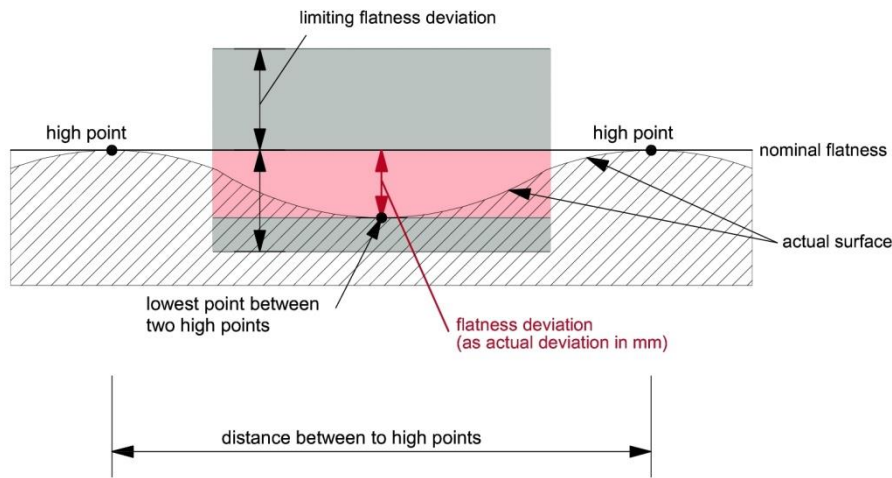

definition limiting flatness deviation

Figure 9: Definition limiting flatness deviation

limiting flatness deviations

limiting flatness deviations DIN 18202						
	distance between two metring points 0,1 m	distance between two metring points 1 m	distance between two metring points 4 m	distance between two metring points 10 m	distance between two metring points 15 m	example
floor surfaces and upsides of slabs						
surfaces not finished	10mm	15mm	20mm	25mm	30mm	floor slabs und slabs not finished
surfaces not finished, without additional flatness equalization	5mm	8mm	12mm	15mm	20mm	floor slabs und slabs partly finished
surface finished, minor objects	5mm	8mm	12mm	15mm	20mm	floor surfaces in minor objects (payload spaces)
surface finished	2mm	4mm	10mm	12mm	15mm	floor surfaces screed or pavement
surface finished, increased requirements	1mm	3mm	9mm	12mm	15mm	floor surfaces screed or pavement
walls and undersides of slabs						
surfaces not finished	5mm	10mm	15mm	25mm	30mm	concrete, wood or masonry building elements in construction
surface finished	3mm	5mm	10mm	20mm	25mm	cladding
surface finished, increased requirements	2mm	3mm	8mm	15mm	20mm	cladding

Table 14: Limiting flatness deviations DIN 18202

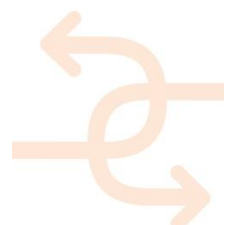

limiting flatness deviations

limiting flatness deviations INSITER						
	distance between two metring points 0,1 m	distance between two metring points 1 m	distance between two metring points 4 m	distance between two metring points 10 m	distance between two metring points 15 m	example
floor surfaces and upsides of slabs						
surfaces not finished						floor slabs und slabs not finished
surfaces not finished, without additional flatness equalization						floor slabs und slabs partly finished
surface finished, minor objects						floor surfaces in minor objctets (payload spaces)
surface finished						floor surfaces screed or pavement
surface finished, increased requirements						floor surfaces screed or pavement
walls and undersides of slabs						
surfaces not finished						concrete, wood or masonry building elements in construction
surface finished						cladding
surface finished, increased requirements						cladding

Table 15: Limiting flatness deviations INSITER

The blanks in the columns have to be filled in with the adjustable thresholds by the prefab companies. On behalf of INSITER the prefab partner DRAGADOS will fill in the chart and their individual data set will be used for the guidelines produced in D1.2 due at M 36. Furthermore other companies will be interviewed regarding their specific thresholds.

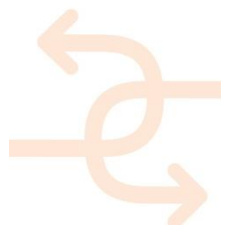

d. Limitations for deviations from alignment according to DIN 18202 methodology (Figure 10)

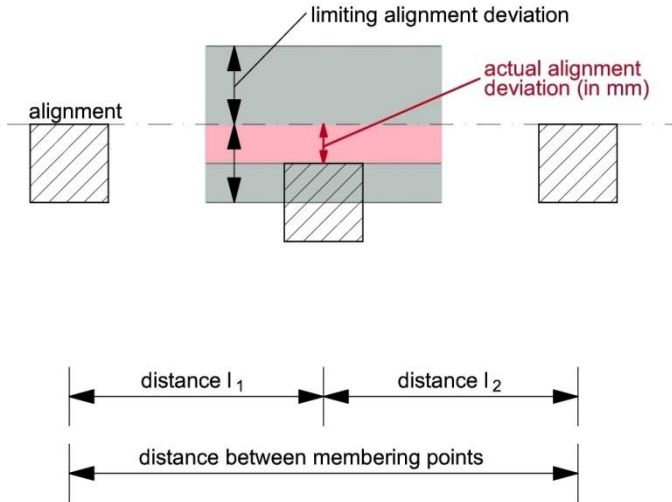

Figure 10: Limiting alignment deviation

limiting alignment deviations

limiting alignment deviations DIN 18202					
	distance of metering point $\leq 3,0$ m	distance of metering point $>3,0$ m $\leq 6,0$ m	distance of metering point $>3,0$ m $\leq 6,0$ m	distance of metering point $>3,0$ m $\leq 6,0$ m	distance of metering point $>3,0$ m $\leq 6,0$ m
alignment deviation of a intermediate support between two end supports	8 mm	12 mm	16 mm	20 mm	30 mm

Table 16: Limiting alignment deviations DIN 18202

limiting deviations for angular misalignment

limiting deviations for angular misalignment INSITER								
	nominal sizes $\leq 0,5$ m	nominal sizes $>0,5$ m and ≤ 1 m	nominal sizes >1 m and ≤ 3 m	nominal sizes >3 m and ≤ 6 m	nominal sizes >6 m and ≤ 15 m	nominal sizes >15 m and ≤ 30 m	nominal sizes >30 m and <60 m	
floor surfaces, ceiling surfaces, wall surfaces surfaces in stage, surfaces of building elements								

Table 17: Limiting deviations for angular misalignment INSITER

The blanks in the columns will be filled in with the adjustable thresholds by the prefab companies, depending on the selected products. Furthermore other companies will be interviewed regarding their specific thresholds.

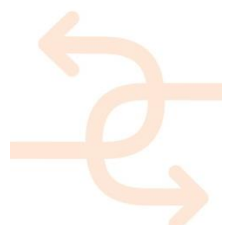

Principles of testing

The testing of a building element should be done as soon as possible. The inspector has to choose a proper measuring method according to the purpose of the testing. In the testing procedure points, lines and planes are examined. Points are tested regarding their distance to a reference point. Lines are tested regarding their starting- and endpoint and regarding the position of the connection of them. Plains are tested regarding their corner points and regarding the connection of the corner points and regarding their flatness. Sizes, angles, flatness and alignment have to be measured separately and the measured values have to be compared with values that are predefined in the Tables 10 – 17. Further details are also provided in this section and explained in Figures 11 – 15.

Testing of sizes in floorplan and elevation

In the floor plan the sizes of length, width, axis-centre distance, and grid-space are measured at the building corners or at the intersection of the axes through the complete length of the building element and compared with the nominal sizes of the drawings (Figure 11). The measurement to test the sizes of a floorplan is made directly on the floor surface and with a distance of approx. 10 cm to the building corners to avoid influences from irregularities in the corner or edge zone of the elements.

In the elevation the sizes should be measured exactly vertical at characteristic spots of the building such as height between floors, height of landings, distances between mounting brackets, slab edges, balustrades, and binding beams. If there are nominal sizes to be checked for execution, the sizes defined in the drawings have to be measured. Measuring points for the clear opening/inside width in the floor plan, e.g. the width between columns have to be measured in a height of 10 cm above the floor and in a second height of 10 cm underneath the ceiling. The measurement has to be made in 10 cm distance from the element corners.

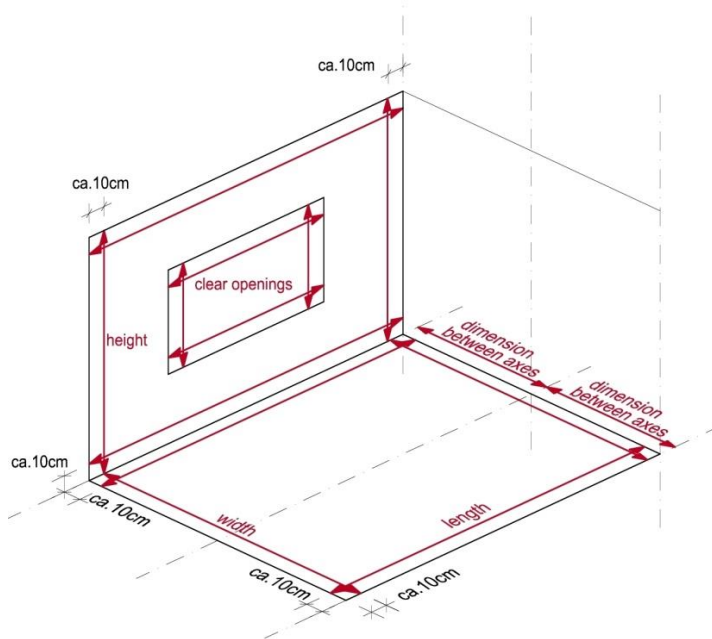
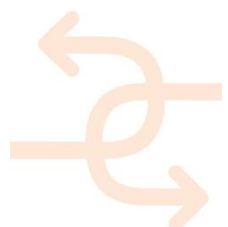

Figure 11: Testing of sizes in floorplan and elevation



Testing of angular misalignment

Measurement of angular misalignment in the floorplan: The first step to define the angular deviations between two vertical building elements (e.g. walls) is to install a reference line (Figure 12). The reference line is a parallel line to the connection of the end points of the tested elements with a distance of 10 cm to it. The nominal angle has to be installed from the reference line of the longer building element. Angular misalignment is then measured by defining the deviation in mm between the reference line and the nominal angle at the shorter element. With this procedure the whole element is regarded, not the middle of an element.

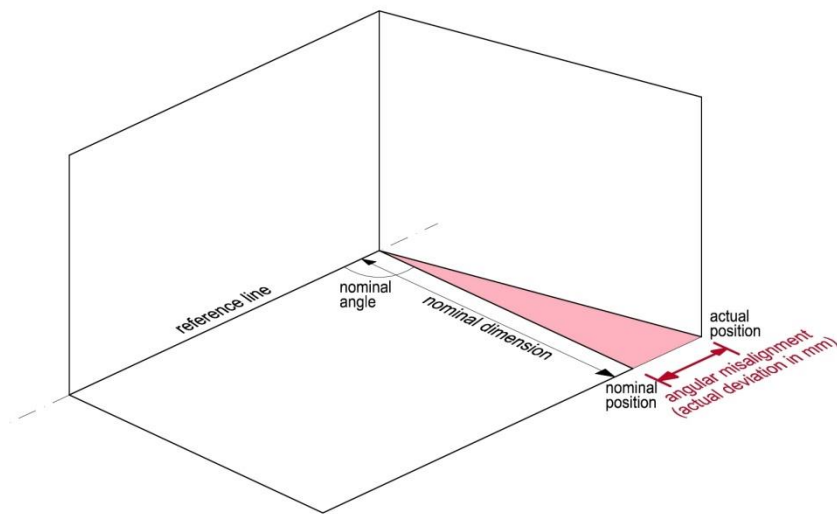
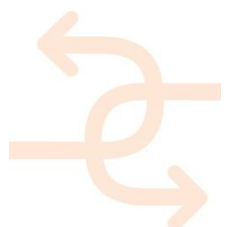

Figure 12: Testing of angular misalignment



Testing of flatness deviations

The testing of flatness deviations (Figure 13) is made independent from the testing of sizes and angular misalignment. Two high metering points are defined and connected to a line (with a straightedge or with planar levelling) the actual deviation is the distance from a low point to the connection line. The measured deviations have to be compared with the predefined tabular values.

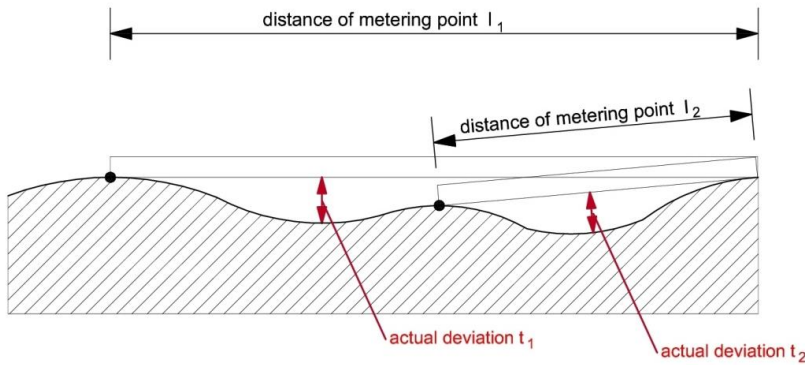

Figure 13: Testing of flatness deviations

Planar levelling

If the flatness will be tested with the application of a planar levelling the plain has to be subdivided into an orthogonal grid of e.g. 0.5 x 0.5 m, 1 m x 1 m or 2 m x 2 m. The flatness is tested in each matrix dot in relation to its both adjacent matrix dots (as described above. The testing is made in both directions of the matrix. The actual values are compared to the predefined tabular values. All tested values have to match the predefined flatness accuracy (Figure 14).

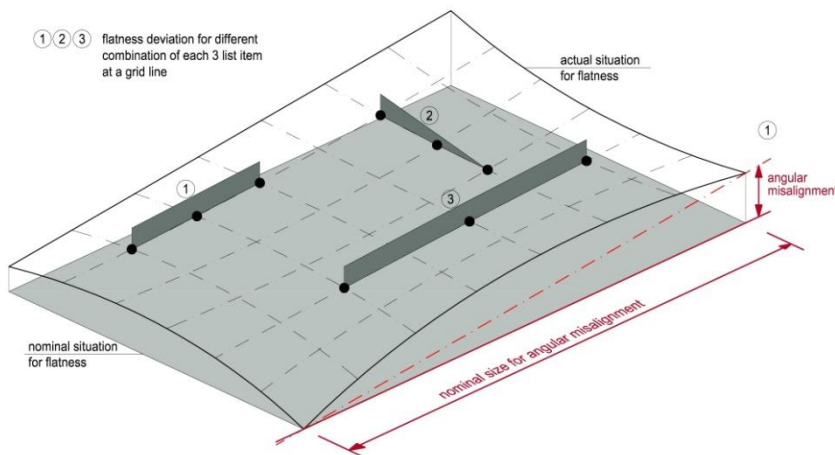
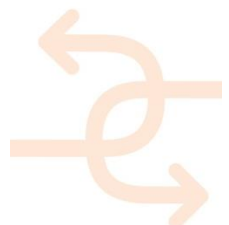

Figure 14: Planar levelling



Testing of misalignment

The position of an intermediate support is tested in relation to the connection line of the end supports of a row of supports. The actual deviation from the alignment, that has to be measured in the axis of a building element, is compared with the predefined tabular values (Figure15).

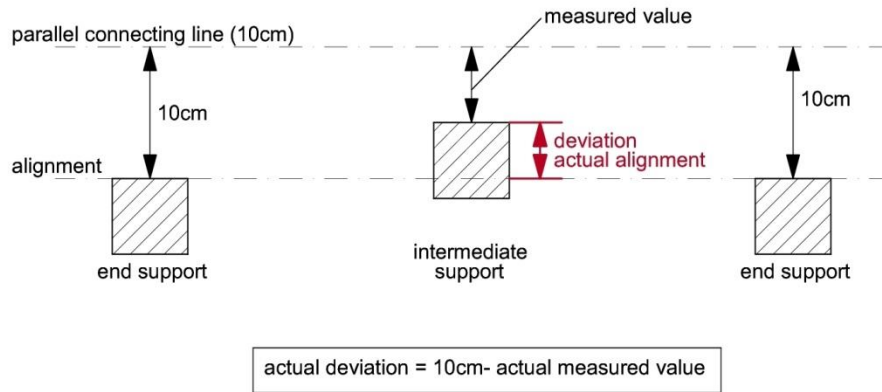
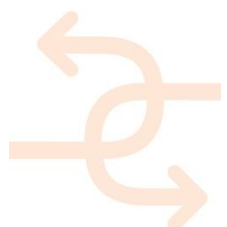

Figure 15: Testing of misalignment



4. Critical EeB component 2: Building envelope –

Exterior walls and built-in elements

4.1 Analysis of prefab façade elements and relevance in workflow and quality assuring methodology development for the façade building components

Mounting prefabricated elements means placing, connecting and anchoring prefabricated elements to or on the foundation and the bearing structure. Mounting in such way that the final results meet the declared demands of the supplier on one hand and the demands of the principal on the other hand. The demands are found in the field of strength, stiffness, fire resistance, sound insulation, thermal insulation, vapour density, windproof, air tightness, rain screen, water repellence, water resistance, burglary proof, displacement and deformation, their appearance and flatness.

The functional requirements of moving parts (windows and doors) in these elements should also be ensured.

We assume that mounting prefabricated façade elements follows the same procedure for new build and refurbishment.

In the case of refurbishment, the existing façade elements will be removed and replaced by a prefabricated façade element. The bearing construction has to be prepared in such way that the new façade element can be placed in the right way (bearing capacity, flat, square and straight and dimensional tolerances within the limits). The preparation of the existing bearing structure is outside the scope of INSITER. But before mounting, the installer controls the bearing construction to assure a good connection (self-instruction).

The degrading of the façade element itself and the material used to assure a good connection to the bearing construction (sealants and anchoring) and creep, shrinkage or thermal movement asks for a re-commissioning procedure in the maintenance phase. The Dutch norm *NEN 2767-2 Condition assessment of building and installation components - Part 2* identifies faults for the façade (outside walls bearing and non-bearing). In INSITER we will focus on those items related to the installation of the façade element and the relevant KPIs.

Within the context and purpose of INSITER, the prefabricated façade elements are distinguished between:

- Lightweight façade elements;
- Heavy weight façade elements.
- Both types can be loadbearing and non-loadbearing.

The most important lightweight prefabricated façade elements are:

- Timber frame façade elements;
- Steel frame façade elements;
- Sandwich façade elements.

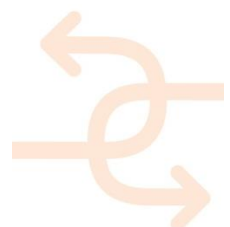

The most important heavy weight prefabricated façade elements:

- Concrete façade elements:
- Brick façade elements.

See Appendix 3 for a detailed description of the light and heavy weight prefabricated façade elements.

The most important functions of the façade are:

- Thermal insulation;
- Sound insulation;
- Protection against rain;
- Protection against wind / airtightness;
- Fire safety;
- Constructive aspects;
- Aesthetic aspects.

The ultimate prefabrication of the façade elements contains a complete façade element (inner cavity wall, insulation and cladding), openings (windows and doors) and integrated installation systems (buildings heating, ventilation and sanitation systems).

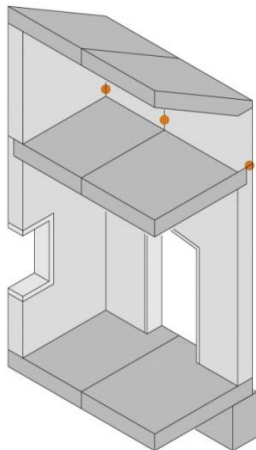
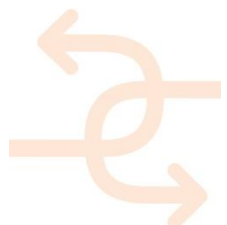

Figure 16: Characteristic points of junctions

For building envelope (exterior walls and built in elements) following characteristic points of junction are of interest (Figure 16):

1. Geometrical accuracy of the bearing construction
2. Geometrical accuracy of the prefab façade elements
3. Joint between two prefab façade elements
4. Joint between façade elements and bearing construction

The joint between floor element and façade element and the joint between façade element and roof are described in the relevant chapters in this document. This is the reason why no repetition will be provided within this chapter.



4.2 Typical assembly process

In this chapter a summary is given of an example of an implementing directive for the assembly process of timber frame façade elements (based on the Dutch implementing directive URL 0802-1001- Implementing directive for mounting of non-bearing timber inner leaves of a cavity wall timber and façade timber frame elements).

The installer of the prefabricated façade elements should have knowledge of all aspects mentioned in this directive to guarantee the quality of the mounting and the safety of the worker.

For the INSITER project we focus on the self-instruction procedures needed for the mounting of the façade elements.

Self-instruction for:

- Check of the bearing construction / foundation;
- Check of the façade element;
- Check of the mounting / anchoring;
- Check of the finishing, sealants;
- Check for the hoisting plan;
- Check for the right placement of the façade element.

We will describe the mounting of timber frame elements as an example for the assembly process and the quality control. Although there might be a difference between the mounting of different types of prefabricated elements and their quality control, the information can be derived from this example.

See Appendix 4 for a detailed description of the mounting of the timber frame elements.

The goal of INSITER is to use the BIM-model and Augmented reality to support the installer to mount the prefabricated façade elements in the right way. On the other hand feedback from the installer is needed to improve the design or manufacturing. In section 2.3 and 2.4 a view is provided on how a) BIM can serve as Quality assurance when mounting prefabricated panels and b)

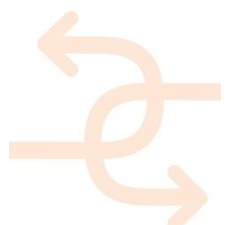

4.3 Summary of most frequently made errors affecting quality and performance of EeB

The error identification is related to the different steps from transportation, entrance control, handling and storage to mounting. Different partners are involved in every step and errors have to be detected as early as possible. The "external" influence on quality performance and assuring issues is relevant for the analysis of the importance and the relevance of the partners' performance. Therefore the list of follow-up steps will be commented in this chapter from another perspective.

Transportation of the façade elements:

- Damage or deformation of the façade element by incorrect loading.
- Damage or deformation of the façade element by insufficient protection.

Reception of the façade elements:

- Wrong façade element is not notified at entrance control.
- Damaged or deformed façade elements are accepted because of insufficient entrance control.

Handling of the façade elements on site:

- Damage or deformation of the façade element by incorrect handling / hoisting.
- Damage or deformation of façade element by incorrect storage / insufficient protection.

Control of bearing construction:

- Dimensional problems with bearing construction (outside the accepted tolerances).
- Construction problems with the bearing construction.
- Bearing construction not flat, square or straight.

Mounting the façade elements:

- Damage or deformation of façade element by wrong way of hoisting or under negative weather conditions.
- Accidents by ignoring safety measurements.
- Anchoring and fixing not according to plan.
- Anchoring and fixing material not according to performance requirements.
- Sealants missing.
- Sealants damaged during mounting.
- Sealants not according to performance requirements.
- Water resistant layers missing.
- Water resistant layers damaged during mounting.
- Water resistant layers not according to performance requirements.
- Foils are not overlapping or the overlapping of foils is not secured.
- Foils are damaged during mounting.
- Foils are not according to performance requirements.

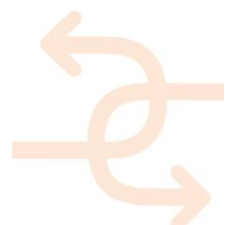

Securing quality after mounting

- Damage by negative weather conditions because the building envelop is not completely closed.

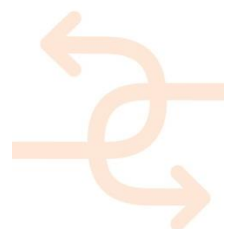

4.4 Relevant INSITER KPIs and to-be-measured parameters for prefab façade elements (including use of measurement devices)

Façade elements are an important part of the building envelope and have a major impact on the realisation of the relevant INSITER KPIs of energy efficiency and the indoor environmental quality.

For energy efficiency, like for all other envelope elements the following generic technical requirements for realising quality assurance are relevant:

- a) Dimensional accuracy / joints / tolerances
- b) Thermal transmittance reduction (U-value)
- c) Structural Stability
- d) Air tightness (thermal relevance)
- e) Water- and vapour-resistance (μ)
- f) Sound insulation (dB)
- g) Fire security (min)
- h) Appropriate material choice and application

For indoor environment quality the following technical requirements for realising quality assurance are relevant

- a) Thermal comfort (reducing overheating)
- b) Airtightness (preventing draught and improve sound insulation)
- c) Acoustics (dB)
- d) Visual comfort by daylight

Typical errors during assembly phases and KPI assignment are shown in the following explanation and supporting schemes.

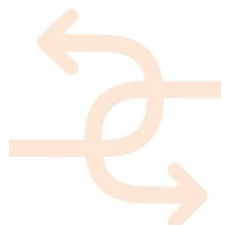

1. Mounting of the prefab façade element to the bearing construction

The critical quality aspects are:

- Geometric deviations of the prefab elements the bearing construction and constructive quality of the bearing construction.
- Problems with anchoring and unwanted connections between elements.
- Problems with sealants and water – and vapour resistant layers.

Table 18 gives an overview about application of tools, measurement needs and expected solutions in order to avoid the problem beforehand.

Connection façade element to bearing construction	Type of error	Relevant norms	Relevant KPI's and values	What to measure?	How to measure?	Who is problem owner? Who to inform?	What is current practice?	How to address the problem?	How to prevent error in future?
	Dimensional incorrectness of bearing construction	DIN 18202: 2013-04 Toleranzen im Hochbau	Heat transfer (air tightness, u-value) Indoor environment (thermal, acoustics)	Geometry	3D laser scanner compared with virtual model, AR BIM overlay	Assembler of bearing construction (new build) or wrong scan of existing situation.	Corrective adjustments or new delivery of facade elements to fit in the real situation	Clarify with problem owners by project coordinator	Identify cause of error and take corrective steps in earlier stages of
	Dimensional incorrectness of prefab façade element	DIN 18202: 2013-04 Toleranzen im Hochbau	Heat transfer (air tightness, u-value) Indoor environment (thermal, acoustics)	Geometry	3D laser scanner compared with virtual model, AR BIM overlay	Supplier of facade element. Inform project coordinator	Corrective adjustments or new delivery	Clarify with problem owners by project coordinator	Feedback to supplier
	Lack of strenght of bearing construction	Eurocodes	Heat transfer (air tightness, u-value) Indoor environment (thermal, acoustics)	Strength of material and construction	Depending on material. For concrete e.g. rebound hammer	Supplier of construction (new build) or wrong scan of existing situation. Inform project coordinator	Corrective adjustments (strengthen construction)	Clarify with problem owners by project coordinator	Identify cause of error and take corrective steps in earlier stages of building proces
	Wrong anchoring of facade element	Eurocodes	Heat transfer (air tightness, u-value) Indoor environment (thermal, acoustics)		Visual check of right material, number and position	Assembly team. Inform Project coordinator in case of problems	Corrective adjustments	Clarify with assembly team	Identify cause of error and take corrective steps in earlier stages of building proces
	Unwanted connection between elements	ISO 10140-7	Indoor environment (acoustics)	Impact sound insulation	Tapping machine	Assembly team. Inform Project coordinator in case of problems	Remove unwanted connections between elements	Clarify with assembly team	Identify and control places where unwanted connection are between elements
	Problems with sealants between facade element and bearing construction	1. Blower door test EN 13829 2. Airborn sound insulation EN-ISO 16283-3:2016 3. Heat transfer EN-13187	Heat transfer (air tightness, u-value) Indoor environment (thermal, acoustics)	1. Air tightness 2. Airborn sound insulation 3. Heat transfer	1. Ultra sound or when building envelop is closed blower door test 2. Sound Brush 3. IR Camera	Assembly team. Inform Project coordinator in case of problems	Corrective actions as early as possible	Clarify with assembly team	Identify and control places where most problems with sealants occur
	Problems with water and vapour resistance layers		Indoor environment (humidity)	Humidity	3D laser scanner and visual check	Assembly team. Inform Project coordinator in case of problems	Corrective actions as early as possible	Clarify with assembly team	Identify and control situation where most problems with water and vapour resistance layer occur

Table 18: Overview of application of tools, measurement needs and expected solutions in order to avoid the problem beforehand



2. Mounting of the prefab façade element to another prefab façade element

The critical quality aspects are:

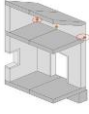
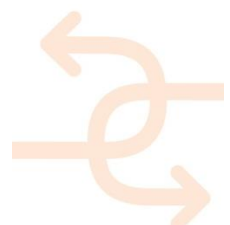
- Geometric deviations of the prefab elements.
- Problems with anchoring and unwanted connections between elements.
- Problems with sealants and water- and vapour resistant layers.

Table 19 gives an overview about application of tools, measurement needs and expected solutions in order to avoid the problem beforehand.

Connection façade elements to each other	Type of error	Relevant norms	Relevant KPI's and values	What to measure?	How to measure?	Who is problem owner? Who to inform?	What is current practice?	How to address the problem?	How to prevent error in future?
	Dimensional incorrectness of prefab façade element	DIN 18202: 2013-04 Toleranzen im Hochbau	Heat transfer (air tightness, u-value) Indoor environment (thermal, acoustics)	Geometry	3D laser scanner compared with virtual model, AR BIM overlay	Supplier of façade element. Inform project coordinator	Corrective adjustments or new delivery	Clarify with problem owners by project coordinator	Feedback to supplier
	Wrong anchoring of façade element to each other	Eurocodes	Heat transfer (air tightness, u-value) Indoor environment (thermal, acoustics)		Visual check of right material, number and position	Assembly team. Inform Project coordinator in case of problems	Corrective adjustments	Clarify with assembly team	Identify cause of error and take corrective steps in earlier stages of building process
	Unwanted connection between elements	ISO 10140-7	Indoor environment (acoustics)	Impact sound insulation	Tapping machine	Assembly team. Inform Project coordinator in case of problems	Remove unwanted connections between elements	Clarify with assembly team	Identify and control places where unwanted connection are between elements
	Problems with sealants between façade elements	1. Blower door test EN 13829 2. Airborn sound insulation EN-ISO 16283-3 :2016 3. Heat transfer EN-13187	Heat transfer (air tightness, u-value) Indoor environment (thermal, acoustics)	1. Air tightness 2. Airborn sound insulation 3. Heat transfer	1. Ultra sound or when building envelop is closed blower door test 2. Sound Brush 3. IR Camera	Assembly team. Inform Project coordinator in case of problems	Corrective actions as early as possible	Clarify with assembly team	Identify and control places where most problems with sealants occur
	Problems with water and vapour resistance layers		Indoor environment (humidity)	Humidity	3D laser scanner and visual check	Assembly team. Inform Project coordinator in case of problems	Corrective actions as early as possible	Clarify with assembly team	Identify and control situation where most problems with water and vapour resistance layer occur

Table 19: application of tools, measurement needs and expected solutions in order to avoid the problem beforehand



4.5 Measuring relevant parameters at different stages

The relevant parameters are to be measured at three different stages:

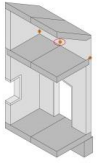
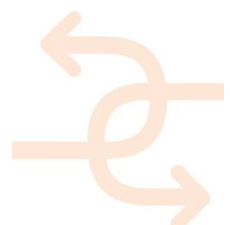
Stage 1: Correctness of the placement of the façade element

Before the mounting of the façade element the dimensional correctness of the element in relation with the bearing construction should be tested (**Geometric discrepancy** by using 3D laser scan).

Just after the mounting of the prefabricated elements the following **indications** for the KPIs can be obtained for right placement:

- Indication ok/ not ok for the airtightness by using ultra sound device;
- Indication ok/not ok for the heat transfer by using a thermal camera and a heat source;
- Indication ok/not ok for the airborne sound insulation using about the sound brush.

The measurements should take place as soon as possible after the mounting of elements, to be able to take corrective measurements as early as possible and prevent additional failure costs as much as possible.

The indication ok/not ok depends on the demanded quality level for the building. Note that the ok/not ok threshold is not the same threshold as the formulated in the program of demands for the building.

Stage 2: Correctness of the whole building envelope

After the whole building envelope is closed the following measurements for the KPIs should take place:

- Measurement of the airtightness by using a blower door (n50-value / qv10 for the Netherlands)
- Measurement of the airborne sound insulation of the façade (GA;k), airborne sound insulation between buildings (Dn,T,A,k) and contact sound insulation between buildings (Ln,T,A)
- Measurement of the heat transfer by using a thermal camera. Please note the specific condition when you can make a good thermal image of the building envelop.
- Measurement of the humidity by using a 3D laser scanner to detect moisture and water problems.

Stage 3: Correctness of the façade during in-use phase

The degrading of the façade element itself and the material used to assure a good connection to the bearing construction (sealants and anchoring) and creep, shrinkage or thermal movement asks for a re-commissioning procedure in the maintenance phase. The Dutch norm *NEN 2767-2 Condition assessment of building and installation components - Part 2* identifies faults for the façade (outside walls bearing and non-bearing).

In INSITER we will focus on those items related to the installation of the façade element and the relevant KPIs. It is about the functional and not the esthetical aspects.

Re-commission gives valuable input to the BIM-system and the quality improvement. Lessons learned from the dysfunction of the façade elements help us to improve the design, fabrication and mounting of the elements. The feedback loop to earlier stages in the building process is needed.

A re-commissioning procedure should be made for the KPIs mentioned in INSITER.

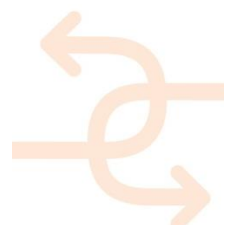

In the Table 20, main type of errors is summarized with respect to the airtightness. This can be done for all measurement aspects of the KPIs. The quantification of the KPIs depends on the demands for the building with the demands of the national building code as a minimum.

KPI	Measurement Aspects	Type of error	Instrument	Action
Heat Transfer	Airtightness	Air leakage connection façade element to construction or to each other	Ultrasound or blower door test. Thermal camera.	Evaluation of the reason of the fault. Replacement or improvement of sealants (when possible) and/or anchoring of the element.
		Air leakage in façade element itself. (e.g. in composite constructions like time frame elements)	Ultrasound or blower door. Thermal camera.	Evaluation of the reason of the fault and repair (when possible) the airtight layers.
		Air leakage connection door and window frames to façade element	Ultrasound or blower door test. Visual inspection of rabbet sealants. Thermal camera.	Evaluation of the reason of the fault. Replacement or improvement of sealants (when possible)
		Air leakage between window frame and glass	Ultrasound or blower door test. Visual inspection e.g. smoke. Thermal camera.	Evaluation of the reason of the fault. Replacement or improvement of kit / sealant.
		Air leakage because of not right closing of door and window frames	Visual (or as a result from the ultrasound / blower door test) Thermal camera.	Adjustment of hinges and locks of door and window frames

Table 20: Main type of errors with respect to the airtightness

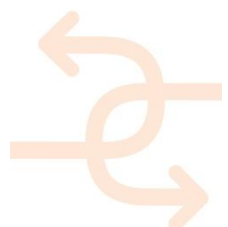

The following self-inspection actions should be performed by the construction worker (responsible for assembly):

- Preparation:
 - We assume that the prefab façade elements passed the quality control of the supplier. The elements have to be checked on failures caused by transport and storage on site before the mounting.
 - Damages (visual check)
 - Flatness, square and right angle in accordance with DIN18202 and/or NEN 3682 (laser scanning)
 - Functionally of the windows and doors (testing if the doors and windows can be opened and closed)
- Pre-mounting and mounting:
 - When the mounting is started, the façade element has to be checked on: Right element on the right place in the building (visual, right RFID, and in combination with the BIM-model)
 - During the mounting of the façade element, the following self-inspection should take place: Right connection and mounting/ anchoring of the elements to another, on the foundation or to the bearing structure (visual and in combination with the BIM-model)
- Finishing:
 - Finishing, sealants and provisions for rain screen, water repellence, water resistance, windproof, and air tightness vapour density, thermal insulation, fire resistance and sound insulation, thermal insulation.
 - Is it present (visual and in combination with the BIM-model)
 - Is it the right material (visual and in combination with BIM-model)
 - Does it work (performance check)
 - Sound-insulation of the connections (SoundBrush)
 - Thermal insulation of the connections (Infrared)
 - Airtightness (Ultrasound)
 - Moisture resistance and overlapping foils at connections and crossings (visual and in combination with BIM-model)
 - Right position of the intra-wall installation facilities like ducts, cables (visual and in combination with BIM-model)
 - Is all the work done

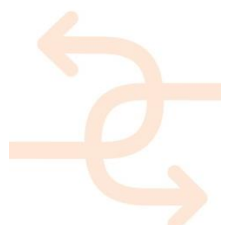

5. Critical EeB component 3: Building Envelope – glass façades (curtain walls)

5.1 Analysis of glazed curtain walls and relevance in workflow

In the context of prefab elements, façades and curtain walls play a fundamental role in the energy performance of the envelope and in the level of quality of the building as a whole: these systems are “high-tech” building components and have to simultaneously provide a different number of performances while respecting constraints in terms of cost, manufacturability, standard compliance and aesthetic appearance. This consideration is particularly significant in the case of glass façades, since large transparent surfaces constitute a potential weak point of the envelope and have an impact on energy performance, acoustics, functionality, indoor air quality. Although curtain wall systems may incorporate a variety of materials, this section focuses on the type that is so ubiquitous, it has effectively become synonymous with the words “curtain wall”: the glazed curtain wall system.

The installation and inspection procedures influence across the entire production process of curtain walls, from design phase to on-site construction and maintenance: actually, the appropriate requirements should be already outlined during the design stage as project requirements and then implemented by all operators/stakeholders involved in the building process with the objective of maintaining, as effectively as possible, the performance level as obtained in the laboratory and certified by the manufacturer. From a complementary perspective, the problems of installation and inspection (during commissioning, maintenance and assessment phases) cannot be separated from those associated with a correct design approach that can advance to take account of some critical issues on site: in this context, during the last few years the design of curtain walls has been developing a specialized sector, i.e. façade engineering, that follow process from curtain wall concept design to commissioning and regular inspections during operation. The purpose of this section is to provide a preliminary guidance for the analysis and inspection of high performance assemblies, and therefore does not concern the selection of the performance characteristics of the façade. This section relies on many other industry standards and is intended to provide both a guideline where the main issues of installing different types of glazed curtain walls are outlined and a basis to develop a *Best Practice* manual within the INSITER project.

The main assumption in INSITER, as already indicated, is that the prefabricated modules are perfectly realized as in the factory and on site a preliminary check is performed when the modules are delivered, just to verify that no problems have occurred during transport. This verification can be performed by visual inspection, NDT methods, and review of QR codes that identify on each façade module. For glass facades, the main issue is to check the integrity of the glass components and the condition of seals and gaskets.

Within the construction workflow (both for industrial, non-residential and residential facilities), the installation of façades occurs when the structure is already completed. The first step on-site is to assess that the dimensional tolerances of the building structure are actually compatible with the dimensions of the façade modules.

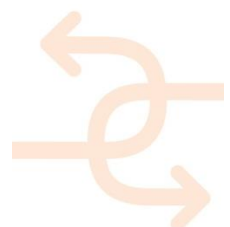

Sometimes, in fact, building structures can be realized in-situ, with dimensional tolerances significantly higher than those provided in the prefabricated components (differences of the order of magnitude of 10). In this regard, the verification of geometric accuracy can be achieved:

- Through a comparison of the BIM model (made during design phase) and the actual consistency of the structure by laser scanner measures;
- Through the verification of the main and secondary alignments where the façade will be installed, by using laser levelling devices.

The purpose is to carry out an immediate quality check, preparatory to installation.

5.1.1 Performance and quality requirements for glazed curtain wall assemblies

Glazed curtain walls are a product with high functional and constructional complexity which includes interfacing of different components that in some cases (such as in the stick systems) are assembled only during installation. Often, when installed, there has been a significant worsening of the curtain wall performance than expected in the design stage and also as measured during laboratory tests.

Generally the curtain walls should satisfy a complex of technological requirements that are intended to be applied to the entire façade system (frame, glass panes, sub-structure, sealing). In addition, the inspection procedures should ensure the compliance with the following main technological requirements, for which performance levels have already been identified within the design development:

- Mechanical resistance (permanent loads, live loads, wind load, impact resistance, horizontal loads), especially in terms of structural adequacy (transfer all loads back to building structure);
- Air tightness and air permeability (vapour);
- Energy efficiency: thermal transmittance and radiation properties (only for glazing units);
- Sound transmission;
- Durability and maintainability.

The performances of a curtain wall depend essentially on the physical and functional interfaces of components and products with performance characteristics different from each other. The interface/connection involves:

- Geometric interface: intended as the definition and respect of the dimensional tolerances related to curtain wall production/installation and the construction tolerances of building structures.
- Mechanical interface: related to the mechanical and deformation characteristics, respectively, of the facades and the support to which it is connected.
- Chemical-physical interface: linked to those chemical-physical characteristics which do not involve mechanical aspects. For example, the coupling of metal materials that are galvanically compatible.

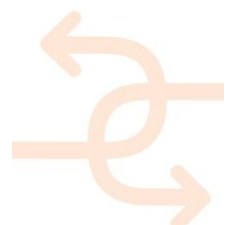

The role of connecting those different components is played by joints and sealing, which can be addressed as the weak points of the assembly since they separate elements different in material, performance. Connections, in on-site installation of curtain walls, cover a number of tasks that can be functionally summarized:

- To ensure the absorption of mutual movements due to thermal, hygrometric and structural actions between adjacent components;
- To allow the required arrangement between construction and façade structure;
- To ensure a satisfactory continuity, even from the aesthetic point of view, between materials and components that are actually separated;
- To prevent, or control, the penetration of water, air flow, heat and noise.
- All these performance requirements apply whether the curtain walls are field-constructed (i.e., stick-built), partially prefabricated, or fully prefabricated in a factory (i.e., modular or unitized systems). Various problems have been observed on meeting these performance requirements with all types of curtain wall systems and during the fabrication, installation, and building occupation stages.

5.2 Overview of systems and typical assembly process

Curtain wall systems range from manufacturer's standard catalogue systems to specialized custom walls. As per European legislation, the harmonised product standard for curtain walling is EN 13830:2015, which applies also to curtain wall with structural glazing and incorporates the Construction Products Regulation (EU) N° 305/2011 (CPR) for the CE marking. This standard defines the curtain wall as an external enclosure, usually aluminium or timber or PVC-framed wall, containing in-fills of glass, metal panels, or thin stone.

In terms of prefabrication, curtain walling is not a product which can be completed in all respects within a manufacturing area, but is a series of components and/or prefabricated units which only become a finished product when assembled together on site. According to the different types of façade systems, variations in assembly process can be recognized and related emerging issues can be identified. In addition, the installer must have a specific knowledge and training to perform the installation. Anyway, the typical workflow for the curtain-wall involves the following steps (as summarized in Guideline UX60 from UNCSAAL- Italy for the Installation of curtain walls):

- Geometric survey, in terms of geometric tolerances with the building structures;
- Check of the on-site condition and acceptance (storage and handling);
- Facade installation arrangement, from the floors and the axis of the building, before the laying of the anchoring;
- Check of the anchorage and connection provision of the facade structure;
- Installation and check of the facade panels/modules;
- Fixing and check of the finishing, joint covers;
- Close up and inspection of the sealing, gaskets (connections);
- Quality control after installation;
- Errors and pathologies that occur during service life.

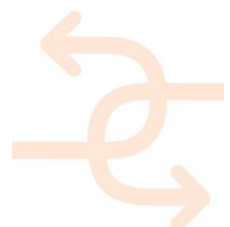

5.2.1 Main possible failures related to different type of assembly

For the purpose of this deliverable and in accordance with EN 13119 (Curtain walling, Terminology) and U.S. whole Building Design Guide⁴, different types of glazed walls can be classified into the following general categories:

1. Stick system: The curtain wall frame (mullions) and glass (or opaque) panels are installed and connected together piece by piece.
2. Unitised (or modular) system: The curtain wall is composed of large units that are assembled and glazed in the factory, shipped to the site and erected on the building.
3. Structural sealant glazing: The glass is supported on all edges by metal mullions, and retention to the metal mullions is accomplished with structural silicone bond-joint, rather than with traditional metal retainers and exterior metal trim.
4. Point-fixed façade: point-loaded structural glazing systems eliminate visible metal framework by incorporating tension cables, trusses, glass mullions, or other custom support structures behind the glass panels.

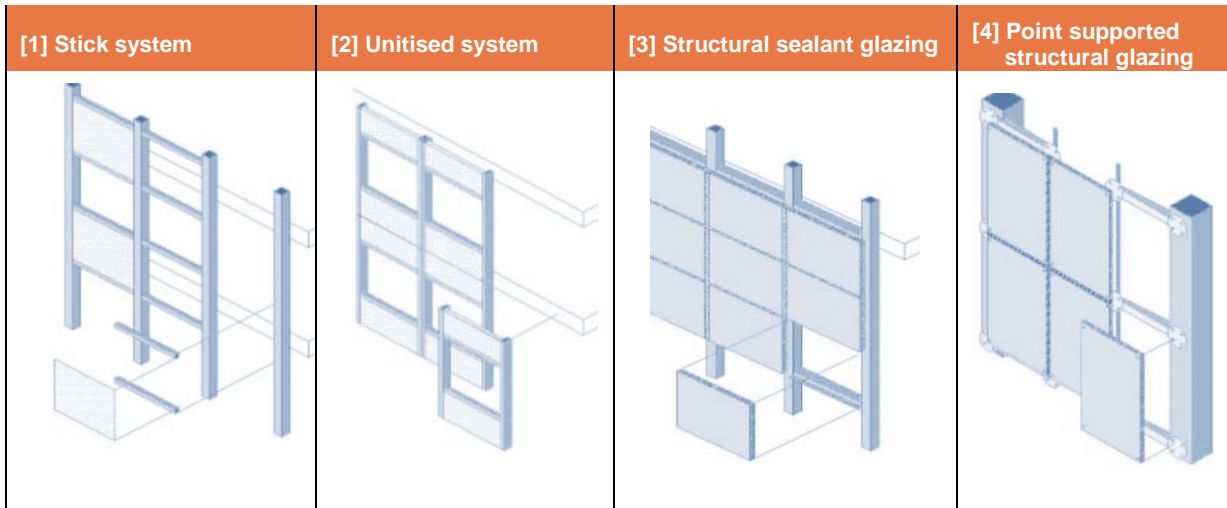
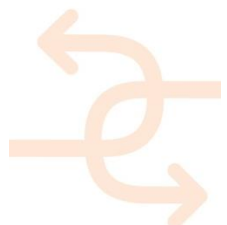

Figure 17: Different types of glazed walls. Image Courtesy of CWCT (University of Bath)

In the Appendix 5, the above listed systems (Figure 17) are described briefly, highlighting for each type: the level of prefabrication, the problems of installation on the construction site, the advantages / disadvantages in terms of energy efficiency and building quality. These pieces of information have been collected by technical documents, interviews with different stakeholders involved in the design and construction process, such as façade engineers, manufacturers and installers.

⁴ Vigenor, Nik and Brown, Mark A. - Simpson Gumpertz & Heger Inc. Revised by the Chairs of the Building Enclosure Councils with assistance from Richard Keleher, AIA, CSI, LEED AP and Rob Kistler, The Facade Group, LLC.



5.3 Most frequently made errors affecting quality and performance of EeB

This sub-chapter discusses failures and other problems encountered during investigations of curtain walls, with the primary focus on glass and aluminium systems. Like all building elements, glazed curtain walls have their weak points. Knowing what to look for, how to extend the service life of a curtain wall system, and when it is time to retain a consultant are critical to avoiding costly and disruptive failures.

Although issues vary with frame material, construction method, and glazing type, there are some common concerns that design professionals look for when evaluating the condition of a curtain wall system. The most common types of failures associated with these systems and that can occur on site, include:

1. Geometric survey, in terms of geometric tolerances with the building structures
 - Incorrect levelling of the structures (deflection).
 - Realization of elements out of plumb or with deviations in the background structure (structure is not flat, square or straight).
2. Check of the on-site condition and acceptance (storage and handling)
 - Incorrect façade element is not identified when delivered (lack of quality control).
 - Damage or deformation of the façade module by incorrect handling / storage.
3. Facade installation arrangement, from the floors and the axis of the building, before the laying of the anchoring
 - Unpredicted deflection or deformation.
 - Damage or deformation of the façade arrangement by incorrect tracking of the reference lines.
 - Poor supervision and workmanship.
4. Check of the anchorage and connection provision of the facade structure
 - Anchoring and fixing not according to plan.
 - Anchoring and fixing material not according to performance requirements.
5. Installation and check of the facade panels/modules
 - Glass pane damage.
 - Streaked glazing.
6. Fixing and check of the finishing, joint covers
 - Water resistant layers missing.
 - Water resistant layers damaged during mounting.
7. Close up and inspection of the sealing, gaskets (connections)
 - Loose gaskets or seals.
 - Gaskets disengaged from glazing.
 - Sealants/gaskets damaged during mounting.
 - Sealants/gaskets not according to performance requirements.
8. Quality control after installation
 - Damage by negative weather conditions because the building envelope is not completely closed.
 - Incorrect cleaning of the facades, especially on connections and sealings.

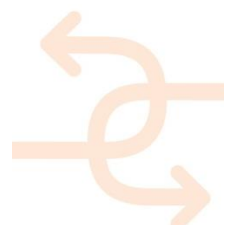

9. Errors and pathologies that occur during service life

Entire wall systems:

- Sign of distress and deterioration;
- Bulging, bowing, separation, delamination, rotation, displacement of panels;
- Marks of water, staining and rust;
- Damaged and missing parts, corrosion, loosening or other defects;
- Moisture appears around or behind the curtain wall.

Glass modules pathologies:

- NiS inclusions;
- Thermal stress;
- Corrosion (of the glass cladding corrosion, corrosion of water flow, chemical etching, dry-wet cycle);
- Condensation;
- Glass breakage.

Metal components pathologies:

- Corrosion of the metal elements;
- Incompatibility with other materials in the facade system or "boundary and interface materials";
- Thermal break problems;
- Defects in fixing system.

Opening and ventilation systems:

- Incorrect use of the structure from the users;
- Accidental impact;
- Degradation of materials and motorized components;
- Wear-out mechanisms;
- Vibration of the façade system due to wind loads or seismic loads;
- Blocking of the outflow channels.

There "lessons learned" are outlined with the intention of defining the main weak points to be investigated during inspection procedures, so that future failures of this nature may be recognized and eventually prevented in order to improve energy efficiency and building envelope quality. The following paragraphs describe more in detail the main pathologies with the related effects on energy efficiency and quality performance.

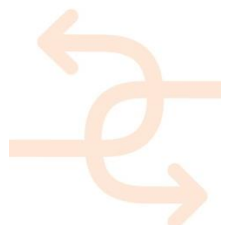

5.3.1 Deflection and geometric tolerances

Aluminium has many advantages as a curtain wall framing material, but it has the distinct disadvantage of deflecting approximately three times as much as steel does for a given load. Even when the amount of deflection does not compromise the strength of the aluminium members, it still may pose a danger in that the glass may be forced out of place. To protect against excess deflection, mullions are extruded into shapes that maximize the area moment of inertia, or resistance of a particular cross-sectional shape to bending stress. Wide-flange elements, such as I-beams, have particularly high area moments of inertia, which is why this profile is used so often in construction. To reduce deflection in a curtain wall assembly without adding excess depth to the frame profile, steel reinforcement may be added to aluminium mullions. This method protects the steel from exposure to the elements, while taking advantage of its load-bearing properties. However, water penetration into a steel-reinforced system can also lead to deflection as the steel corrodes and expands, causing the aluminium to bow outward.

5.3.2 Poor thermal performance

Overall curtain wall thermal performance is a function of the glazing infill panel, the frame, construction behind opaque (spandrel and column cover) areas, and the perimeter details.

Curtain wall frame conductance is a function of the frame material, geometry and fabrication (e.g. thermal break).

Aluminium has a very high thermal conductivity, therefore, it is common practice to incorporate thermal breaks of low conductivity materials, traditionally PVC, Neoprene rubber, polyurethane and more recently polyester-reinforced nylon, for improved thermal performance. Some curtain wall systems utilize "pressure bars" that are fastened to the outside of the mullions to retain the glass. These systems frequently include gaskets that are placed between the pressure bar and mullions and function as thermal breaks and help with acoustic isolation. These systems require special care in construction to ensure continuity of the gaskets at horizontal and vertical transitions. Gaskets are also used to cushion the glass on the interior and exterior faces of the glass. The problem with gaskets is that they tend to be stretched during installation and will shrink back to their original length in a short time; they will also shrink with age and exposure to ultraviolet radiation. There is usually a gap in the gasket at the corners after shrinkage occurs.

With a properly designed system the water that enters the system at the gasket corners will weep out through the snap cover weep holes. To mitigate shrinkage of gaskets back from the corners the use of vulcanized corners and diagonally cut splices are recommended and their proper installation and status shall be checked during inspection.

At the curtain wall perimeter, maintaining continuity of the air barrier reduces airflows around the curtain wall. Integration of perimeter flashings helps ensure watertight performance of the curtain wall and its connection to adjacent wall elements. Proper placement of insulation at the curtain wall perimeter reduces energy loss and potential condensation issues. Insulating the mullions in a spandrel area may lead to excessive condensation in cold climates unless it can also be assured that humid air from the interior will never come in contact with the mullions.

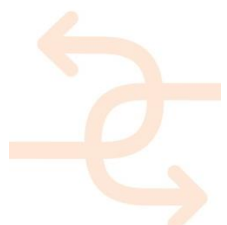

5.3.3 Humidity and moisture damages

One of the most common types of failure in curtain wall sections is moisture damage. Damage from water infiltration includes premature deterioration of the wall structure, finish damage, mould and mildew, and decreased interior air-quality⁵. Unlike discontinuous windows, which are smaller units and can rely to a high degree on sill flashings to capture frame corner leakage, curtain walls cover large expanses of wall without sill flashings at each glazed opening. Water penetration of curtain wall frame corners is likely to leak to the interior and/or onto insulating glass below. Watertight frame corner construction and good glazing pocket drainage are critical for reliable water penetration resistance. Repairs from poor water protection are often expensive to fix, but can be easily prevented in initial construction of the curtain wall. Moisture damage can be classified into two distinct parts. The first being water infiltration while the second is condensation.

Water infiltration creates the largest potential for moisture damage in a building. Sealants are the primary use of preventing water penetration into a curtain wall; however, sealants can break apart. Poor adhesion can cause the sealant to break away. The thermal expansion coefficient of aluminium is 2.5 times that of glass, the large relative displacements often cause sealants to break. A perfectly watertight curtain wall cannot be maintained by sealants alone. The general rule of thumb when concerning water penetration in curtain walls is not to rely entirely on sealant. Sealants are not perfect. Sealants break, pull away, or cannot be installed correctly. The best way to avoid water damage is to have redundancy in water protection, by incorporating an in-wall drainage system along with careful consideration of a proper sealant. In water repair situations, engineers/architects should consider adding a second line of defence, if possible. In order to properly ensure an effective curtain wall design, laboratory and field mock-ups are necessary. Curtain wall sealants are only designed to last 10 to 15 years; therefore, regular inspection, maintenance and upkeep of sealants is a must to prevent damage.

Condensation occurs when the temperature of the glass or aluminium frame in a curtain wall reaches the dew point temperature of the interior space conditions. Water forms on the surface of the glass or aluminium, and can cause damage to the unit. Laboratory tests simulating indoor and outdoor air temperatures and humidity of the space is good practice to see how a glass panel will perform. A great way to prevent condensation in frames of curtain walls is to use thermally broken aluminium. Thermal breaking is where a piece of plastic is incorporated in the frame, which significantly decreases the heat flow in (or out) of a curtain wall. This reduction of heat flow raises the surface temperature of the aluminium, and decreases the possibility of condensation on the aluminium.

Another prevention which can be incorporated in design is limiting the amount of non-thermally-broken aluminium exposed to exterior conditions⁶. Many mistakes have been made in curtain wall waterproofing design in the past. Being informed of proper waterproofing techniques and learning from past mistakes can help prevent future waterproofing failures.

⁵ Schwartz, Thomas A. (2001). "Curtain-Wall Fundamentals." Association for Preservation Technology International (APT) Bulletin, Vol. 32, N.1

⁶ Vigener, Nik and Brown, Mark A. (June 7, 2010). "Building Envelope Design Guide-Curtain Walls." Whole Building Design Guide, Last updated: 06-25-2012

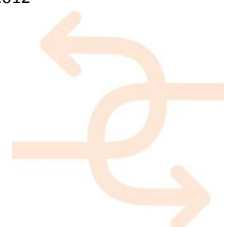

5.3.4 Glass Failures

Glass failures in curtain walls can be split up into several different categories. NiS inclusions, thermal cracking, and damage from impact are the most common types of glass damage. NiS inclusions are imperfections incorporated in the glass when it is manufactured. NiS remains at high temperatures, after the rest of the glass has cooled. After the NiS cools, the inclusions expand in volume and crack the glass. This effect is most commonly seen in tempered glass. In order to stop NiS inclusions from cracking in a curtain wall, the engineer should consider not using tempered glass, or perform a heat soak test.

Thermal cracks may also occur in the glass when large temperature differences in the glass cause high stresses within the pane, forcing the glass to crack. Thermal cracks are easy to detect because they perpendicular to the frame and usually expand the whole window section. Failures are more likely to occur when an absorptive coating is placed on the glass. These coatings are put in place to reduce the cooling load of the building, but can come at a cost to the glass integrity because they absorb solar radiation and keep it stored in the glass. The stored energy increases the temperature of the glass, and can cause it to expand unevenly, creating a crack. The more effective (i.e. more sun absorbed) the more likely the glass is to crack. If the glass support allows some movement, the likeliness of a thermal crack occurring decreases slightly.

5.3.5 Poor acoustic performance

The acoustic performance of curtain walls is primarily a function of the glazing and internal seals to stop air leakage. The sound attenuation capability of curtain walls can be improved by installing sound attenuating infill and by making construction as airtight as possible. Incorporating different thicknesses of glass in an insulated glass unit will also help to mitigate exterior noise. This can be accomplished by increasing the thickness of one of the lines of glass or by incorporating a laminated layer of glass with a noise-reducing interlayer, typically a polyvinyl butyral or PVB.



Figure 18: Loose gaskets or seals

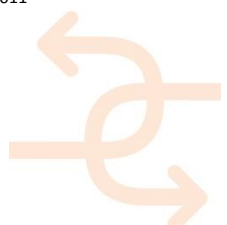

Figure 19: Streaked glazing



Figure 20: Gaskets disengaged from glazing

7 McCowan, Derek B. and Kivela, Joshua B. (2011) "Lessons Learned From Curtain Wall Failure Investigations" Simpson, Gumpertz, and Heger Report, 2011



5.4 Relevant INSITER KPIs and to-be-measured parameters for prefab glass modules (including use of measurements devices)

Curtain wall failures can be prevented by proper consideration of potential failures and ensuring proper installation and maintenance of curtain wall sections. A preliminary condition consists of the evaluation of the geometric asset of the assembly that can cause undesired deflection and related failures in terms of performances.

In accordance with INSITER and Piaia, et. al., 2015 structure, the following KPIs can be addressed as more relevant for glass curtain walls:

For **energy efficiency**, these parameters are crucial:

- a) Dimensional accuracy and tolerances - Geometric conformity of elements
- b) Thermal bridge evaluation (Incidence Factor as defined in D5.1 and 5.1)
- c) Thermal transmittance (U-value) of the components: glazed modules, metal frames
- d) Air tightness (preventing air leakages)
- e) Water- and vapour-resistance (μ)
- f) Sound insulation (dB)
- g) Fire safety (min)
- h) Appropriate material selection and application

For **indoor environment quality**, these parameters are crucial:

- a) Thermal temperature on the inner side of the facade ($^{\circ}\text{C}$)
- b) Airtightness (preventing sound transmission)
- c) Acoustics (dB)
- d) Visual comfort

Typical errors during assembly phases and KPI assignment are shown in Tables 21 and 22, that provide an overview about application of tools, measurement needs and expected solutions in order prevent errors.

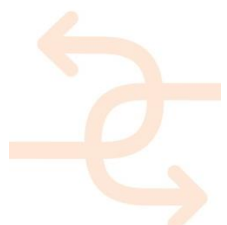

Connection façade modules	Type of error	Relevant norms	Relevant KPI's and values	What to measure?	How to measure?	Who is problem owner? Who to inform?	What is current practice?	How to address the problem?	How to prevent error in future?
	Lack of dimensional accuracy of single prefab façade element	DIN 18202: 2013-04 Toleranzen im Hochbau as a general reference. Each system normally presents allowable tolerances	Heat transfer (air tightness, U-value, thermal bridges, g factor) and Indoor environment quality (thermal, acoustics)	Geometry, Deflection, Out of plumb	Visual check, 3D laser scanner compared with BIM model, check technical specifications	Façade supplier. Inform project manager/coordinator and/or Owner	Correct misalignments if possible or replace the incorrect element (new material submission)	Clarify with problem owners by project coordinator	Improve quality check at delivery. Feedback to the facade supplier
	Deformation of the supporting frame (if existing)	Eurocodes and product standards, depending on frame material (steel, timber, concrete etc.)	Heat transfer (air tightness, u-value) Indoor environment (thermal, acoustics)	Geometry, Deflection, Out of plumb, Corrosion	Visual check, 3D laser scanner compared with BIM model, check technical specifications	Assembly team. Inform Project coordinator in case of problems	Correct misalignments if possible or replace the incorrect element (new material submission)	Clarify with problem owners by project coordinator	Identify cause of error and take corrective steps in earlier stages of building process
	Defects in sealing between façade modules	1. Blower door test EN 13829 2. Airborn sound insulation EN-ISO 16283-3 3. Heat transfer EN-13187	Heat transfer (air tightness, u-value) Indoor environment (thermal, acoustics)	1. Air tightness 2. Airborn sound insulation 3. Heat transfer	1. Ultra sound or blower door test (when building envelope is closed) 2. Sound Brush 3. IR Camera	Assembly team. Inform Project coordinator in case of problems	Corrective actions as early as possible	Clarify with assembly team	Check incompatibility with other materials
	Defects in water/vapour stopping	Each system normally provide installation detailing	Indoor environment quality (humidity)	Humidity	3D laser scanner, IR Camera and visual check	Assembly team. Inform Project coordinator in case of problems	Corrective actions as early as possible	Clarify with assembly team	Identify and control situation where most problems with water and vapour resistance layer occur

Table 21: Glass façade assembly – connection between modules



Connection between façade module to building structure	Type of error	Relevant norms	Relevant KPI's and values	What to measure?	How to measure?	Who is problem owner? Who to inform?	What is current practice?	How to address the problem?	How to prevent error in future?
	Unpredicted deflection or deformation of the building structure	UX60 UNCSAAL - Italy ; DIN 18202: 2013-04 Toleranzen im Hochbau	Heat transfer (air tightness, u-value) Indoor environment (thermal, acoustics)	Geometry	Levelling, 3D laser scanner compared with BIM model	New construction: incorrect realization of the structure by Contractor. Refurbishment: deformation depends on actual "building history" and	Corrective adjustments in the structure if possible. As an alternative, provide tailor-made facade elements to fit the actual situation	Clarify with problem owners by project coordinator	Identify cause of failures and take corrective steps in earlier stages of construction process
	Incorrect anchoring and fixing of the facade structure to the building structure	Eurocodes and product standards, depending on structure material (steel, timber, concrete etc.)	Heat transfer (air tightness, u-value) Indoor environment (thermal, acoustics)	Geometry	Visual check of reference lines	Assembly team. Inform Project coordinator in case of problems	Corrective adjustments in the structure if possible. As an alternative, provide tailor-made facade elements to fit the actual	Clarify with assembly team	Identify cause of failures and take corrective steps in earlier stages of construction process
	Defects in sealing between façade modules and building structure	1. Blower door test EN 13829 2. Airborn sound insulation EN-ISO 16283-3 3. Heat transfer EN-13187 4. Each system normally provide installation detailing.	Heat transfer (air tightness, u-value) Indoor environment (thermal, acoustics)	1. Air tightness 2. Airborn sound insulation 3. Heat transfer	1. Ultra sound or blower door test (when building envelope is closed) 2. Sound Brush 3. IR Camera 4. Check consistency with tech specs for the assembly system.	Assembly team. Inform Project coordinator in case of problems	Corrective adjustments on sealings if possible. Otherwise, remove the sealing and provide new sealings	Clarify with assembly team	Identify and control places where most problems with sealants occur
	Problems with water and vapour resistance layers	Each system normally provide installation detailing	Indoor environment (humidity)	Humidity	3D laser scanner and visual check. Check consistency with tech specs for the assembly system.	Assembly team. Inform Project coordinator in case of problems	Corrective actions as early as possible	Clarify with assembly team	Identify and control situation where most problems with water and vapour resistance layer occur

Table 22: Connection between modules and background structure

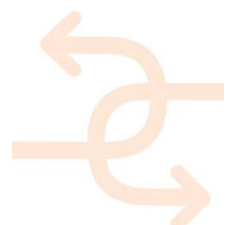

Measuring relevant parameters at different stages

Stage 1

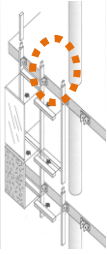
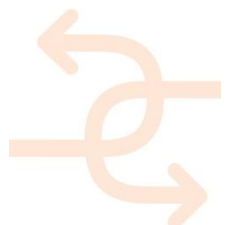
Correctness of the placement of the glass façade module.

Before the mounting of the façade element the dimensional correctness of the element in relation with the bearing construction should be tested. (**Geometric discrepancy** by using 3D laser scan, also refer to table below, point 3 **Geometric survey and allowable tolerances.**)

Stage 2

Air tightness of the whole glazed building envelope. Only after the building envelope is sealed, the following **further analysis** can be carried out:

Tests for water penetration use a calibrated spray rack system with a positive air pressure differential to simulate wind-driven rain. EN ISO 9972:2015 and ASTM E783 specifies different test procedures for determining field air leakage at specific pressures.

Glazing that displays systematic scratches or other defects after installation may need to be evaluated for structural integrity. In such cases, a representative sample of glass units may be removed and tested under laboratory conditions.

Measurement of the airtightness by using a blower door test (in accordance with EN 13829 procedures)

Measurement of the airborne sound insulation of the façade (GA;k), airborne sound insulation between buildings (Dn,T,A,k) and contact sound insulation between buildings (Ln,T,A)

Measurement of the heat transfer by using a thermal camera. Please note the specific condition when you can make a good thermal image of the building envelope.

Measurement of the humidity by using a 3D laser scanner to detect moisture and water problems.

Stage 3

Functionality of the façade during in-use phase.

Please Note: The service life expectancy of components that are coupled with the curtain wall into an assembly should match the service life expectancy of the curtain wall itself. Require durable flashing materials, non-corroding attachment hardware and fasteners, and moisture resistant materials in regions subject to wetting. Therefore inspection procedures for these types of assemblies are applicable in different stages of their life cycle, also depending on the level of prefabrication of the project:

- For projects with a significant amount of custom curtain, wall laboratory testing of a mock-up curtain wall are required prior to finalizing project shop drawings.
- For all types of curtain walls, stock or custom, it is required the construction and testing of a field mock-up representative of the wall/window assembly. This is best scheduled prior to the release of shop drawings for window production, so that there is an opportunity to make design changes based on the test performance of the field mock-up. Such field tests be conducted by an independent third party accredited agency.
- Field testing of curtain walls are required for air infiltration and water penetration resistance, for quality assurance of curtain wall fabrication and installation. Multiple tests are required with the first test on initial installations and later tests at approximately 35%, 70% and at final completion to catch problems early and to verify continued workmanship quality. Additional testing needs to be performed if initial tests fail.



- In case of refurbishment, a preliminary analysis of building envelope performance and an assessment phase is fundamental to evaluate the actual condition and to constitute the basis for further design decisions. Field inspection carried out with visual check, non-destructive testing and monitoring techniques are a support.
- Maintenance phase: if leaks, deflection, etched glass, or other issues have become a concern, a systematic evaluation of the curtain wall system shall be conducted, beginning with close visual inspection. Some international organizations (i.e. ASTM International) provide test standards for the evaluation of air and water penetration, as well as structural performance of glass in curtain wall applications.

The following steps should be performed:

	Check to be done	Who is responsible	Description
1	Defining the test boundary	Project coordinator with the support of skilled inspector	The test could be limited only to a limited portion of the façade, be extended to a one-story cluster, or , in case of tests for air sealing assessment, it may even involve the inner space of the building. The INSITER inspection manual should be a flexible “tool”, in order to be adapted and be used in different scenarios. over time

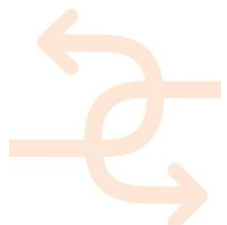

2	<p>Visual inspection and checklists: The effectiveness of visual inspection relies on the experience of each inspector, but a higher degree of objectivity can be obtained by standardizing procedures. The inspection will address:</p> <ul style="list-style-type: none"> • Integrity and structural stability • General aspects of façade elements • Presence of deposits or debris • Condition of glass panes (cracks, humidity) • General condition of finishing • General condition of sealing • Curtain wall details (mullion covers, mullion out of line, loose trim) • Presence of gaps 	Skilled inspector	<p>Monitoring and recording of the phenomenon over time. For INSITER project, the proposal is to integrate on a software platform a series of checklists with specific questions to which the inspector will have to respond with Yes / No, or via a coded series of answers like:</p> <p>IR = Immediate Repair NI = check at Next Inspection Y = Yes, no problem detected</p> <p>The result of those different questions, with the prevalence of negative or positive feedback, will lead to a preliminary qualitative assessment about the condition of the façade and its components. Furthermore, if a reference BIM model is available or can be easily obtained (i.e. a local BIM model of the envelope carried out via Laser Scanner), the results shall be directly integrated on INSITER platform, in order to have an exact location of the main defects.</p>
---	---	-------------------	---

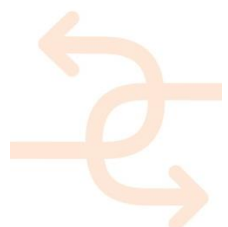

3	Geometric survey and allowable tolerances.	Skilled inspector	<p>The tolerances will be defined with respect to three axes defined as follows:</p> <p>X axis: horizontal, in the facade plane, positive to the right;</p> <p>Y axis: vertical, in the facade plane, positive upward;</p> <p>Z: horizontal axis, in the plane perpendicular to the facade, positive towards the inside of the building.</p> <p>Tolerances generally relate to significant points of interaction façade / structure that is to the points that are used for securing the attacks. Any significant point of the structure that interacts with the facade could not be further away from its theoretical position, as per the reference BIM model, +/- 25 mm in the direction of the three axes defined above.</p> <p>Locally, the following stricter tolerances are applied as a threshold:</p> <p>distance between two successive columns or load-bearing walls (X- and Z): ± 20 mm</p> <p>height between two successive decks (Y-axis): ± 20 mm</p> <p>misalignments between two successive decks (Z axis): ± 20 mm</p> <p>height difference from similar points of the same deck (Y axis): ± 10 mm</p> <p>misalignments between points of a same column (Z axis): ± 10 mm</p>
---	---	-------------------	---

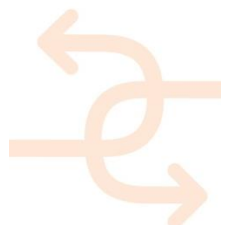

4	Measurement of parameters.	Skilled inspector	<p>NDT shall be preferred and calculation methods within INSITER project are described more in detail in WP2 and WP5. The calculations are based on applicable reference standards and the thresholds of acceptance normally are based on a country-level. Nevertheless, calibration completed for this project and ISO standards (ISO 10211-2007) acknowledge that constant heat transfer coefficients can be applied to entire surfaces to yield accurate predictions of U-values of building envelope components. Assessment methods and devices that can be applied for glass façades are briefly outlined in the next paragraphs. In general, the validity of any detailed calculation method is best checked against measured data. Measured U-values should always be sought as a means of checking the accuracy of a calculation. For instance, in the U.S. rating system is used for windows and doors (NFRC 100), analysis are carried out using a detailed calculation method to assess the performance of a complete range of products, and the two products showing the extremes of performance are then measured as a check against the validity of the analysis: this kind of approach combines the speed of calculation with the certainty of measurement.</p>
19	Placement of highly reflective elements that concentrate solar reflection directly on the element sealing	Specialized operator	Opacification and / or shielding of the reflective surfaces, to avoid any deterioration of the seal element. Monitoring and recording of the phenomenon over time
20	Absence localized (for removal) of protective layers or ballasting initially provided	User and / or specialized operator	Repositioning or protective element recovery
21	Presence of potentially aggressive chemical emissions (industrial chimneys or vents on the roof or in the immediate vicinity)	Specialized operator	Possible washing and or the sealing recovery, adoption of suitable measures to prevent the emission and / or sealing element contact with aggressive chemicals

Table 22: Steps to perform

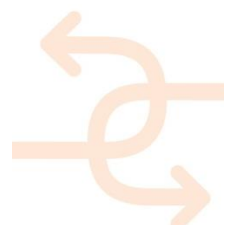

5.4.1 Focus: calculation of heat transfer for glazed units

The reduced thermal resistance due to thermal bridging through steel framing and panels can have a significant impact on the whole envelope energy performance.

Cold- or thermal-bridges are sections through the fabric of significantly lower thermal resistance than the rest of the construction. These happen particularly around openings and at junction of walls/floors and walls/roofs. Concrete and metal framed buildings or facades are particularly prone to cold-bridging unless these elements are individually insulated. Cold-bridging is the result of localised areas of low thermal resistance caused by the presence of elements with a high thermal conductivity.

Typical examples are non-thermally broken metal frames, concrete frames, openings.

The result of thermal-bridging is localised areas of increased heat loss/gain and possible increased condensation risk, mould growth (which can also cause respiratory and other allergies in sensitive people), pattern staining and corrosion.

The thermal performance of a facade is normally expressed in terms of the thermal transmittance or U-value which is the reciprocal of the resistance per unit area. Heat flow through the facade and U-value are related by the following formula:

$$U = Q / A \Delta T$$

U is the thermal transmittance in W/m²K

Q is the heat flow in W

A is the area of the facade or component in m²

ΔT is the difference in environmental temperature across the facade in K

A Y - value represents the additional heat transfer through an otherwise uniform component that is caused by some linear feature of the component, such as for instance the extra heat flow through a plane layered component caused by a non-plane edge.

The total heat transfer through the component is then expressed in terms of the theoretical centre-panel U-value, which assumes that the whole of the component performs as the plane layered part (i.e. according to the simple one-dimensional calculation plus a linear transmittance (Y- value), which relates the additional heat loss to the length of the linear feature (in this case the perimeter of the panel).

The total heat flow through the panel is then:

$$Q = (U A + Y L) \Delta T$$

Q is the total heat flow through the panel, in W

U is the theoretical centre-panel U-value of the panel, in W/m²K

A is the projected area of the panel, in m²

Y is the linear edge transmittance of the panel, in W/mK

L is the perimeter of the panel, in m

ΔT is the overall temperature difference across the panel, in K

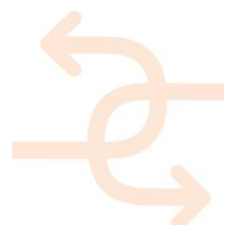

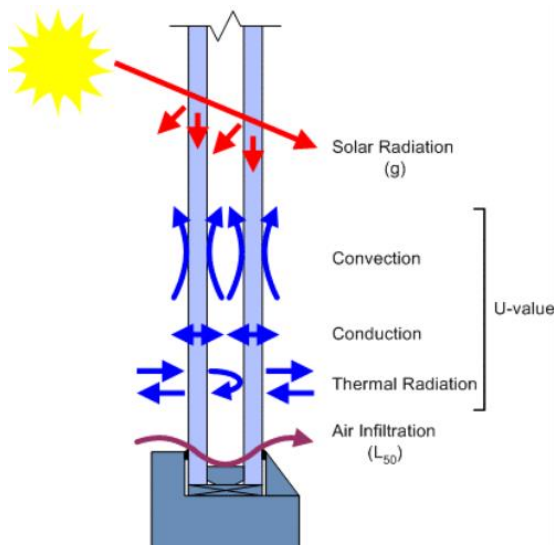

Figure 18: Representing U value

This formula indicates that the linear edge transmittance must be related to the average and theoretical centre-panel U-values.

In a real application the insulated panel/glazing would be mounted in a framing system, which would clamp or otherwise support (and thus interact with) the edge of the panel. The Y - value could therefore be seen as comprising two parts:

- A component Y - value, which is an intrinsic property of the panel/glazing itself, plus
- An interaction Y - value, which is an extrinsic property of the system.

These two Y - values are then added together to form the total Y - value. The component Y - value may be minimised by the panel manufacturer by good edge detailing but the interaction Y - value depends on the design of both the frame and panel. The linear transmittance Y is mainly affected by the conductivity of the spacer material.

EN ISO 10077-1 gives more detailed information about the use of the formula given above.

Parameters to be measured:

- U value: Solar factor heat losses and gains from conduction, convection and radiation arising from all the components of the curtain wall (frame and gaskets as well as double glazed units) for a specific size and design of curtain wall
- g: heat gain from solar radiation, $0 < g < 1$ (more solar heat gain)
- Y: linear transmittance
- L: heat losses from air infiltration through the curtain wall
- Interior Profile Temp °C
- Interior Glass Temp °C
- Humidity

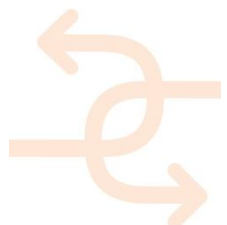

5.4.2 Focus: measurement devices and techniques

The reference norms and methods of calculation are listed in Piaia, et. al., 2015, Chapter 2.5 and measurements techniques are developed in D5.1 and D5.2, that offer an overview of INSITER measurement tools to be applied.

The main tools for inspection and the relevant measurements related to KPIs and parameters are:

- 3D laser scanner
- Geometrical accuracy in m, cm, mm; position identification in geo data format
- Thermal camera, thermometer, U value in $W/m^2 \times K$
- Sound brush, blower door test, air flow capture hood, air velocity meter
- Moisture meter, humidity in relative moisture description in %
- Microphone, sound intensity in dB
- Check on technical specifications of the products and material description

Measurement is generally considered the only way in which the 3-dimensional heat transfer processes are fully and accurately recreated. However, a test cannot be performed prior to manufacture of a prototype or sample, which may leave too little time to revise the design should it not perform as expected, and temperatures are rarely measured within the component, although surface temperatures will be recorded as part of the measurement procedure.

Measurement devices must be calibrated, and there are well-established and proven measurement standards which allow data to be adjusted to reference conditions. Measurement cannot usually be used to identify the U-values of the various parts of the sample (for example each of the different frame profiles and infill types in a large curtain wall specimen) but it does allow for the interactions between the components of the sample.

Standards are available for the particular type of measurement apparatus and can give guidance on suitable sample sizes and arrangements.

The *hot-box* is the principal laboratory-based apparatus, and is to be preferred for measurements. The sample is mounted in an insulated surround, between two thermally-controlled environments, and the heat transfer through the sample is measured. This is a device that is reliable but it cannot be used on site.

The *calorimeter* is a device which encloses one side of the sample. It therefore controls only one of the thermal environments (usually on the cold-side of the sample). The calorimeter allows the warm-side of the sample to be observed, which gives the assessor the opportunity to gain more data regarding surface temperatures, and may allow condensation to be observed.

Infrared thermography uses a thermal imaging camera to “observe” the surface temperatures of a structure. Useful in connection with in situ measurements, this technique usually requires additional temperature measurements from a reference surface for calibration. However, although infrared thermography may be used in combination with a calorimeter it should not be considered as suitable for measuring U-values until further work has been undertaken on standardisation.

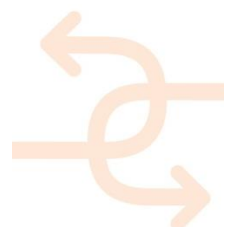

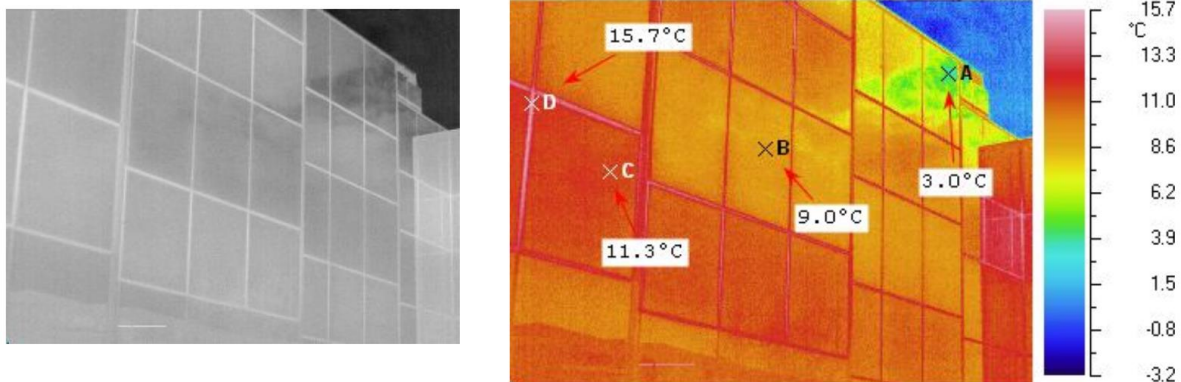

Figure 19: Infrared thermography uses a thermal imaging camera to “observe” the surface temperatures of a structure

In situ temperature measurement may be used to assess thermal performance by measuring surface temperatures and comparing them with predicted values. Such a method is readily calibrated by using a component with a known performance, for example a double glazing unit, as a reference. As with infra-red thermography this technique should not be used to assess performance other than as a diagnostic tool, where it is useful for checking that a facade has been properly designed and constructed.

The only significant issue with measurement of a component is to decide the size and arrangement of the test specimen; the test specimen should be a realistic representation of a component or system as it will be used.

The thresholds and acceptance level are mainly based on national, regional or local regulations, depending on the climate condition of the area and on the building use.

5.5 Calculation on KPIs

Since a common mandatory standard for glass curtain wall is not present, the quantification of the related KPIs depends on the energy demands for the building, based on either national building code requirements or voluntary energy protocols (i.e. LEED, BREEAM, Itaca Protocol).

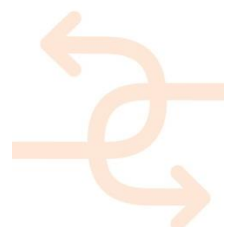

6. Critical EeB component 4: Building envelope – roof systems

6.1 General

Faced with a scenario of extremely broad technological proposals, the chapter analyses the different design solutions as a function of the most innovative construction technologies, without neglecting the role of the guide which technical standards for the design and installation.

The regulatory framework has changed over the years, paying particular attention not only to the aspects of the control of energy consumption in buildings, but also to those of security, acoustic and sustainable well-being. In light of the need to reduce energy loads of the building it was also imperative to identify good practices of building aimed at implementing the technological characteristics of the building envelope, redefined as a dynamic component from the energy point of view capable of regulating "positively" flows of incoming and outgoing energy from the building.

The roof, with its exposure characteristics, is a privileged place for the use and rational exploitation of solar energy. However, it should not be forgotten as the cover system is also affected by the phenomena connected from the collection and removal of rainwater and the problems of accumulation of snow, as well as from the aging processes of surfaces due to the increased exposure to the sun.

In Appendix 6, a typical assembly process is explained in more detail that can be used later as self-instruction.

6.2 Description of prefab roof systems

This paragraph is devoted to the technological management of a cover and contains the definition of basic data, the definition of performance, the type of selection criteria, the selection criteria of the stratigraphy, the criteria of choice of materials.

The logical sequence of design follows the following steps:

Level 1 - definition of intended use

Level 2 - identification of external and internal environmental conditions

Level 3 - definition of the coverage performance

Level 4 - choice of the type of coverage

Level 5 - choice and features of the elements and layers

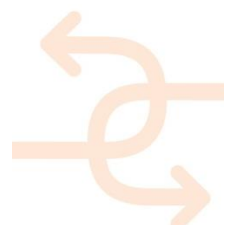

6.2.1 Level 1 - definition of intended use

A cover can be designed with different intended use:

- Only maintenance;
- Walkable in private or public;
- Driveway.

The intended use allows both to understand what are the loads present on the roof and what are the possible interactions with other agents induced by the intended use (for example, oil produced from motor vehicles).

It must be very clear that load acting on a cover is not just a purely structural issue.

In fact, just to make a small and simple example, it is clear that the transmission of the action of a wheel of a passenger car floor up from the coating to the carrier passes through all the layers and intermediate elements. If even only one of these was very deformable (for example, the heat-insulating element), it would generate deformations and tensions also on the other, with consequent risk of cracking.

So, the design of the mechanical characteristics of all the elements becomes fundamental.

6.2.2 Level 2 - identification of external and internal environmental conditions

The knowledge of the environmental conditions of the external environment in a building is necessary for the definition of the performance of a continuous coverage.

The research of climate data is not always easy because, at present, are not available full time series.

The extraction of the data, if not already available, must take place in a very careful evaluating, in particular the period of data reading time.

This section provides information on climate data for the design of the cover performance.

Identification of climatic elements necessary for the design of the cover performance

The necessity of normal climatic data for the design of a cover are the following:

- Maximum temperature and minimum outside air;
- Maximum relative humidity;
- Solar radiation
- Wind speed
- Rainfall intensity;
- Sound level;
- Intensity of snow.

The internal environmental conditions are related to the specific use and are commonly found in the specific regulations.

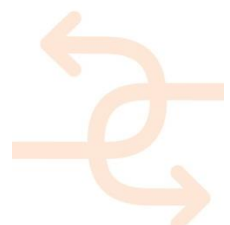

6.2.3 Level 3 - definition of the coverage performance

The definition of the coverage performance depends mainly from the intended use of the property (or the part underlying the hedge in question), the intended use of the cover and its location.

The most significant specific requirements of a cover are the following:

1. Mechanical resistance to static loads;
2. Mechanical resistance to dynamic loads;
3. Shock resistance;
4. In case of fire behaviour;
5. Resistance to chemical, biological, radiative;
6. Resistance to frost;
7. Watertight;
8. Air permeability;
9. Heat insulation;
10. Control of interstitial condensation;
11. Sound insulation.

In each of the above requirements a performance specification must be assigned. For leading the following considerations apply:

Mechanical resistance to static and dynamic loads

The structural design is not discussed in this article because there are specific regulations for its design.

Resistance to chemicals, biological, radiative

The layers and critical items that may come in contact with the agents listed above are:

- The sealing element;
- The insulation element (if it is of countdown coverage);
- The coating layers.

For the type of material chosen it should therefore be required a specific resistance, if possible, confirmed by a normed test.

Note that the most critical are for the organic-based elements, such as waterproofing membranes based on bitumen which, under the action of radiative agents may age, that is, lose its mechanical properties and water resistance.

It must be requested that this requirement will be reflected, apparently against the definition of specific characteristics for only the exposed elements.

Further attention is that of the action of hydrocarbons to which the synthetic membranes are sensitive.

For specific types, such as green roofs, it must also apply the resistance to the action of the roots that can only bind to the element seal.

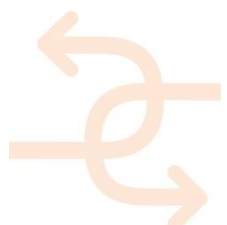

The common use of concrete screeds to the end of the sealing element protection from the action of the roots is not considered valid.

The use is admitted, only as an element of protection against mechanical impacts or similar sealing element only in special situations such as:

- The possibility of mechanical deterioration of the sealing element during phases of construction due to collision with equipment, temporary works of medium and high intensity;
- Prediction of maintenance unqualified.

Thermal insulation and reduce energy consumption

Coverage invests an important role in the monitoring of heat flows, both in summer regime is in winter conditions.

The two major technological requirements which affect - from this point of view- the design are the thermal and the thermal inertia transmittance.

It is important to emphasize that the definition of these requirements cannot be made considering divorced coverage than the rest of the building.

The present discussion therefore assumes that the definition of the performance specifications of these derives from a project overview.

Control of interstitial condensation

The control of interstitial condensation is possible is carried out according to EN ISO 13788: 2003 - "Hygrothermal performance of components and for building elements - Internal surface temperature to avoid critical surface humidity and interstitial condensation - Calculation method."

Control of the sound reduction

The sound insulation of a roof is essentially connected to the desired sound level for activities that are carried out in the environment to it below and depends on the level of sound produced in the environment surrounding the building.

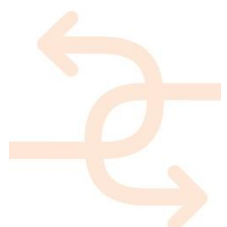

6.2.4 Level 4 - choice of the type of coverage

Each of these types of coverage presents specific characteristics and can be more suitable in certain conditions of use. In particular, for the continuous covers the main classification concerns the position of the seal:

- Cover with insulation element placed under the sealing element. It is necessary to adopt a layer for the control of the interstitial condensation; the insulation element must be able to withstand the thermal action connected to the welding of the waterproofing membrane operations (if carried out) or protected prior to these operations (usually during manufacture). The seal element is more protected from the heat of the sun (remains in thermal quiet) and can be laid in independence, semi-independence or in full adherence even if the latter system is recommended.
- Cover with insulation element placed above the sealing element. It is indicated where one wishes to avoid the use of a layer for the diffusion of the vapour control and assumes the use of a heat-insulating material with a very low water absorption by immersion is that by diffusion (the lowest possible!). The seal element is more protected from the heat of the sun and can be laid in independence, semi-independence or in full adherence even if the latter system is recommended.

There are also specific types such as green roofs or vehicular covers that are equipped with specific elements and layers and that must be designed as a system.

6.2.5 Level 5 - choice and features of the elements and layers

This chapter presents the major features to characterize the main elements and layers in order to comply with the conditions laid during the design phase and indicating the main types of usable material.

Thermal insulation element

The definition of the thermal insulating characteristics of the element is not limited to the indication of the minimum thermal resistance required value, in fact, also the following characteristics must be defined: deformation under load; It is very important considering the insistent loads on the cover. In fact, an excessive deformation leads to an increase of the thermal conductivity at the expense of thermal comfort and energy consumption. Typically, you have to assess the maximum deflection under the load of the project, according to EN 1605. The design load is the sum of the thermal insulation layer overlying loads considering employees' overloads on the intended use of the cover. Furthermore, for the deformations sensitive systems, such as tiles or the like, it asks a deformation of a few millimetres.

Long-term water absorption by dipping (in particular); It is considered when the insulating element is placed above the sealing element, since, in this specific position, can be long in contact with water. The recommended value is less than 0.5%, according to EN 12087: 2013.

fire resistance, according to EN 13501; It is required in particular cases, especially if thermal insulating element is then laid directly to flame the sealing element;

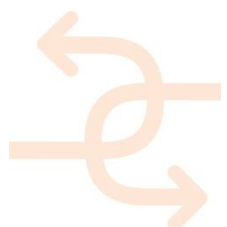

The types of product currently most used are:

- rock wool, has an indicative thermal conductivity around $0.036 \div 0.045 \text{ W / m} \cdot \text{K}$. Has good resistance to deformation (if high-density), a fire resistance class 0, a reduced production of smoke in case of fire, a good vapour permeability ($\delta u \cdot 10^{-12} \sim 150 \text{ kg / m} \cdot \text{s} \cdot \text{Pa}$). It has a fairly high water absorption and is not put in contact with water (it is not used in the reverse shell). It has a specific thermal conductivity about 20% greater than that of a sintered expanded polystyrene;
- glass wool, has an indicative thermal conductivity around $0.040 \div 0.045 \text{ W / m} \cdot \text{K}$. It has a good permeability to vapour ($\delta u \cdot 10^{-12} \sim 150 \text{ kg / m} \cdot \text{s} \cdot \text{Pa}$), a fairly high water absorption and is not put in contact with water (is not used in the backward shell), a reduced resistance to deformation, a resistance to fire class 0, a reduced production of smoke in case of fire. It has a specific thermal conductivity about 20% greater than that of a sintered expanded polystyrene;
- expanded polystyrene foam, has an approximate thermal conductivity around $0.035 \div 0.040 \text{ W / m} \cdot \text{K}$. Has a permeability of more reduced compared to rock wool or glass ($\delta u \cdot 10^{-12} \sim 1 \text{ to } 9 \text{ kg / m} \cdot \text{s} \cdot \text{Pa}$), a fire resistance very reduced, a rather high resistance to deformation to steam, it can produce smoke in case of fire;
- extruded polystyrene foam, has an indicative thermal conductivity around $0.033 \div 0.038 \text{ W / m} \cdot \text{K}$. Has a permeability of more reduced compared to rock wool or glass ($\delta u \cdot 10^{-12} \sim 1 \text{ to } 9 \text{ kg / m} \cdot \text{s} \cdot \text{Pa}$), a fire resistance very reduced, a rather high resistance to deformation to steam, it can produce smoke in case of fire;
- polyurethane, has a thermal conductivity around $0.028 \div 0.032 \text{ W / m} \cdot \text{K}$. It has a reduced vapour permeability more than the rock or glass wool ($\delta u \cdot 10^{-12} \sim \text{from } 1 \text{ to } 6 \text{ kg / m} \cdot \text{s} \cdot \text{Pa}$), a very low resistance to fire, a rather high deformation resistance, It may produce smoke in case of fire;
- cork, has a thermal conductivity around $0.045 \div 0.050 \text{ W / m} \cdot \text{K}$. Has a permeability of more reduced compared to rock wool or glass ($\delta u \cdot 10^{-12} \sim \text{from } 6 \text{ to } 10 \text{ kg / m} \cdot \text{s} \cdot \text{Pa}$), a class of reaction to fire reduced, a rather high deformation resistance to steam, may produce smoke in case of fire.

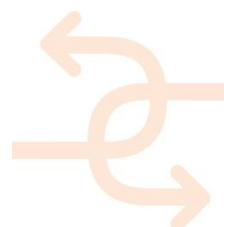

Waterproofing element

The main features to check are:

- The dimensional stability. A high dimensional stability is critical in order to avoid shrinkage of the waterproofing membrane. The reference standards are: EN 1107-1 (roofing membranes) and EN 1107-2 (synthetic membranes). Usual values of dimensional stability are around 0.5%.
- The cold flexibility. A high cold flexibility is a hallmark of good quality synthetic material and the bitumen. The normative references are in EN 1109 (roofing membranes) and EN 495-5 (synthetic membranes). The cold flexibility values of the bituminous membranes are not comparable with those of the synthetic membranes for the different chemical-physical characteristics. In addition to that they are not comparable between them the cold flexibility of elastomeric plastomeric bituminous membranes with those. In general, they require the following minimum values:
 - Synthetic membranes ≥ -35 ° C;
 - Elastomeric bituminous membranes ≥ -20 ° C (first layer) and -25 ° C (second layer);
 - Plastomeric bituminous membranes ≥ -10 ° C (first layer) and -20 ° C (second layer) measured according to those rules.
- Artificial aging by long term exposure to elevated temperatures. A reduced difference between the values of before and after the test is indicative of a propensity to maintain the performance over time. The characteristics to be compared are, essentially, the dimensional stability and cold flexibility. The reference is the EN 1296.

The membranes, as a whole, must meet the requirements of EN 13707 (roofing membranes) and EN 13956 (synthetic membranes). There must be a declaration of the manufacturer on the suitability for use of the membrane for application in green roofs.

The types of material most used are:

- Flexible elastomeric polymer bitumen membranes; are characterized by the presence of an elastomeric polymer, the SBS, which gives, in particular, flexibility at low temperatures; You can be laid in a single layer or multi-layer. They are armed with various types of armour, even composite, according to the use. Generally, they adopt thicknesses of 3 mm or 4 mm;
- Flexible plastomeric bitumen polymer membranes; are characterized by the presence of a plastomeric polymer, the APP, which gives, in particular, shape stability at high temperatures; You can be laid in a single layer or multi-layer. They are armed with various types of armour, even composite, according to the use. Generally, they adopt thicknesses of 3 mm or 4 mm;
- Synthetic flexible membranes, PVC. They are armed with various armour types depending on use. Generally, they adopt thicknesses of at least 1.5 mm.
- Synthetic flexible membranes, polyolefins. They may or may not be armed with various armour types depending on use. Generally, they adopt thicknesses of at least 1.5 mm.

It should be noted that, unfortunately, the design of a roofing system, is very complex (in this document have been given, for obvious space limitations, only very little information) and, normally or is not developed or is developed only in a small part.

One result is that about 50% of the damage on buildings is due to water (from various sources) resulting in rather serious economic problems.

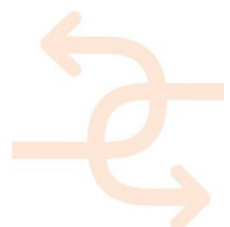

The wide availability of products available to generate, automatically, a high number of possible linear combinations: only a few of these are actually functioning is that at time zero up to the full useful life of the cover. The resulting acquaintances of the designer must be very extensive since, otherwise, it is unfortunately easy to make mistakes in the selection of a product or of a sequence of elements or layers, or still, the absence of layers that generates the activation of interactions that they can damage these materials.

6.2.6 The project covers with membranes with reflective trim

The surface temperature of a membrane exposed to solar radiation, so-called sun air temperature, depends on the air temperature, solar radiation on the surface, the angle between the surface and the solar radiation and the coefficient of absorption of solar radiation, α , which is related to the colour and surface structure of a material.

This phenomenon brings the temperature of most of dark colour surfaces, in summer, at temperatures very close to 80 ° C or more, which implies a possible high energy input in the form of heat within the environment below.

The higher the surface temperature of the membrane, at other factors being equal (thermal resistance of the cover, in particular) the longer the let-through energy flow through the cover with a consequent reduction of the welfare conditions of the underlying confined environments or an increase of the costs of climate control.

To reduce this phenomenon, there are various systems, such as those to realize roof gardens or to use very reflective surfaces and made the so-called "Cool Roof".

The main features of a cool roof must be:

- Low coefficient of absorption of solar radiation (α);
- High emissivity in the infrared;
- Durability of the surface properties;
- Reduced tendency to fouling.

Some manufacturers of waterproofing membranes have placed on the market membranes with reduced absorption coefficient (around 0.20) and high emissivity (around 0.90) in order to work on this concept. It 'also possible, for instance, to already laid membranes in work, operate with paintings that have similar behaviours.

They then realize waterproofing membranes light colour obtained by inserting in the compound of white colour pigments and reflective additives.

It is important to verify that these properties persist over time; In fact, otherwise, the above parameters are changed and the reflective power decreases.

For this purpose, they are under study, in fact, standardized tests and, therefore, by their nature, comparable, to evaluate the above properties, simulating a three-year exposure period.

The smaller the difference between the initial value and that after the aging test, the better the chances of keeping the valuable features in time. In case of strong reduction of this reflective capacity, due, for example, in particular the presence of pollutants, it may be possible, where indicated by the manufacturer, or to clean these surfaces, or repaint. A cover of this type has, in addition, for the community, the great advantage of reducing the effects of heat island (temperature higher than in urban areas around the surrounding) with consequent reduction of the production of pollutants.

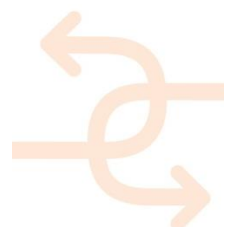

6.3 Summary of most frequently made errors affecting quality and performance of EeB

Considering the industrialized building realized with prefab components several errors can be committed during the construction and manufacturing task. The subsequent list proposes the main errors and the problems derived:

- Offsite manufacturing in conflict with the design;
- Poor manufacturing of the buildings components;
- Onsite manufacturing in conflict with the design;
- Assembly of damaged building components;
- Incorrect or mistaken assembling of the building components;
- Poor component locations or improper installation;
- Misinterpretation of incorrect use of the documentation (e.g. technical drawings);
- Omission or assembly of building components differing from the final design;
- Geometric problems of the building components;
- Installation of unsuitable material;
- Windows and doors incorrectly sealed on-site;
- Irregular site inspection by the project manager.

Errors resulting from non-enterprise suitability of installation, wrong implementation of elements and layers are:

- No undertaking suitability of installation (testing, using sample testing of the correctness of implementing operations);
- Coverage has not been cleaned before laying;
- Adverse environmental conditions of running (with fairness as indicated in the product data sheets);
- Wrong execution geometry (congruity with what is indicated by the designer and / or of the product application manual);
- Wrong mode of execution (congruity with what is indicated by the designer and / or application of the product manual);
- Incorrect protection mode (adequacy of the type of protection for any subsequent processing and in relation to climatic conditions laid down in the period after laying);
- The absence of the removal of specimens for sampling (execution of sampling as indicated in the contract).

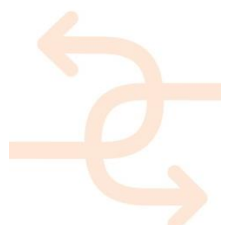

Errors in the execution of the sealing element can be listed in the following:

- Temperature and relative humidity ineligible, the presence of dust, the presence of ice;
- Incorrect arrangement of elements and layers;
- Wrong anchor fixation of the mounting support (adhesion to the membrane, verticality) and laying geometry with respect to the membrane (away from the edges) and with respect to the fixing scheme envisaged in the project;
- Presence of effect "peeling" (tensile forces, present at the foot of the flaps (retreats for dimensional memory of the membranes of the armature), which act between the horizontal and vertical surface of the waterproof lapel, detaching it from the support);
- Wrong width of the longitudinal and transversal overlap: -20% of the maximum value specified by the manufacturer, for bituminous membranes and up to -10% relative value indicated by the manufacturer for synthetic membranes;
- Wrong mode of adhesion between the various layers;
- Wrong mode of adhesion to the substrate.

	<p>The sealing element, in polymer-bitumen membranes, in the presence of cushioned-edge prefabricated fitting, due to the normal variation in size horizontal (dimensional memory), during the hottest time of year, it can act with "peeling effect" to the vertical lapel foot causing him detachment of the membrane.</p>
<p>1. cementitious monolithic structural support, with the gradients screed 2. perimeter containment wall 3. The vapour barrier layer 4. layer of primer 5. insulating element 6. cushioned-edge prefabricated siding 7. bitumen membrane in the polymer forming the sealing element.</p>	<p>8. vertical turn in polymer bitumen membrane 9. direction of traction of membranes constituting the sealing element 10. detachment for "peeling" effect of the membrane on prefabricated cushioned-edge 11. possible perimeter path of the water infiltrated into the points of discontinuity constituents present on the membranes of the sealing element</p>

It is still important to consider that INSITER aims to reduce the existing gap between the design requirements in comparison to the real construction proposing innovative methods for self-inspection (to detect errors) and self-instruction (to reduce and prevent errors).

It is clear that the identification of construction defects (errors) and subsequent validation of the protocol will be supported by "quantitative methods" that propose progressive tasks to detect existing faults or construction defects onsite.

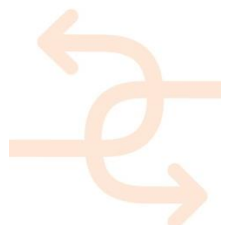

It is expected that the quantitative methods, used for measuring the defects impact, will follow these main steps:

- a) Identification of defect typology in relation to the related requirements, norms and standards;
- b) Defect assessment using tools, instruments and software (INSITER assessment tools);
- c) Defect evaluation based on the KPIs, measurements aspects and parameters, norms, standards or design technical specification.

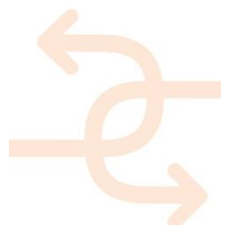

6.4 Relevant INSITER KPIs and to-be-measure parameters for prefab roof system (including use of relevant measurement devices)

The INSITER Tool KPIs “say” something about the effectiveness and efficiency of the INSITER tool and methodology through supporting self-inspection & self-instruction processes. These KPIs show whether INSITER methodology adds value in comparison to the ‘traditional’ instruction and inspection processes. Based on these Indicators the stakeholders can decide on the approach they want to adopt for their project: the traditional way or the INSITER way. The measurements and validation of these KPIs are strongly dependent on the project and building type, implemented inspection instruments, training and cultural issues related to involved companies. (Piaia et al. 2015 - Chapter 4)

The roof is an important part of the building envelope and has an important impact on the realisation of the relevant INSITER KPIs of energy efficiency and the indoor environmental quality.

For energy efficiency, like for all other envelope elements the following generic technical requirements for realising quality assurance are relevant:

- a) Dimensional accuracy / joints / tolerances
- b) Thermal transmittance reduction (U-value)
- c) Structural Stability
- d) Air tightness (thermal relevance)
- e) Water- and vapour-resistance (μ)
- f) Sound insulation (dB)
- g) Fire security (min)
- h) Appropriate material choice and application

For indoor environment quality, the following technical requirements for realising quality assurance are relevant:

- a) Thermal comfort (reducing overheating)
- b) Airtightness (preventing draught and improve sound insulation)
- c) Acoustics (dB)
- d) Visual comfort by daylight

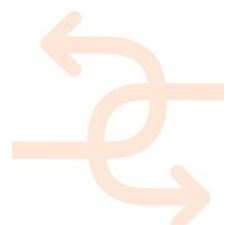

The relevant parameters to be measured are on three different stages:

Stage 1

Correctness of the placement of the element of the roof

This process is the same as described in chapter 4, section 4.5, Stage 1, p. 61.

Stage 2

Correctness of the roof construction

The activity has as its purpose the verification and control of the suitability of the substrate made from time to time for the elements and subsequent layers. The checks that are performed depend on the specific technical solution.

The following are the main controls for the various elements and layers:

1. Bearing structure: flatness, absence of roughness (if it is a support element pierceable or paste);
2. Layer of control to vapour diffusion (vapour barrier): the layer continuity, presence of vertical joints and connection to the element seal;
3. Separation layers in general: the layer continuity, presence of vertical joints;
4. Supporting layers in general: the absence of roughness, flatness, moisture content, presence of water, ice, cleaning, texture, empty, pull-out resistance of mechanical fasteners (if any);
5. Finishing layers in general: flatness, the laying geometry;
6. Control of the suitability of the construction details.

As other parts of the building, the roof must be checked for the KPIs with the following measurements:

- Measurement of the airtightness by using a blower door
- Measurement of the airborne sound insulation of the roof
- Measurement of the heat transfer by using a thermal camera.
- Measurement of the humidity by using a 3D laser scanner to detect moisture and water problems.

Stage 3

Correctness of the roof during in-use phase

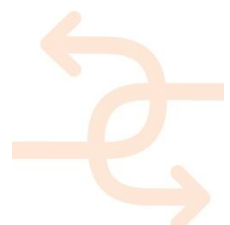

The following inspection should be done:

	Checking to be done	Type of resource	Action
1	General appearance of the cover with reference to visible abnormalities, such as for example corrugations, ripples, bubbles and surface alterations of the sealing element.	Specialized operator	Monitoring and recording of the phenomenon over time
2	General finishing aspect of hedging or protection or ballasting of the sealing system, such as for example injuries, dislocations, sinking, disruptions, displacements, drilling, cuts and cracks relating to fixed guards and their joints	Specialized operator	Monitoring and recording of the phenomenon over time. Possible restoration.
3	Presence of deposits on the covering system (for example, leaves, soil, deposits in the presence of water stagnation, forms of plant and animal life)	User and / or specialized operator	Removal of deposits and possible localized cleaning; eventual recovery (by operator specialized) of the sealing element
4	Debris (eg crocks, bottles, scrap) and materials, objects in general (eg packaging, tools, abandoned machinery) on the cover system	User and / or specialized operator	Removal of debris; control of the correct use of the covering system and possible localized cleaning; possible restoration (by the operator specialized) of the damaged parts
5	Hydraulic functionality of the collection and disposal of storm water system (channels, valleys, drains, downspouts, wells, too full, grids, cages, leaf guard / Gravelgrate)	User and / or specialized operator	Removal of any deposits and / or blockages, cleaning items and top up (by the operator specializing) the elements no longer functional or new installation
6	Stability of terminals and plant devices (eg chimneys and / or vents fireplaces or fans or extractors, basements, media, life lines) And integrity of their connection to the element seal	Specialized operator	Eventual restoration of stability, of the terminals, of the devices and hydraulic continuity with the sealing element

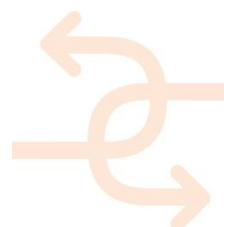

7	Integrity and water tightness of the sub-systems and additional elements and accessories (For example skylights, windows dished, systems of evacuation of the fumes, thresholds) present on the roofing system and of their connection with the sealing element	Specialized operator	Eventual recovery of seals, the seals, the hydraulic continuity with the sealing element and possible replacement of the damaged elements and / or no longer functional
8	Functionality and integrity of the expansion joints of hydraulic seal and / or mechanical	Specialized operator	Any mechanical restoring the integrity and / or hydraulic
9	Water tightness of flashings, caps perimeter crowning, wall profiles, gutters with particular reference to the fixings and the sealing, usually linear and point	Specialized operator	Possible restoration of seals, hardware and flashings and their accessory items
10	Presence of flaking and / or cracks spread the paint finish and / or protection	Specialized operator	Recovery operations with monitoring and recording of the phenomenon over time
11	Presence of deformation or injury of the mechanical element in correspondence hardware sealing	Specialized operator	Recovery operations with monitoring and recording of the phenomenon over time
12	Presence of phenomena of extraction of the support element of the mechanical hardware of sealing and / or the thermal insulation	Specialized operator	Possible localized cutting of the seal, removal and replacement with a suitable fastening. Cleaning of the sealing element and restore the impermeability
13	Presence of desoldering or detachment at the element joints sealing	Specialized operator	Recovery operations with monitoring and recording of the phenomenon over time
14	Presence of lesions in the current part or at particular points	Specialized operator	Recovery operations with monitoring and recording of the phenomenon over time
15	Presence of dislocations, cracks or deformation on the possible action of the stationary heavy protections on vertical joints	Specialized operator	Removal, in all its thickness, the fixed guard portion, which has its effect on the vertical element flap sealing; restoration work on the estate
16	Presence of dislocations, cracks or deformation on the possible action of the heavy furniture protectors on the lapels	Specialized operator	Removing the mobile guard portion that has its effect; restoration work on the estate
17	Presence of settlements, injuries and displacements of the systems stands.	Specialized operator	Reporting to the Property for verification and possible interventions on possible risks

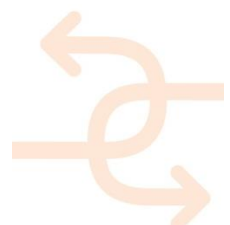

18	Functionality of the plant devices subservient to the cover system (eg heating cables and seal monitoring systems)	Specialized operator	Restoration of function
19	Placement of highly reflective elements that concentrate solar reflection directly on the element sealing	Specialized operator	Opacification and / or shielding of the reflective surfaces, to avoid any deterioration of the seal element. Monitoring and recording of the phenomenon over time
20	Absence localized (for removal) of protective layers or ballasting initially provided	User and / or specialized operator	Repositioning or protective element recovery
21	Presence of potentially aggressive chemical emissions (industrial chimneys or vents on the roof or in the immediate vicinity)	Specialized operator	Possible washing and or the sealing recovery, adoption of suitable measures to prevent the emission and / or sealing element contact with aggressive chemicals

Table 23: Steps to perform

Roofs	Type of error	Relevant norms	Relevant KPIs and value	What to measure?	How to measure	Who is problem owner? Whom to inform?	What is current practice?	How address the problem?	How to prevent error in future?
	Geometric deviations Dimensional incorrectness of prefab element	EN 13670 Execution of concrete structures EN 13369 common rules for precast concrete products	Could be heat transfer	Geometry	e.g. 3D laser scanner, compare with virtual model, sound brush, AR BIM overlay	Manufacturer in factory; if applicable schedule problem; inform project coordinator	Rebuilt or make corrections, if possible	Project coordinator has to clarify with manufacturer and client	Identify cause of error to eliminate it, documentation input to future guideline, check before delivery of elements
	Lack of strength in roof element	EN 1992-1-1 Eurocodes EN 13369 common rules for precast concrete products	Could be heat transfer (humidity, U-value)	Strength of material and construction	e.g. laser scanner, see above	Supplier of construction (new build) or wrong scan of existing situation. Inform project coordinator	Corrective adjustments (strengthen construction)	Clarify with problem owners by project coordinator	Identify cause of error and take corrective steps in earlier stages of building process
	Use of wrong materials or misapplication		Could be heat transfer (humidity, U-value, air leakage)	Thermal performance, acoustic performance	Visual check of right material, number and position	Assembly team. Inform Project coordinator in case of problems	Corrective adjustments	Clarify with assembly team	Identify cause of error and take corrective steps in earlier stages of building process
	Problems with water and vapour resistance layers		Indoor environment (humidity)	Humidity	3D laser scanner and visual check	Assembly team. Inform Project coordinator in case of problems	Corrective actions as early as possible	Clarify with assembly team	Identify and control situation where most problems with water and vapour resistance layer occur

Table 24: Accuracy of roof element – application of tools, measurement needs and expected solutions



The list of identified deviations can then be evaluated by identifying the specifications applicable to deviating products and comparing the requirements imposed by these specifications to the deviations found. If a deviation violates a requirement imposed by a specification, it constitutes a defect. (Piaia et al. 2015 - Chapter 5, Fig. 19 - On-site inspection framework process).

Measurement aspects	Sensors / Measurement Instruments	Measurement Parameters
Thermal transmittance	Thermal Camera, Heat Flux Transducer	U Value [W/m ² K]
Thermal Bridge	Thermal Camera	HD [W/K]
Structural Integrity	Thermal Camera	Thermal contrast [K]
Sound pressure level distribution	MEMS microphone array for Beamforming	Sound pressure level [dB]
Sound intensity field	SoundBrush	Sound intensity level [dB]
Transmission Loss	SoundBrush	TL [dB]
Geometric discrepancy	3D Laser Scanner	Dimension difference [m]
Humidity	3D Laser Scanner	Index of reflectivity L

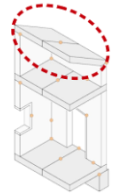
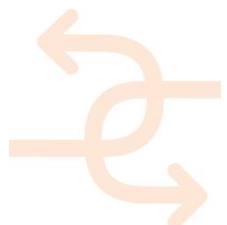
Table 25: From UNIVPM (2016), Par. 2.1 INSITER measurement devices, Table 1: List of sensors for each measurement aspects

6.5 Method to calculate the selected KPIs based on the measured parameters

Since a common mandatory standard for glass curtain wall is not present, the quantification of the related KPIs depends on the energy demands for the building, based on either national building code requirements or voluntary energy protocols (i.e. LEED, BREEAM, Itaca Protocol).

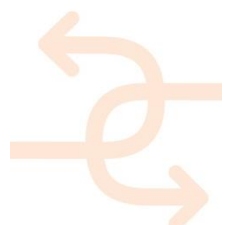

7. Critical EeB component 5: Connection between new and existing buildings

7.1 Strategies overview and installation techniques

Following the EU directives 2010/31/EU⁸ and 2012/27/EU⁹, all Countries have incentivized the energy efficiency refurbishment of the existing buildings.

The main measure adopted include:

- Insulation of the building envelope to improve thermal condition, reduce the U value and to eliminate thermal bridges;
- Upgrading transparent components (doors and windows);
- Improving summer heat protection by adding sunshade devices or increasing the storage mass;
- Enhance natural ventilation;
- Upgrading of the building services¹⁰.

Other retrofitting strategies promote the energy savings and/or density valorisation of the existing buildings using light prefab technologies in:

- Roof-top and building façade addition;
- Roof-top and building façade overlay.

Several EU cases proposed these interventions adopting prefab technologies as wood and steel elements in consideration of the numerous advantages introduced in the following paragraphs. The Appendix 7 of this deliverable propose a short list of EU real cases realized in the last years. The cases were analysed in order to define:

- The most diffuse strategies in the refurbishment interventions;
- The main technologies adopted;
- The main KPIs considered during the process.

In this context, INSITER can help the refurbishment process proposing a new self-inspection and self-instruction protocol to detect and prevent construction errors. This chapter can be considered as a preliminary activity that will be completed with *D1.3 (expected at M36): Guidelines for self-inspection in the refurbishment*.

⁸2010/31/EU: Energy performance of buildings, the directive promotes the energy performance of buildings and building units.

⁹ 2012/27/UE: Building energy efficiency, the directive establishes a common framework of measures for the promotion of energy efficiency within the Union in order to ensure the achievement of the Union's 2020.

¹⁰ Please note, the text does not consider interventions on the building services (MEP-HVAC systems) analysed in the T1.3.

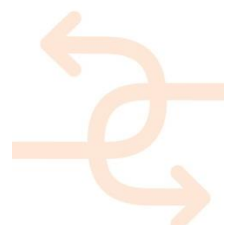

7.1.1 Addition strategy

The 'addition strategy' is defined as: aggregation of new volumes on existing buildings (façade and/or roof) to improve energy efficiency performance and to add new useful spaces on the building or dwelling scale. This strategy uses wood, aluminium, steel or even reinforced plastic technologies in order not to overload the existing structure. Furthermore, these technologies are characterized by more lightness, reversibility and speed construction in comparison of other types of technologies.

Intervention on the building façade:

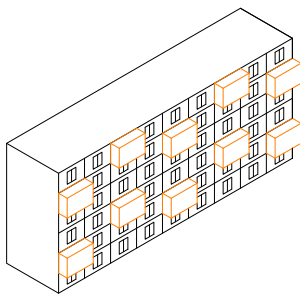

1. New boxes on the building façade are highly dependent from the existing structure of the building. This action proposes new dwelling spaces and improves the quality of the building facade reducing the anonymity and seriality. At the same time this strategy is used to improve the energy performance using the box as greenhouse.

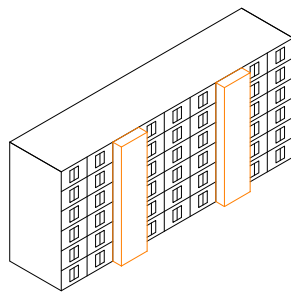

2. New columns on the building façade that are independent from the existing structure. This action is used to add new services (stairs, elevators, MEP-HVAC systems)

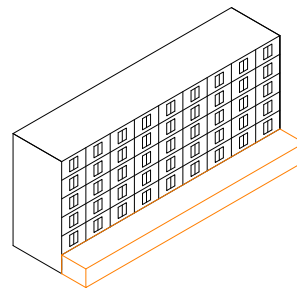

3. New volume on the ground floor. This solution is independent from the existing structure of the building and it is used to integrate new co-functions or public uses/services. The intervention improves the building perception from the street and the energy performance (including greenhouse). This intervention can be proposed on all the building façades.

From the technical point of view, all interventions proposed require great attention to the joint connections between the existing building façade with the new volumes to avoid thermal bridges and air-leakages.

At the same time, it is very important to check the prefab element positioning in order to maintain the structural integration.

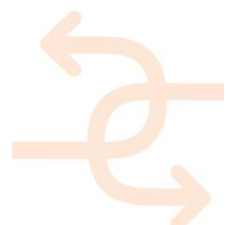

Intervention on the roof top:

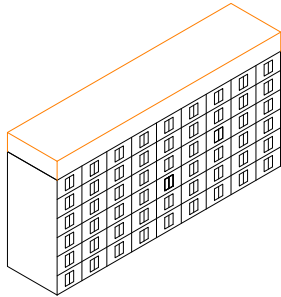

4. The action proposes a new floor, with same shape of the existing building, realized with light prefab technologies. The intervention is highly dependent from the existing structure of the building. Using this strategy is possible: to improve thermal insulation of the building, to install new solar panel, to increase the building density reducing the use of the new ground, to include new dwellings.

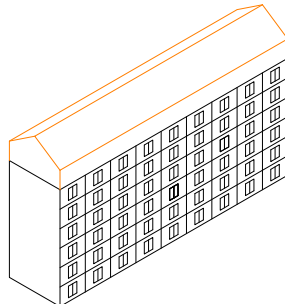

5. The action is very similar to the type 4 but in this case is proposed a new pitched roof. While the solutions of type 4 allow other additions on the roof top, in that case is not possible. The new volume could be realized with shape very different from the existing building.

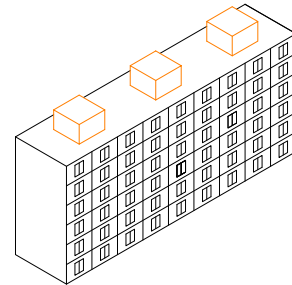

6. Punctual additions on the roof top with new boxes. From the technical point of view is less dependent from the existing building structure in comparison to the solutions 4 and 5. This intervention is used to add on the roof top new special dwellings, new co-functions and or services.

The interventions on the roof top are possible only if the existing building is characterized by flat roof. From the technical point of view, it is important to analyse the structural condition of the existing building in order to reduce static problems due to addition. Like the interventions on the building façade, the control of the joint connections with the existing slab is very important to avoid water infiltration and air leakages.

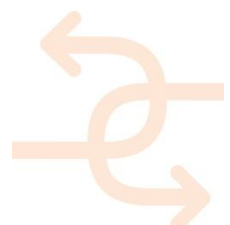

7.1.2 Overlapping strategy

The 'overlapping strategy' changes the quality and/or performance of the building. In comparison to the 'addition strategy' this solution does not propose new volumes but only new layers on the building façade or on the roof. The integration of new components can be accomplished in a best way by application of the prefab system. Three main types of interventions characterize this strategy.

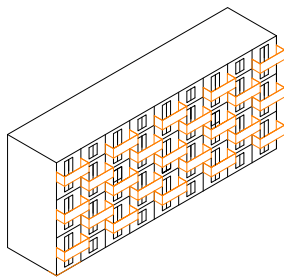

*7. Integration of prefabricated balconies on the building façade.
This action improves the building services with new spaces.
The balconies (realized with steel technologies) are directly connected with the existing building or are positioned on metal brackets and pillars.
Special attention should be paid to thermal bridges and structural assurance during the construction.*

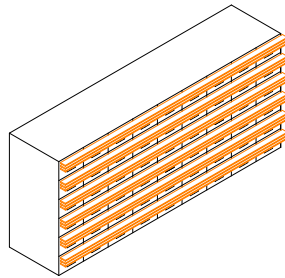

*8. Integration on the building façade of heat protection by adding sunshade devices.
The sunshade can be realized with mix technologies: steel, wood, clay..
In order to obtain the expected results in terms of energy performance and indoor environmental quality it is important to compare the material, dimension and position of the sunshade devices on the construction site with the technical drawings.*

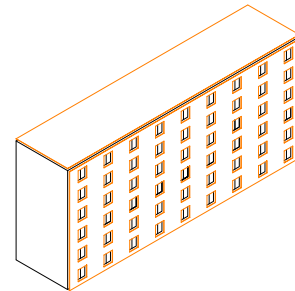

9. To cover the building envelope (roof and building façade) with new layers. The most diffuse solution is the improvement of the thermal condition and U value with the integration of coat insulation. This action can be realized on the building façade and/or on the roof. Before the installation of the insulation it is essential to check the material label. During the realization is important to check the position of the insulation panels and the correct application of the stud for fixing insulation panels. Other technique is the creation of a new ventilating façade realized with panels (wood, metal, clay, laminate) on metal structure.

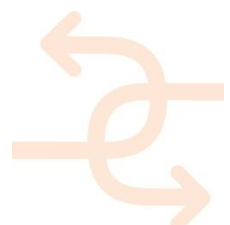

7.2 Installation techniques

The following part introduces important technical aspects concerning the strategies presented; in particular on the joint connection between the existing buildings with the new prefab components.

The connections between new elements and the existing building are relative to the different type of expansion and different type of technologies (wood, steel or prefabricated concrete).

The connections between the building components partly determine the technical quality and the design of the building in particular in terms of structural integrity and energy performance.

In this section we talk about two different cases:

- a. Wood structure expansion (cross-lam panel or lamellar wood);
- b. Steel expansion (post or beam and corrugated metal).

a) Addition with wood systems

The main wood addition technology of existing buildings adopts wood panels called 'cross-lam or x-lam'¹¹. The use of this technology is a diffuse solution for building floor expansion or rehabilitation in consideration of lightweight and the limited additional dead load transmitted to the existing structure.

The wooden panels are normally connected to the loadbearing structure with steel plates and bolts.

Generally, the wood panel's connections can be divided in three categories:

- 1) Connection between vertical panel and horizontal panel;
- 2) Connection between vertical panel and vertical panel;
- 3) Connection between horizontal panel and horizontal panel.

In all three cases it is important to ensure the transmission of loads from one element to the other and to ensure the strength of the junctions regarding external actions (rain, wind and seismic waves). In order to connect two different panels, the special corner elements are often used, called "hold-down" junctions.

The connection between wood elements can be divided in two categories:

- 1) 'Traditional unions' of the wooden carpentry realized through the processing of the contact surfaces (carpentry joint);
- 2) 'Mechanical joints' of the modern type, in which the transmission of forces takes place not directly, but through the insertion of metal elements or layers of glue (mechanical joint). The most common joints used in the expansion of existing building are the mechanical joints¹².

From the energy performance point of view, the x-lam panels are usually covered: 'externally with a coat-insulation fixed with special plugs and finalized with plaster; internally it is completed with a dry-wall construction.

¹¹x-lam is an innovative, safe and dynamic construction system that uses wooden panels to realise walls, floors and partitions for all types of structure (new buildings and refurbishment interventions). The x-lam panels consist of at least three layers of boards in wood, mutually intersected and glued. Referee UNI EN 1995-1-1.

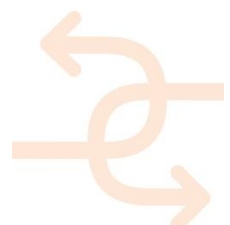

To evaluate the 'energy efficiency' and the 'indoor environmental quality' of the refurbishment interventions with wood technologies (x-lam) it is very important to avoid the following construction errors:

'Incorrect or mistaken assembling of the building components':

- 1) The dissipative zones should be located at the nodes and connections;
- 2) Incorrect hold-down placement;
- 3) Respect of the design tolerances of the metal plates;
- 4) Incorrect positioning of the wooden panels.

'Improper elements installations':

5) to check the conformity of the elements through the label (CE marking) and Technical Suitability Certificate to evaluate the material characteristics (moisture, resistance) before the installation. Despite this it is necessary to control on-site other detail aspects:

- 6) the dimension of the wood knots (according to a specific tolerance that is accepted);
- 7) the finger-joint of the lamellar structure (the law prescribes a specific distance between the node and finger joint);
- 8) delamination of some of the layers that make up the panel.

'Incorrect stocking of the elements on-site' and 'incorrect protection of the wood panel after the assembling':

9) to protect the wood panels from rain, snow or improper human actions.

b) Addition with steel systems

The expansions of existing buildings made through the use of steel elements are those that present the best balance between weight of the structure and mechanical strength to the efforts-

Generally, the connections of the steel elements can be grouped into two categories:

1. Fixed connections:

- a. *Rivets*¹³;
- b. *Welding*¹⁴;

2. Demountable connections

Demountable connections are the most common connections in the building industry. The advantages of steel demountable connections are: the ability to control the quality of the union with mechanical tools (torque wrench), the possibility to change the damaged union without changing the whole structural element; the possibility to dismantling the union. Normally the demountable union are made with 'bolts'.

The connection of the steel system with the existing building can be realized as follows:

Steel connection plates are concreted into the walls of the concrete core. The webs of the steel beams are subsequently screwed to these plates with bolts.

¹³Rivets connections are almost exclusively used in the area of listed or protected buildings or for repair work to riveted historical constructions. This method is both labour intensive and uneconomical. In the classic riveting method, the white-hot glowing rivet is taken out of the riveting oven, descaled with a wire brush and placed in the rivethole.

¹⁴Steel building elements, can be connected by electric arc-welding or gas welding. Welding techniques can be divided into hand welding or automatic welding.

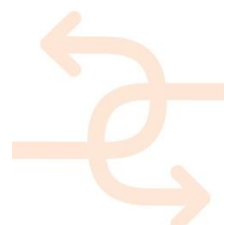

A steel connection plate is set flush in the concrete wall and anchored. Connecting elements can then be welded to this connection plate.

The concrete wall is cast with recesses in which steel bearing plates can be inserted and anchored to the concrete. The steel beams are then set into the recesses and fixed to the wall by screwing the flange of the steel beam to the steel bearing plate.

c) Addition of prefab multifunctional panels on building façade

The market proposes several examples of innovative prefab multifunctional panels available to improve the existing building envelope in terms of: architectonic quality and energy efficiency. For example, existing insulated panels and/or specific panels for ventilated façades that allow reducing also the installation time in comparison to the traditional retrofitting. In consideration of these typologies there are two main technical applications:

1. Directly attached on the existing surface creating a new building envelope where it is very important to control, on-site, the surface integrity and the joints connection between the different panels. The P2Endure research project, also coordinated by DEMO, tests these solutions in the retrofit interventions proposing the EASEE prefab panels. The EASEE panel is composed of two layers of textile reinforced concrete (12 cm) and insulation core between them made of expanded polystyrene (10 cm).
2. Assembling of the panels using a substructure realized in metal or wood which is fixed with specific plugs on the existing building. This option is typical of the ventilated façade where the external panels can be in several materials (wood, laminate, metal, concrete, aluminium, glass, and ceramics). The ventilated facade is usually adopted in the refurbishment interventions because it offers a high level of aesthetic characteristics and advantages of heat insulation and soundproofing. In terms of thermal energy, the ventilated facades can reduce the amount of heat that buildings absorb in hot weather conditions. Vice versa, in winter, ventilated walls manage to retain heat, resulting in savings in terms of heating. Also, this building system, allows setting up efficient natural ventilation, guaranteeing a high level of living comfort.

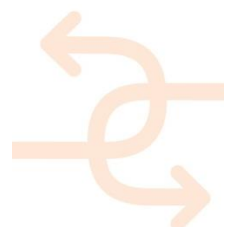

7.3 Relevant KPIs

The new EU and National directives demand specific requirements on the existing buildings refurbished in terms of energy efficiency. This condition is a must to obtain the building licence and it is necessary to receive economic incentives.

Regarding the building components, the U-value is the most important. In fact, the directives require limit value in consideration of the building elements (roofs, walls, ground floors, and windows), building function and climatic zone. For this reason, in order to improve the building energy efficiency in the refurbishment context it is very important to control the 'building envelopes heat transfer and consequently the thermal transmittance.

Thermal transmittance

The envelope's thermal transmittance is relevant since during the refurbishment it is necessary to reduce this value in comparison to the existing condition. In order to measure the thermal transmittance it is necessary to calculate the 'U value' [W/m^2K] following the analytical methods presented in the EU norms (see also D5.1 and D2.3):

- EN ISO 7345: Thermal insulation - Definition of the thermal transmittance of a building element (U-value);
- EN ISO 6946: Building components and building elements. Thermal resistance and thermal transmittance. Calculation method (walls and roofs);
- EN ISO 10077: Thermal performance of windows, doors and shutters. Calculation of thermal transmittance;
- EN ISO 13370: Thermal performance of buildings. Heat transfer via ground. Calculation methods.

It is important to underline that these methods do not consider the correct installation (*in-situ*) of the envelope elements and components (included insulation material). There is another important EU norm that proposed in-situ measurements using specific apparatus (tools): ISO 9869-1 (Thermal insulation – Building elements – *In-situ* measurement of thermal resistance and thermal transmittance).

The ISO 9869-1 describes the 'heat flow meter method' for the measurement of the thermal transmission properties of plane building components, primarily consisting of opaque layers' perpendicular to the heat flow and having no significant lateral heat flow. Furthermore, the norm introduces the tools to be used, the tools calibration procedure, the installation and the measurement procedures, the analysis of the data, including the correction of systematic errors and the reporting format.

Generally, *in-situ* thermal transmittance measurements are most accurate when:

- The difference in temperature between the inside and outside of the building is at least 5 °C;
- The weather is cloudy rather than sunny (this makes accurate measurement of temperature easier);
- There is good thermal contact between the heat flux meter and the wall or roof being tested;
- The monitoring of heat flow and temperatures is carried out over at least 72 hours;
- Different spots on a building element are measured or a thermographic camera is used to secure the homogeneity of the building element.

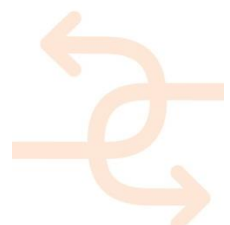

Two main 'tools' are used to inspect the thermal transmittance *in-situ* and measure the real 'U-value':

1. Thermal camera (Thermography investigation)

Thermal imaging cameras are improving the knowledge regarding infrared measurements. The devices today are smaller, higher portability, easier to use and cheaper. With thermal imaging cameras it is easiest and quickest to detect energy waste, moisture and electrical issues in buildings. Thermal imaging cameras show exactly where the problems are located (poor or inadequate insulation, moisture, building envelope leaks). Thermal imaging cameras can help you quickly to detect places where energy efficiency can be improved.

2. Heat Flux Sensor (Heat Flow meter methods with Heat flow meter transducer and Temperature sensors)

A heat flux sensor is a transducer that generates an electrical signal proportional to the total heat rate applied to the surface of the sensor. It is used to study the building envelope thermal resistance. The total heat flux is composed of a conductive, convective and radiative part. Depending on the application, one might want to measure all three of these quantities or single one out.

7.4 Quantifying KPIs (on-site)

Analysing the main relevant technical norms for building assessment introduced in PIAIA, ET. AL. 2015 and in according with the EU Energy Directive (2010/31/EU – Energy Performance of Buildings Directives), this sections presents:

- The average or range value to assess the KPIs;
- The main procedure to quantifying the KPIs;
- How the data will be processed (self-instruction and self-inspection procedure).

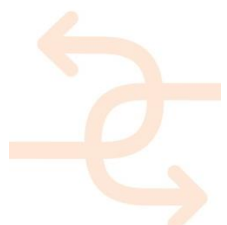

The average or range value to assess the KPIs (see also D5.1 and D3.2)

The section presents the procedure to quantifying KPIs in accordance with the contents of Piaia, et. al., 2015 and in accordance with the EU Energy Directive. The KPIs selected for this section is the Thermal transmittance as defined by the ISO 9869 (Thermal insulation - Building elements - in-situ measurement of thermal resistance and thermal transmittance).

The ISO 9869 defines the thermal transmittance of a building element as the heat flow rate in the steady-state divided by area and by the temperature difference between the surroundings on each side of a system, the thermal transmittance is indicated with the symbol U , and the unit of measurement is W/m^2K .

The International Standard define that thermal transmittance can be measured only if the site is in steady-state conditions, otherwise the measurement is not possible. The method to measure the thermal transmittance is the 'Heat flow meter method' (HFM). The HFM is a transducer giving an electrical signal which is a direct function of the heat flow transmitted through it. The HFM instruments can be used to measure the thermal performance of rigid and higher thermal conductivity (lower thermal resistance) masonry products such as concrete, gypsum board, stone, lumber. The measurement of thermal insulation also concerns the geometry of the buildings themselves and the related thermal bridges in addition to the transmittance value of the individual walls or glass surfaces that make up the outer shell of the building. Heat flux measurements are needed to gain a better know ledge of the thermal performance of buildings and to evaluate the heat exchange among various parts of a building envelope. Heat flux meters (HFMs) are commonly used both in laboratory applications and *in situ* for measuring one-dimensional heat flux sand, thus, estimating the thermal transmittance of material samples and existing buildings components (Arpino et al., 2011¹⁵).

For HFM methods, careful sample preparation and special techniques may be required to obtain accurate surface temperature measurements. The mentioned building materials may have rough surfaces and therefore preparation of samples with highly flat and parallel surfaces is a challenging task. This may result in a considerable interface thermal resistance in any air gaps between the sample surfaces and instrument plates. If this thermal resistance is higher than the thermal resistance of the sample, then temperature sensors mounted in the plate surface become ineffective to measure the temperature difference throughout the sample. Through the HFM methods we can measure two different properties:

- 1) The thermal resistance R (m^2K/W), and consequently the thermal conductance A ($W/(m^2K)$), from surface to surface;
- 2) The total thermal resistance, R_t (m^2K/W), and the transmittance from environment to environment U^{16} ($W/(m^2K)$).

If we want to calculate the heat flow of a building there are three factors which can determine it. The three factors are: the temperature differential; the area of the building exposed, and the heat transmission value of the exposed area.

Thus, the use of a suitable thermal mass and thermal insulation is very important for controlling the heat flow and energy conservation in buildings. The components of a building envelope respond "dynamically" to changing ambient conditions (Ahmad et al., 2014). For this reason, and to obtain a true result the measurement of the Thermal transmittance can be made with two different methods, both explained in the ISO 9869. The methods are:

1. The average method (simple method);
2. The dynamic method (more sophisticated method and more quality result).

¹⁵ Arpino et.al. 2011, Design of a Calibration System for Heat Flux Meters, in International Journal of Thermophysics, December 2011, Volume 32, Issue 11, pp 2727–2734, DOI: 10.1007/s10765-011-1054-3.

¹⁶ This value can be calculated only if the environmental temperature of the environments is well defined.

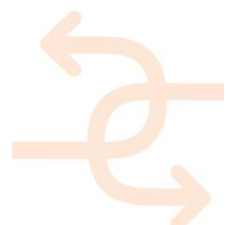

It is important to remember that conventional steady-state thermal conductivity measurement techniques like the heat flow meter are simple and easy to use but have been limited to certain ranges of the spectrum of thermal conductivity, often require specific geometries for testing, and even minor heat losses can significantly influence accuracy. In contrast, new techniques, such as laser-flash or transient hot-strip, are known to be reliable over the entire range but conductivity measurements typically involve relatively complicated data analysis and are contingent upon the accurate determination of specific heat capacity and density. Additionally, most conventional techniques, namely laser-flash or three-omega, may only provide an effective thermal conductivity when used for characterizing materials with anisotropic thermal properties unless modifications are applied (Nayandeep et al., 2010¹⁷).

¹⁷ Nayandeep et al., 2010, The dual-mode heat flow meter technique: A versatile method for characterizing thermal conductivity, in International Journal of Heat and Mass Transfer, November 2010, Volume 53, Issues 23–24, Pages 5581–5586.

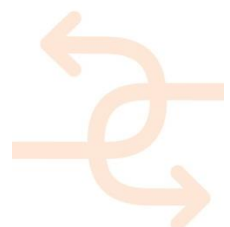

The average method

This method assumes that the conductance or transmittance can be obtained by dividing the mean density of heat flow rate by the mean temperature difference, the average being taken over a long enough period of time. Given the dynamism of the thermal transmittance to obtain a corrected value it is necessary to meet three conditions:

1. The heat content of the element will be the same at the end and at the beginning of the measurement;
2. The HFM will not be exposed to direct solar radiation (if we measure the thermal transmittance and there is solar radiation on the exterior surface, a false result could be obtained);
3. The thermal conductance of the element must be constant during the test.

The dynamic method

The dynamic analysis method is more complicated than the average method, and it is used when large variations of temperature and heat flow rates occur. The measurement of the thermal transmittance is obtained using the heat equations, and evaluating different densities of heat flow rates. The duration of the dynamic analysis method require more duration in comparison with the average method. However, the test duration is 72 hours minimum, in some cases, it requires 7 days.

Data acquisition procedure

The procedures to obtain data using the HFM method are various. In the International Standard (ISO 9869), the main important step of the data acquisition are described. The most important thing is that the HFM must have a low thermal resistance to minimize the perturbation caused by the HFM and a high enough sensitivity to give a sufficiently large signal for the lowest heat flow rates measured.

For data acquisition it is necessary to use: temperature sensors, heat flux sensors and thermocouples, moreover it is necessary to have a thermo-camera to identify the right position of different sensors, to avoid false measurement. If, for example, we want to measure the thermal transmittance of a building wall, we have to put both on the exterior and interior walls the thermocouples and the interior walls must be instrumented with heat flux sensors. Furthermore, both on the inside and the outside walls, the temperature sensors must be installed. The locations for placement of heat flux sensors were determined using an infrared thermographic camera to avoid the areas with thermal leakage.

"Environmental temperature sensors shall be chosen according to the temperature to be measured. If the U-value is defined by the ratio of density of heat flow rate to the air temperature difference, air temperature sensors are to be used. These sensors are shielded against solar and thermal radiation and are ventilated" (ISO 9869). Sensors shall be mounted in such a way so as to ensure a result which is representative for the whole element.

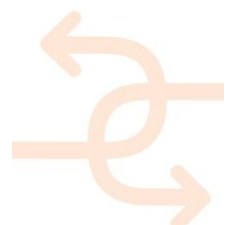

There are some conditions that HFM test have to respect to obtain a true measurement, and so to have a real U-value.

The conditions are:

1. The HFM shall not be installed near thermal bridges, cracks or similar source of error;
2. The sensors shall be installed in a representative area of the wall that we want to describe (not along the edges);
3. Apply the thermometers in two different points of the inner face of the wall;
4. Apply the thermometers in points corresponding approximately to the outer face of the wall. The sensors must adhere perfectly to the wall;
5. The sensors shall not be under the direct influence of a heating or cooling device, or near the draught of a fan;
6. Verify the absence of anomalies inside the wall in the measurement zone;
7. The exterior walls of the building should be protected from rain, snow, and direct solar radiation;
8. To obtain a representative average of thermal transmittance it is necessary to use many HFM sensors;
9. The temperature sensors and the HFM must be of the same colour and emissivity (this is important for the sensors exposed to the sunlight);
10. To minimize measurements errors perform the experiments during a season in which there is a large temperature differences between inside and outside environment;
11. Make sure that between the sensors and the wall surfaces there is a good thermal contact;
12. Possibly choose a wall facing north.

7.5 Preliminary 'self-inspection procedures' in the refurbishment process

In the refurbishment process in order to avoid error in the building construction, different tools and software are available. It is also important to establish when this "instruments" have to be utilized. It is important to define the phases within the building process in which those tools must be used and how the operators/workers can evaluate different measurement aspects. The self-inspection procedure is necessary to reduce or eliminate the gap between the performance established during the design phases and the real value for each measurement aspect.

The Piaia, et. al., 2015 describes the phases of building process from the concept phase (1°) to the maintenance and use (9°). This section show how the KPIs can be evaluated in each phase and the procedures to measure different measurement aspects during different main stages of the process. The following text illustrates the methods of evaluation and measurement of a single KPI in order to define, through the example of the thermal transmittance, a repeatable process for the other KPI studied by INSITER.

The most important parameters to determine the level of energy efficient building (EeB) is the U-value that is proposed as example in this section. The thermal transmittance is also selected because it is defined both at international and national level, in fact the ISO 9869 describes the official procedure for the calculation of the thermal transmittance, calibrate the sensor and for data management. Thanks to this information (shared at European level) the self-inspection procedures elaborated by INSITER in the refurbishment process can be shared and compared at European level.

The thermal transmittance of a building 'in-situ' can be measured when all of its part are completed. Indeed, to evaluate the heat flow is necessary a difference in temperature between the inside and outside of the building at least 5 °C.

However, it is possible to define the self-inspection procedures to verify the correspondence between the real value of the thermal transmittance and the one established during the design phase, this can be done using different tools and software that will be described in the following paragraphs.

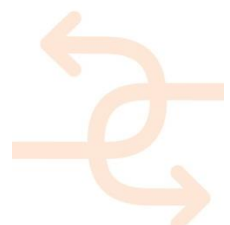

Existing building assessment

To proceed to the design of an existing building refurbishment it is necessary to know the real level of performance of the existing building and of its envelope. It is necessary to know both physical characteristics and the energy performance level of the existing envelope. It is necessary to know the real value of thermal transmittance of the envelope to understand which type of refurbishment is necessary to achieve the performance levels set by legislation.

The real transmittance value can be evaluated with different methods:

- 1) Read the project technical reports, if they exist;
- 2) Define the envelope performance level referred to the UNI-EN-ISO table, through hypothesis about the composition of the envelope to know the stratigraphy of external wall;
- 3) Detailed evaluation through the in-situ measurements using a heat flow meter (HFM in-situ).

The data obtained from the existing envelope analysis must be imported in the BIM model, to process alternative intervention scenarios in the next stage of the building process.

Design phase

During the design phase (concept design - detailed design - final design) it is possible to decide the level of thermal transmittance of materials to be used in the building envelope according to the requirements for the refurbished building. To determine the value of the thermal transmittance of a material in the design phase it is necessary to determine both the quality of the material and the thickness of the elements to be used to reach the desired value.

In the design phase the measurement of the transmittance is mainly processed through the use of software. To obtain a theoretical value of transmittance during the design stage it is therefore necessary to include the technical specifications (density, chemical composition, thickness, porosity) of the materials chosen in the software. After entering the data in the software, the software can process the transmittance value of the project wall. Usually the calculation of the thermal transmittance is matched with the calculation of Glaser, to control the interstitial and surfaces condense. The results obtained with the "design stage analysis" can then be put into the BIM model which becomes an instrument of control for the phase of "production factory" and "on-site assembly."

The thermal transmittance can be calculated thanks to the use of software used for processing the 3D model, such as Revit and ArchiCAD. During the design phase the thermal transmittance can be calculated thanks to the use of software used for processing the 3D model, such as Revit and ArchiCAD. These software applications include specific tools for the evaluation of the thermal transmittance.

During this phase the thermal transmittance of each component or element can be calculated following the international regulations (EN ISO 7345; EN ISO 6946; EN ISO 10077; EN ISO 13370). In particular, to calculate the U-value of a single material a Hot Box Heat Flow Meter method (ISO 8990) can be used.

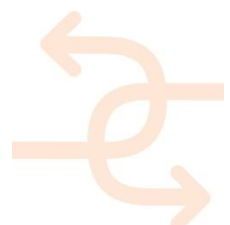

Pre-production - factory production

The pre-production and the factory production tasks are the stages in which all the prefabricated components are studied and are constructible combining the final design requirements with the technical knowledge of the construction industry (Piaia, et. al., 2015). Even now during this phase, it is possible to evaluate only some of the measurement aspects described in the previous deliverables, regarding the thermal transmittance it is not possible to calculate the real value. To ensure the performance level of the components established in the design phase you must check the quality of the materials used for the production of elements and components. In these phases, for example, to ensure the thermal transmittance value of the insulation will be necessary to check the density of the material, the coefficients of thermal conductivity. When the materials become products it is possible to make preliminary checks to ensure that the product will be delivered to the building site having the characteristics set out in the design phase. The described data can be more easily analysed using BIM software (please note that it is only possible if the information has been entered correctly using the right attribute. It is always a requirement to prepare the BIM models correctly to be able to access all entered information properly). During the factory production phase the producers perform laboratory tests on samples of material in order to ensure the real performance of the component. To verify the transmittance normally used method is the HFM Hot Box method. The measurement is performed by placing a sample of the material to test between two metal plates, (hot and cold plates). The used software measures the transmittance through the material every 15 minutes, preparing a graph illustrating the performance level of the material when this is crossed by a flow of heat.

On-site assembly

During this stage, the building is assembled “on-site” in accordance with the Construction Programme (Piaia, et. al., 2015). To ensure that the prefabricated components used in the construction meet the requirements laid down in the previous steps must the control of the geometry (length, width, thickness, area, weight) must be carried out and the correct positioning of the elements. The final value of the transmittance of the building is closely related to the assembly of prefabricated components, for this reason before assembling the various elements of the construction it is necessary to perform the dimensional congruence of various components in respect to the requirements set in the project and also to the realized BIM model. After checking the dimensional congruence of the components it is important to test the surface quality of the elements to ensure integrity and then the level of performance of each single element (this type of inspection can also be conducted with visual inspection). To control the geometry and the correct positioning of the elements, different methods can be used: visual inspection (surface quality), laser scanner and related software inspection (positioning of elements), dimensional measurement inspection.

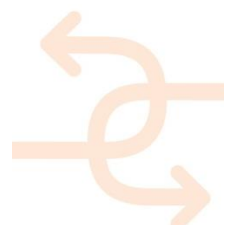

Commissioning - use and maintenance

The commissioning stage ensures and confirms the building performance/quality in comparison to the expected requirements. The commissioning process is the process for achieving, validating and documenting that the performance of the total building and its systems meet the design intent and requirements of the owner. At this stage it is possible to accurately assess the compliance of the actual KPIs with those established in the design phase. When the building is completed it is possible to calculate the value of in-situ thermal transmittance using the method described in § 1.3. With a Heat flow meter transducer and thermal sensor it is possible to calculate the heat flow throughout the wall and so calculate the real *U-value*. In the commissioning and use - maintenance phases it is possible to comprehensively assess the level of energy performance of the building through the use of various software. The software Simaxx-Monavisa is able to evaluate the energy performance of the building during everyday use, "the Monavisa software gives your building a "voice" that tells you what goes wrong and what will lead to complaints or unnecessary cost" (<http://www.simaxx.com/en/>). With Monavisa that checks the proper functioning of the building, it is possible to estimate how much the forecasts made during the design phase correspond to the level of real energy efficiency of the building constructed.

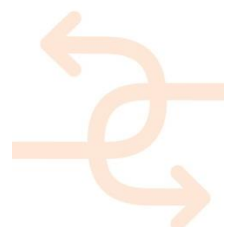

7.6 Testing on demonstration cases

The technical monitoring of the U-value using the tools introduced in the previous paragraphs is completed at the lab of the University of Politecnica delle Marche (see also D5.2). The next step is the evaluation on the real demonstration cases. INSITER proposes 5 demonstration cases, two of these cases concerns important refurbishment interventions. In particular the existing Health Care Centre in Cologne will be extended in the next year on top of the 3rd storey. The construction of the extension will adopt a lightweight construction of either steel or timber. It will be assembled on site with prefab elements. The interior walls will not be bearing walls and therefore will be flexible in terms of possibly changing future uses. The building envelope and the used HVAC systems will be highly qualified in terms of energy efficiency and be in line with the German building law.

In consideration of this short introduction, this demonstration case is perfect to test the INSITER methodology, including test of the U value inspection in several stages of the process starting with the creation of a BIM parametric model of the existing situation. The parameters to consider in the model are: technical information, thickness, density, porosity, of the building envelope layers; building orientation (north, south, south-west) and climatic zone.

The interest of this building is related to the fact that it has large reproduction possibilities.

KPI addressed	Critical EeB issue addressed	Affected building components	Description of self-inspection method in this report	Description of KPI calculation method in this report	Remarks or limitations	When is this KPI relevant?
Energy efficiency: thermal transmittance	Performance of the building envelope. Thermal bridge due to discontinuities or gaps in the insulation material.	Roof Components (e.g.: galvanized steel sheet, PVC cover, structural elements, insulation material, fibre cement ceiling or plasterboard, skylight) Building façade Components (e.g.: Prefab panel insulated, structural elements, additional insulation panels; skin elements; plasterboard, windows)	Ch. 7, Sub 7.5, Page 118	Ch. 7, Sub 7.4, Page 114	The thermal transmittance of a building 'in-situ' can be measured when all of its part are completed; It is necessary a difference in temperature between the inside and outside of the building at least 5 °C, to evaluate the real heat flow.	This KPI is relevant both during the on-site assembly (correct positioning of the elements) and during commissioning and use phase, because it (KPI) can determine the energy performance level of the building envelope

Table 26: addressed KPIs regarding connection between new and existing building

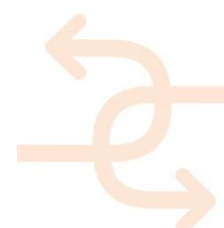

8. Conclusions

8.1 Key findings

Having analysed joints of different building components, the relevant KPIs measurement aspects and their relation to the most frequently made errors during the construction process, it became obvious that geometric accuracy and the ways that the joints and connecting elements are treated is the most crucial measurement aspect that affects all KPIs that are relevant for energy performance of the buildings. In that respect in Chapter 3, a strategy is worked out how to calculate geometric accuracy. During construction phase, measurement instruments as proposed by Revel, et. al. (2016) are relevant to this work. In Chapter 4 ultrasound technology can be applied to test on-site the air leakage. The measurement procedure consists of a scanning over the area under test with the ultrasonic detector which won't receive any signal if the envelop is completely sealed, and will detect the ultrasonic wave passing through the crack if a defect is present in the ultrasonic wave path.

This means that with the tables that 3L provides it is possible to write the measured value and later to check against the norm. UNIVPM developed methodology and tested the instruments that can be used for measurement of other KPIs.

The instruments that were tested by UNIVPM, together with BIM/AR can be used on a construction site to ensure geometry accuracy during the construction process.

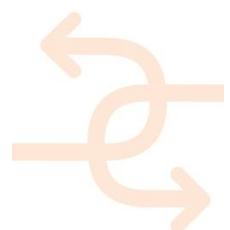

8.2 Generalization, extension and applicability of the methodology

The INSITER methodology of quality assurance is following the specific needs at different phases of the building process in order to develop matching analysis and calculation methods. The methodology is transferable and not dependent on material choice, factory level qualification or national legal requirements. The INSITER tool will be adjustable to national or local needs representing a list of KPIs and addicted threshold customizable by the user.

The INSITER proposes a new methodology and tools which go beyond current practice with a focus on:

- 1) Intervening on time by
 - a) improving communication and reporting of observed error on site and therefore also
 - b) accelerating decision making process and c) reducing pre-commissioning and commissioning phase significantly
- 2) Reducing construction costs of a building since the mounting and testing of one-on-one model does not need to be done in the factory but can be done directly on site. This is a practice in Germany but not in the Netherlands. Only for very large buildings there are in the Netherlands the mock-ups to test one-on-one.
- 3) In Piaia, et. al., 2015 in Fig. 22 a protocol feedback loop is introduced in order to make sure that project knowledge evolves continuously by providing direct feedback to design phase in order to adjust design, rather than to conduct on each relevant building component a significant adjustment on site. This is communicated to the production phase in order to adjust the production line. This figure is actually a quality assurance during the construction process and enabling at the same time evolving of the project knowledge by signalling and communicating potential errors which may have significant impact on a whole construction project. For a KPI to work optimally, all parties that are responsible for that KPI should also have a control over its quality as to be able to take ownership of the achieved results and continuously work on the improvements, by recognizing what works well and what doesn't and applying evidence based approach whenever a change is initiated, by measuring the base line and the effect of the change on a total building performance.
- 4) Greatest advantage of the INSITER methodology is to get rid of analogue protocols as much as possible. Thanks to a laser scan it is possible to overlay the actual site construction with the BIM model. In a case of retrofitting or extension, this means that additional time and energy is required to conduct laser scan measurements and transform relevant information into BIM model.

On certain areas INSITERS KPIs may look the same but they are on another level and having done the analysis of different KPIs it became clear that the KPIs that are measured once a building is finalized cannot be also measured during the construction process. The KPIs are defined as a set of quantifiable measures used to measure building performance over time. In order to precisely calculate these KPIs a closed structure is required. Whether this is possible, depends greatly on the complexity of the building and the construction process.

The results of deliverable 2.3 chapter 4 are complimentary work to this deliverable as ultrasound technology can be used for air-leakage detection. Ultrasound technology is an efficient system for leak detection in the sector of pipelines and transmission lines but it is also applicable for a chosen 'joint' approach that is introduced in the chapter 2.

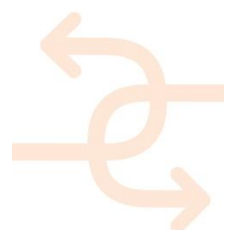

This methodology is applicable to all sectors of the AEC industry and can help:

- Reduce the amount of errors during construction phase;
- Provide a logical feedback to other phases and also collect information from later stages of design (the loop) so that there is a natural evolution of knowledge within different layers and actors in the project;
- Enables producers to anticipate in early stages of development and signal possible challenges;
- Enables faster communication between the partners and the recording of on-site deficiencies so that they can be solved on time;
- Those who are end-responsible for a particular KPI can be empowered with the technology that will support them in conducting their work as good as possible and at the same time being able to correct their work early in the construction process. The INSITER methodology enables the construction worker to take the ownership of the work that they are conducting;
- Will reduce the commissioning process thanks to the supportive technology layer that is enabling self-inspection and self-instruction.

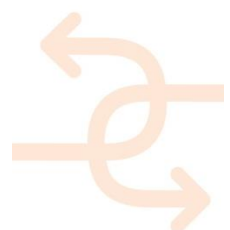

References

Arcelor Mittal, Peiner Träger and Corus – Steel buildings in Europe - Multi-Storey Steel Buildings Part 1:Architect's Guide (framework of the European project “Facilitating the market development for sections in industrial halls and low rise buildings (SECHALO) RFS2-CT-2008-0030”.

Arpino et.al. 2011, Design of a Calibration System for Heat Flux Meters, in International Journal of Thermophysics, December 2011, Volume 32, Issue 11, pp 2727–2734, DOI: 10.1007/s10765-011-1054-3.

ASHRAE 2010 Project Committee Manual of Practice (PC MOP)

EN 13369 - Common rules for precast concrete products

EN 13670 - Execution of concrete structures

Marco Pio Lauriola (2012) - Timber Construction.

Matteo Fiori (2015) - TiSCO group Politecnico di Milano - The project of the continuous roofing.

Nayandeep et al., 2010, The dual-mode heat flow meter technique: A versatile method for characterizing thermal conductivity, in International Journal of Heat and Mass Transfer, November 2010, Volume 53, Issues 23–24, Pages 5581–5586.

NIBS Guideline 3-2012 Building Enclosure Commissioning Process BECx This Guideline is for Use with ASHRAE Guideline 0-2005: The Commissioning Process, 2012

Piaia, E., et al. (2015) – INSITER Best practices and existing shortcomings

Revel, G.M., et. al. (2016) – INSITER Toolset of capturing, measurement and diagnostic systems for self-inspection, Deliverable 2.3

UNI 11345:2010 - Control activities for the design phases, execution and continuous roofing management.

UNI 11540:2014 - Guideline for the drafting and right implementation of the maintenance program of continuous roofing made with flexible sheets for waterproofing.

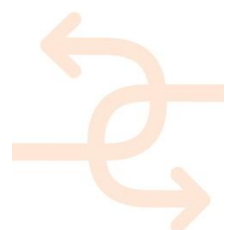

APPENDIX 1 – Principles of prefab construction and foundation

Principles of prefab construction systems in housing and their influence on foundation design and construction

Light-frame construction as
Balloon or
Platform frame
Slab construction (Plattenbau)
Modular construction
Combined and cross-over constructions

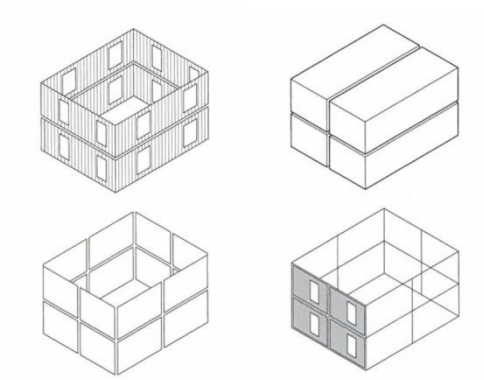

The structural shape of the foundation is following regularly the linear introduction of forces into the building ground. The practical solution is the strip foundation poured on site or precast.

Principles of prefab construction systems in industrial buildings and their influence on foundation design and construction

Ultra-lightweight (e.g. tents)
Modular
Steel skeleton
Concrete/steel skeleton
Concrete skeleton

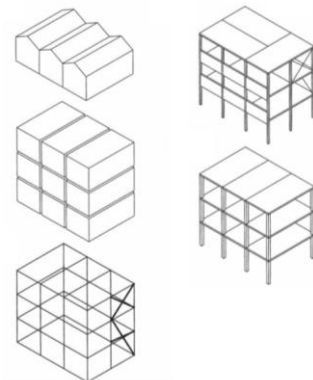

The structural shape of the foundation is following the linear introduction of forces into the building ground, too. The demand of extra floors and extra loads is just influencing the shape and other dimensions. The practical solution is the strip foundation poured on site or precast. The precast alternative is often used as the repetition frequency is economically interesting.

Principles of foundation

- a. Ground floor on pad footing
- b. Ground floor on strip foundation
- c. Ground floor on foundation slab in situ

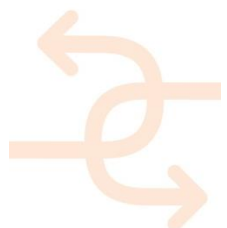

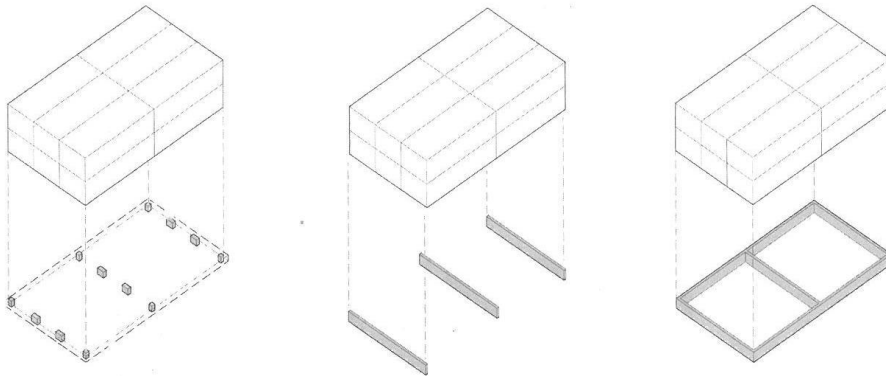

Types of ground floor constructions

The construction of the ground floor (at ground floor level) is very similar to the construction of a regular floor slab between two heated areas. Since it functions as a part of the building envelope it has to fulfil other or additional requirements regarding airtightness (especially to prevent entering of dangerous gasses like radon in the building. To prevent entering of the humid air from the crawl space entering in de void between the inside and outside leaf of the façade, moisture resistance, heat insulation, sound insulation, fire security, corrosion.

The larger prefabricated concrete slab (a) requires less on-site time and has fewer connections, the prefabricated concrete plank floor (b) is less cumbersome during transportation and erection but is still structurally sound, while prefabricated concrete structural decking (c) and prefabricated panels (d) offer the most flexibility in planning.

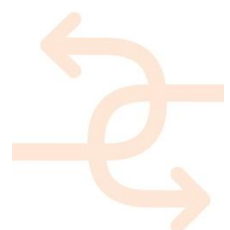
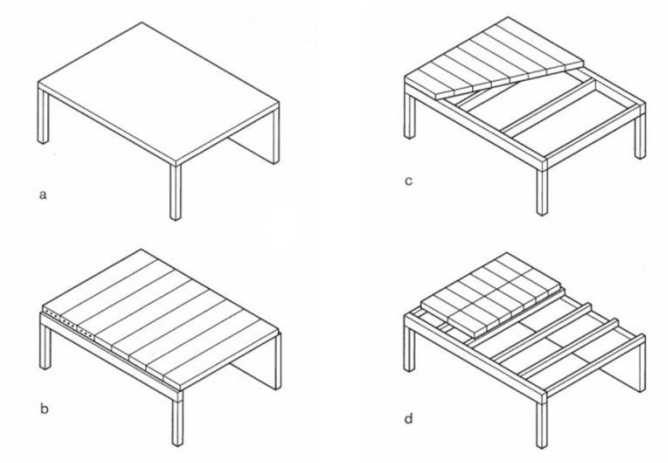

APPENDIX 2 – Examples of differences of foundation and ground floor per country

The section above shows the characteristics of the points of junction at the 3D scheme in detail. This is an example from Germany. The foundation is built as a strip funding. The building envelope consists of a wooden structure of floor and wall prefab panels. Quite often and related to country characteristics the funding will be done as a slab foundation. The difference is just the fixing of the floor or the wall panel as the first element mounted on the concrete.

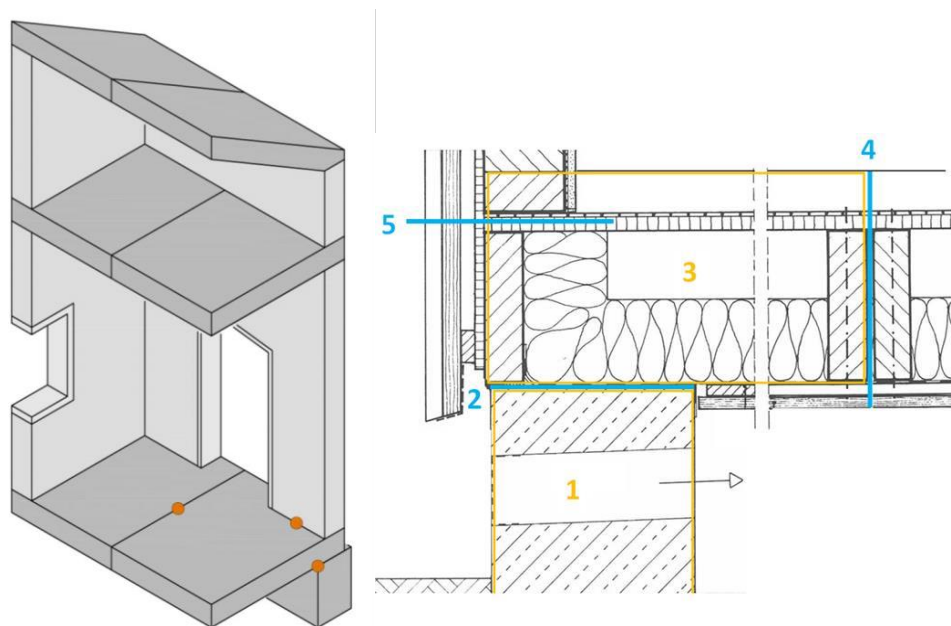
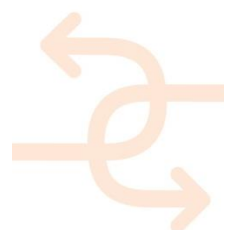

Figure 1: An example from Germany

The way of foundation and ground floor might differ between countries.

A common situation in the Netherlands is:

- Ground beam (on foundation piers);
- Prefabricated floor element (in this case a ribbed-slab floor);
- Covering floor (in-situ).



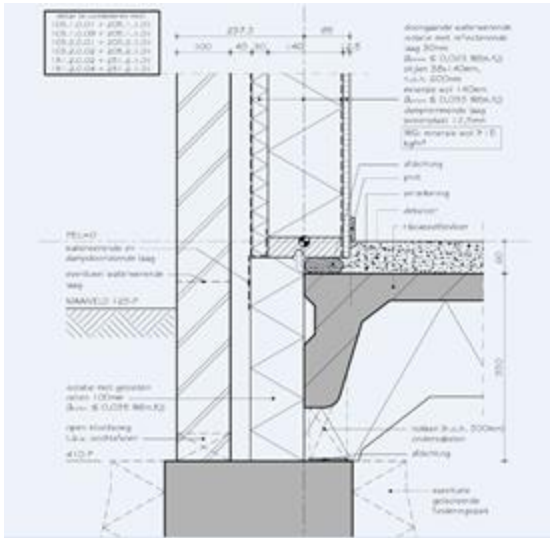
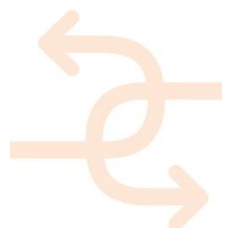

Figure 2: An example from the Netherlands

A wooden ground floor in new build houses is very uncommon in the Netherlands (even for timber frame houses).

As discussed during our telco we are not going to give solutions for every country but try to give information that is in general valid for every country.



APPENDIX 3 – Examples of different prefab constructions

Timber-frame elements

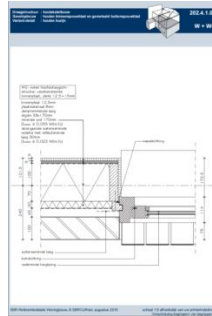

© SBRCURnet

Although we see a lot of different timber-frame elements, the structure has much in common. In general the composition of the timber-frame element is as follows (from inside tot outside);

- One or more layers of plasterboard, osb or wood board or a combination of it
- Vapour control layer (not needed in case of vapour permeable construction)
- Structural timber construction
- Thermal insulation between the structural timber construction
- Additional thermal insulation material in front of the structural timber construction (depending on the thermal demands)
- Breather membrane (no need in case of vapour permeable construction)
- Outside board
- External cladding

The prefabricated timber-frame elements can be supplied with or without the cladding. In the last situation the cladding will be added on site to the elements or a cavity wall with masonry will be build. Cables, ducts and wiring can be included during the production process.

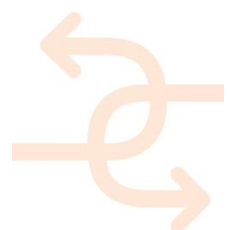

Steel frame elements



© SBRCURnet

Prefabricated LGS (Light Gauge Steel) steel frame elements have much in common with the timber frame elements. Instead of the timber frame construction, the construction is made out of cold-formed steel c- and u-profiles of 1 to 4mm thick. The prefabricated steel-frame elements can be supplied with or without the cladding. In the last situation the cladding will be added on site to the elements or a cavity wall with masonry will be build. Cables and wiring can be included during the production process.

Note the difference between steel frame elements and a construction on site with a steel bearing construction.

In general the composition of the timber-frame element is as follows (from inside tot outside):

- One or more layers of plasterboard, osb or wood board or a combination of it
- Vapour control layer
- Steel frame construction of c- and u-profiles
- Thermal insulation between the steel frame construction
- Additional thermal insulation material in front of the steel frame construction (to avoid thermal bridges by the steel profiles)
- Breather membrane
- External cladding

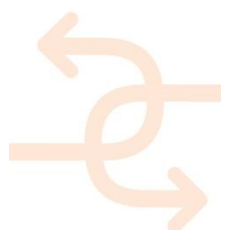

Sandwich elements

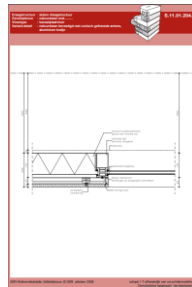

© SBRCURnet

A sandwich panel consists of two external layers and a core of insulation material. The surface layers are rigidly connected with the insulation material. We find sandwich elements where no additional cladding and inside finishing is needed. In this case metal is used quite often as surface layer. We also find sandwich elements which need additional finishing.

Concrete elements

Prefabricated concrete façade elements are quite common for decades. The prefabricated concrete elements can be supplied with or without insulation, with or without cladding and with or without the window- and doorframes already installed. Cables, ducts and wiring can be included during the production process.

- In general the composition of the concrete element is as follows (from inside tot outside)
- Concrete wall (thickness depending on construction)
- Insulation (thickness depending on thermal demands)
- External cladding



Brick façade elements

Prefabricated brick façade elements are not common yet. We see that suppliers of bricks (e.g. Sand-lime) try to industrialize and deliver complete facades.

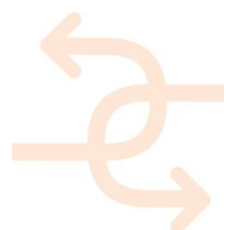

APPENDIX 4 - Description of the mounting of the timber frame elements and the procedure to guarantee the quality

In advance

A general mounting handbook, which is to set standards of quality and safety for mounting prefabricated timber frame elements contains at least:

- Organization structure with the tasks and responsibilities of the mounting employees;
- Responsible persons for the quality system on site;
- Procedures for the performance of the quality system on site including the registration of deficits and corrective measurements;
- Storage and transport of the prefabricated timber frame elements;
- Registration and handling of complaints;
- Safety at the building site;
- Documents needed at the building site;
- General demands relating to the performance of the mounting;
- Maintenance of measurements needed for meeting the demands (of the building code);
- The method of mounting;
- Reference details of the mounting including dimensions and tolerances;
- Principles of anchoring;
- Reception of the work including the control measurements.

Besides a general mounting handbook a complementary mounting handbook is needed for site specific conditions. A number of subjects and aspects of the general mounting handbook should be worked out in more detail. Especially the method of mounting, specific mounting details, principles of anchoring, the storage and transport on site and the inspection protocol.

The processing instructions should be 100% clear and contains at least:

1. Transportation to the building site
2. Unload, storage and transport of the element on site
3. Protection of the elements during transport, storage and building phase (after assembly)
4. Hoist and hoist provisions
5. Placing the elements to the construction including anchoring and fixing plan
6. Sealants, water resistant layers and overlap of foils
7. Adjustments and repair works
8. Treatments to the elements
9. Excepted tolerances (square, flat and perpendicularity)

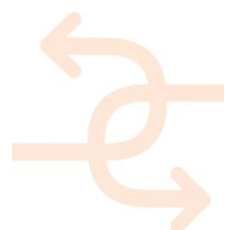

Before mounting

Before mounting of the prefabricated timber frame elements, the installer has to assess the practicability of the mounting.

1. Description of the prefabricated timber frame element and the position in the building
2. The quality assurance of the prefabricated element itself
3. The mounting details (connection) of the prefabricated timber frame element to another, on the foundation or to the bearing structure
4. Specifications of material to be processed and applied by the installer
5. The applicable requirements for the supply and removal of materials and waste on the building site

The above information needs to be agreed between the principal and the installer together with the work to be done.

Installation of the elements

The foundation, substructure and bearing construction (so all constructions where the prefabricated timber frame elements has to be connected to) must be constructed in such way that the prefabricated elements can be mounted in a responsible manner.

- Bearing capacity of the structure (based on calculations)
- The foundation, substructure and bearing construction need to be flat, square and straight to guarantee a good mounting
- Dimensional tolerances should be within the tolerances specified by the supplier

The necessary additional space between foundation, substructure or bearing construction and the timber frame elements needs a certain dimension so that:

- The accepted tolerances of the timber frame elements and the foundation, substructure or bearing construction,
- The movement of the timber element and
- The movement of the surrounding building elements can be dealt with and /or be prevented.

Where electrical cables, ducts are already installed in the prefabricated elements the position and the good quality has to be controlled before mounting.

Where electrical cables, ducts are carried through the element, arrangements shall be made to ensure the water tightness, airtightness, vapour tightness, insulation and the fire resistance.

After the installation of the prefabricated elements, the element should be protected to avoid damage and malfunctioning.

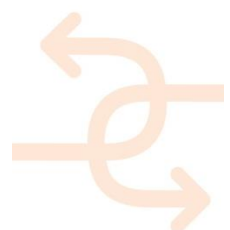

Dimensional tolerances of the prefabricated timber frame elements

The quality guarantee of the supplier should guarantee the dimensional tolerances and the flatness of the prefabricated timber frame element.

The opening for building in the prefab element has a maximum dimensional deviation according to the processing instructions of the supplier.

In the case of dimensional problems adjustments to the elements can be made according to the demands of the supplier.

Besides the dimensional tolerances of the elements, attention should be paid to the right position of the intra-wall installation facilities like pipes, electrical cables.

Materials

All materials used by the installation (placing, anchoring and connection) should be described.

In the Netherlands the BRL 1001 describes the performance requirements of materials of the prefabricated timber frame elements, mounting material, connection material and finishing material.

- Insulation material
- Foils
- Flashings
- Sealants
- Connection material
- Panels

Feedback loop

To prevent errors means that we have to learn from every error. The only way is that feedback is given to previous stages or to previous phases.

- Feedback of the errors to a previous stage in the assembly phase
- Feedback from the assembly phase to the production phase or to the design phase
- Feedback from the use phase to Quality assessment protocol, production phase and design phase

Feedback within the Quality assessment protocol itself.

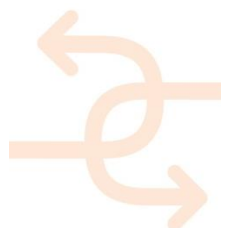

Description of the mounting of the timber frame elements and the procedure to guarantee the quality

We will describe the mounting of timber frame elements as an example for the quality control. Although there might be a difference between the mounting of different types of prefabricated elements and their quality control, the information can be derived from this example.

In advance

A general mounting handbook, which is to set standards of quality and safety for mounting prefabricated timber frame elements contains at least:

- Organization structure with the tasks and responsibilities of the mounting employees
- Responsible persons for the quality system on site
- Procedures for the performance of the quality system on site including the registration of deficits and corrective measurements
- Storage and transport of the prefabricated timber frame elements
- Registration and handling of complaints
- Safety at the building site
- Documents needed at the building site
- General demands relating to the performance of the mounting
- Maintenance of measurements needed for meeting the demands (of the building code)
- The method of mounting
- Reference details of the mounting including dimensions and tolerances
- Principles of anchoring
- Reception of the work including the control measurements

Besides a general mounting handbook a complementary mounting handbook is needed for site specific conditions. A number of subjects and aspects of the general mounting handbook should be worked out in more detail. Especially the method of mounting, specific mounting details, principles of anchoring, the storage and transport on site and the inspection protocol. The processing instructions should be 100% clear and contains at least:

- Transportation to the building site
- Unload, storage and transport of the element on site
- Protection of the elements during transport, storage and building phase (after assembly)
- Hoist and hoist provisions
- Placing the elements to the construction including anchoring and fixing plan
- Sealants, water resistant layers and overlap of foils
- Adjustments and repair works
- Treatments to the elements
- Excepted tolerances (square, flat and perpendicularity)

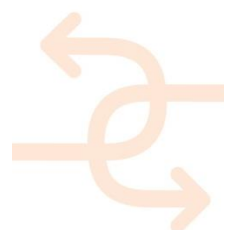

Before mounting

Before mounting of the prefabricated timber frame elements, the installer has to assess the practicability of the mounting.

1. Description of the prefabricated timber frame element and the position in the building
2. The quality assurance of the prefabricated element itself
3. The mounting details (connection) of the prefabricated timber frame element to another, on the foundation or to the bearing structure
4. Specifications of material to be processed and applied by the installer
5. The applicable requirements for the supply and removal of materials and waste on the building site

The above information needs to be agreed between the principal and the installer together with the work to be done.

Installation of the elements

1. The foundation, substructure and bearing construction (so all constructions where the prefabricated timber frame elements has to be connected to) must be constructed in such way that the prefabricated elements can be mounted in a responsible manner.
2. Bearing capacity of the structure (based on calculations)
3. The foundation, substructure and bearing construction need to be flat, square and straight to guarantee a good mounting
4. Dimensional tolerances should be within the tolerances specified by the supplier

The necessary additional space between foundation, substructure or bearing construction and the timber frame elements needs a certain dimension so that:

5. The accepted tolerances of the timber frame elements and the foundation, substructure or bearing construction,
6. The movement of the timber element and
7. The movement of the surrounding building elements can be dealt with and /or be prevented.

Where electrical cables, ducts are already installed in the prefabricated elements the position and the good quality has to be controlled before mounting.

Where electrical cables, ducts are carried through the element, arrangements shall be made to ensure the water tightness, airtightness, vapour tightness, insulation and the fire resistance.

After the installation of the prefabricated elements, the element should be protected to avoid damage and malfunctioning.

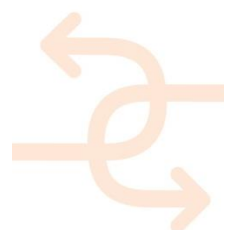

Dimensional tolerances of the prefabricated timber frame elements

The quality guarantee of the supplier should guarantee the dimensional tolerances and the flatness of the prefabricated timber frame element. The opening for building in the prefab element has a maximum dimensional deviation according to the processing instructions of the supplier. In the case of dimensional problems adjustments to the elements can be made according to the demands of the supplier. Besides the dimensional tolerances of the elements, attention should be paid to the right position of the intra-wall installation facilities like pipes, electrical cables.

Materials

All materials used by the installation (placing, anchoring and connection) should be described.

In the Netherlands the BRL 1001 describes the performance requirements of materials of the prefabricated timber frame elements, mounting material, connection material and finishing material.

1. Insulation material
2. Foils
3. Flashings
4. Sealants
5. Connection material
6. Panels

Feedback loop

To prevent errors means that we have to learn from every error. The only way is that feedback is given to previous stages or to previous phases.

1. Feedback of the errors to a previous stage in the assembly phase;
2. Feedback from the assembly phase to the production phase or to the design phase;
3. Feedback from the use phase to Quality assessment protocol, production phase and design phase;
4. Feedback within the Quality assessment protocol itself.

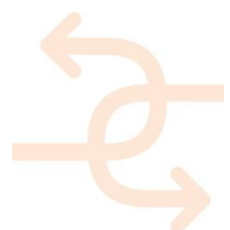

APPENDIX 5 – Description of four types of glazed walls

Stick system

Description

Stick-built glass façades are a curtain wall construction where much of the fabrication and assembly takes place in the construction site. Mullions of extruded aluminium may be prefabricated, but are delivered as unassembled “sticks” to the building site. The mullions are then installed onto the building face to create a frame for the glass, which is installed subsequently. Horizontal and vertical framing members (mullions or “sticks”) are normally extruded aluminium protected by anodising or powder coating, but may be cold-rolled steel (for greater fire resistance) or aluminium clad with PVC-U.

Installation

Members are cut to length and machined in the factory prior to assembly on site as a kit of parts: vertical mullions, which are fixed to the floor slab, are erected first followed by horizontal transoms, which are fixed in-between mullions. Mullions are typically spaced between 1.0 and 1.8m centres. Into the framework are fitted infill units, which may comprise a mixture of fixed and opening glazing and insulated panels (which may have metal, glass or stone facings). These units are typically sealed with gaskets and retained with a pressure plate, screw-fixed every 150-300 mm, although hammer-in structural gaskets are used for some stick systems. The pressure plate is generally hidden with a snap-on cover cap or overlapping gaskets. The screw fixings can be exposed by removing the cover, which is typically produced in six metre lengths for vertical framing elements. Fixings must be secured to the correct torque to retain the glazing/infill panels and to ensure proper compression of the gaskets for weather sealing.

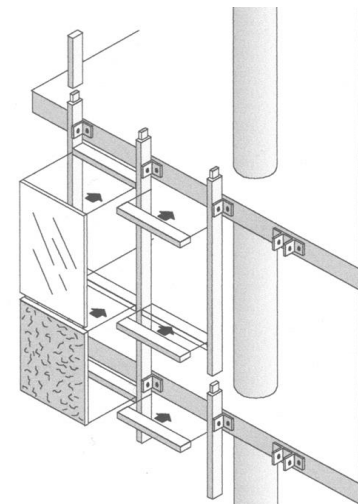

Stick System

Stick system curtain walling may be erected in one of three sequences that determine a different configuration of joints and sealing:

Mullions installed then transoms.

Mullions and transoms installed sequentially.

Ladder frames installed then intermediate transoms.

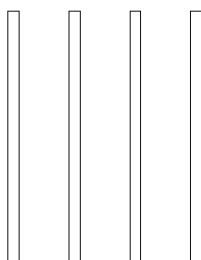

Mullions installed then transoms

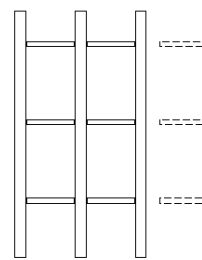
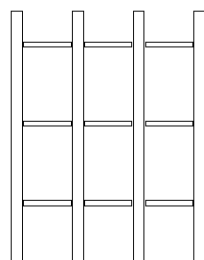

Mullions and transoms installed sequentially

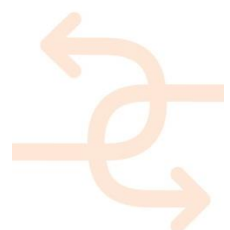
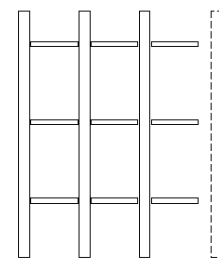

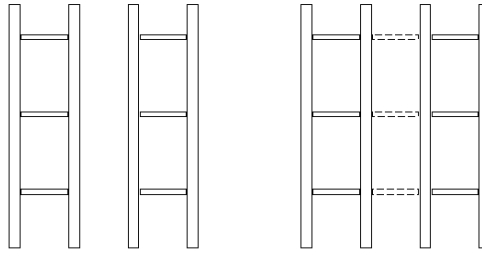

Ladder frames installed then intermediate transoms

Main emerging issues

Because of the number of joints in stick curtain walling, such assemblies are generally very good at accommodating variabilities and movement in the building frame. It is also suitable for irregular shaped buildings and refurbishments.

Assembly procedure is slow compared with pre-assembled systems.

Performance (i.e. weather tightness) mainly depends on installers who are familiar with the assembly and sealing procedures for the particular system.

Unitised (or modular) system

Description

Unitised systems comprise narrow, storey-height units of steel or aluminium framework, glazing and panels pre-assembled under controlled, factory conditions. Vertical and horizontal mullions of the modules mate together with the adjoining modules. Modules are generally constructed one story tall and one module wide but may incorporate multiple modules.

Installation

Mechanical handling is required to position, align and fix units onto pre-positioned brackets attached to the concrete floor slab or the structural frame. Units or panels may be of precast concrete or comprise a structural steel framework, which can be used to support most cladding materials. Joints may comprise casketed interlocking extrusions, gaskets between separate extrusions or wet applied sealant.

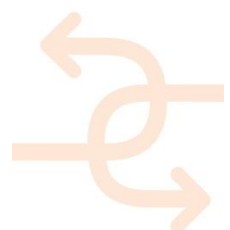
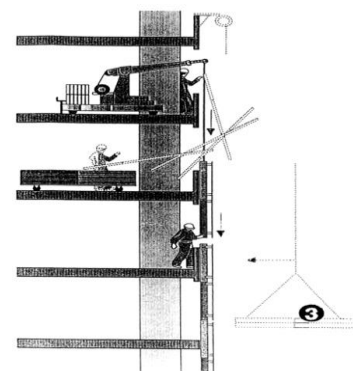

Installation of a unitised assembly

If construction joints interlock consideration must be given to how damaged units could be removed and replaced. The reduced number of site-made joints compared with stick systems, generally leads to a reduction in air and water leakage resulting from poor installation.

Main emerging issues

- High utilisation of prefabrication, which allows better quality control and rapid installation with the minimum number of site-sealed joints.
- Unitised systems are more complex in terms of framing system, have higher direct costs: a large number of identical panels is required in order to be cost effective.
- The size and weight of panels is limited by the practicalities of manufacture, handling, storage, transport and erection.

Structural sealant glazing

Description

Structural sealant glazing is a form of facade that uses a structural sealant to attach glass, metal or other panel material to the structure of a building. Glazing panels are glued externally to the steel structure mainly by structural silicone. In addition, some additional mechanical anchorage can be provided. This kind of facade, also known as VEC, offers a continuity of the external glass surface, only interrupted only by the lines drawn by the thin thickness of the joints. The sealant must maintain adhesive and cohesive integrity as the façade is also subjected to thermal stresses: external joints are weather sealed with a wet-applied sealant or a gasket (non-structural silicone).

Installation

There are many different types of structural glazing systems available. Two of the more common types of systems are 2-sided SG and 4-sided SG. Structural sealant glazing systems can have sealant on two opposite sides: the other two sides of the glass are either mechanically supported or are not structurally supported by a frame. The most common and usually cost efficient type of structural glazing is 4-sided SG systems, since glass is supported on all four edges of the glass with structural sealant and such systems are typically fabricated in a production facility and erected at a jobsite.

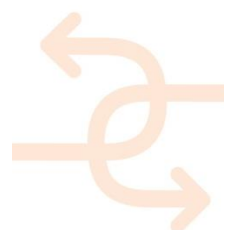

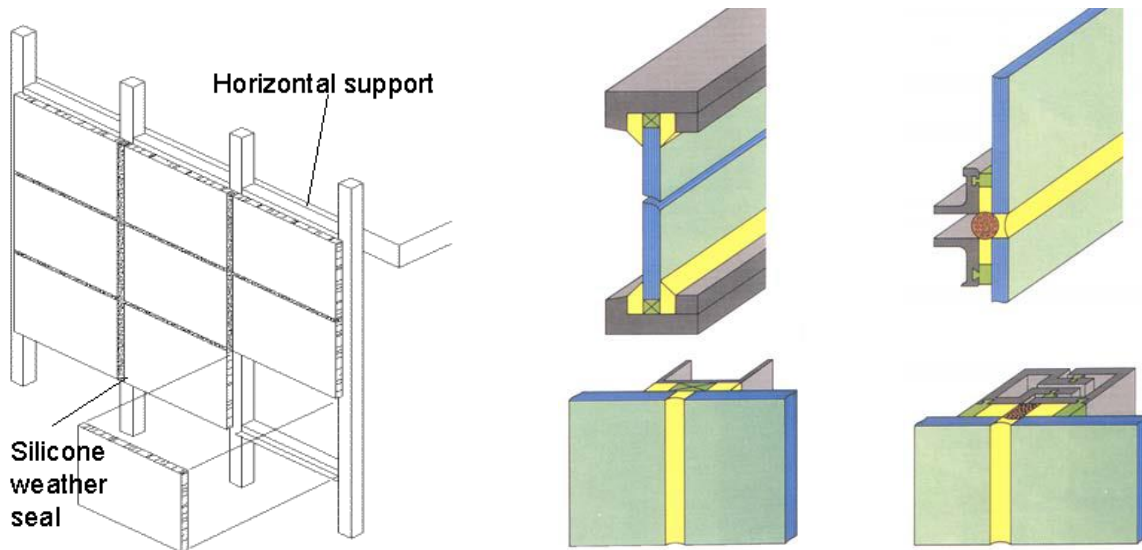

Structural sealant glazing

2-sided Structural Glazing

4-sided Structural Glazing

The tightness of the system may be ensured by the presence of small horizontal projections that help to hold the weight of glass panes, while the shear forces and those produced by pressure and depression of the wind are entrusted to the sealant. The presence of this element allows compensating for the possible creep of the structural silicone along the perimeter of the slab.

Main emerging issues

Construction limitations, especially related to safety: the uncertain structural behaviour imposes the adoption of high safety coefficients and the use of additional mechanical anchorage, consisting of small protrusions that provide support for slabs and remain almost invisible at a distance of 3-5 m.

The installation is slow and must be carried out by external scaffolding.

Significant risk of spontaneous breakage of the glass panels, which edges are exposed, due to NiS inclusions (HST recommended).

The structural silicone sealant must be tested for compatibility with all other sealants and materials that it may contact.

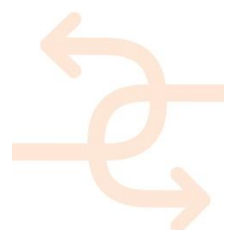

Point-fixed facade

Description

In point supported structural assembly, also known as VEA, glass panes are bound to the main structure through separate connecting elements (brackets and/or cables) instead of a frame. This is a system of frameless glazing wherein glass units or panels are bolted together due to an independent support structure, or to glass fins, and the joints in between them sealed with structural joints. Glass sheets are fastened to the support structure by point-fixed devices in correspondence of the four corners; different technologies are available for the types of fixings and the design of the joints, developed by different manufacturers (Saint Gobain, Pilkington).

Installation

Point-fixed assemblies can be complex and depends on design loads, seismic movements, support structure and glass support method. Frameless systems utilize glass panes that are fixed to a structural system at discrete points, usually near the corners of the glass panel (point-fixed). The glass is directly supported without the use of perimeter framing elements. The glass used in point-fixed applications is typically heat-treated, and can be single-glazing, laminated single glazing or double-glazing. The bolted glass assembly system requires finished glass products of the highest quality in terms of edge-work, drilling, toughening and heat soak testing. Each production stage must be quality controlled to the highest standard.

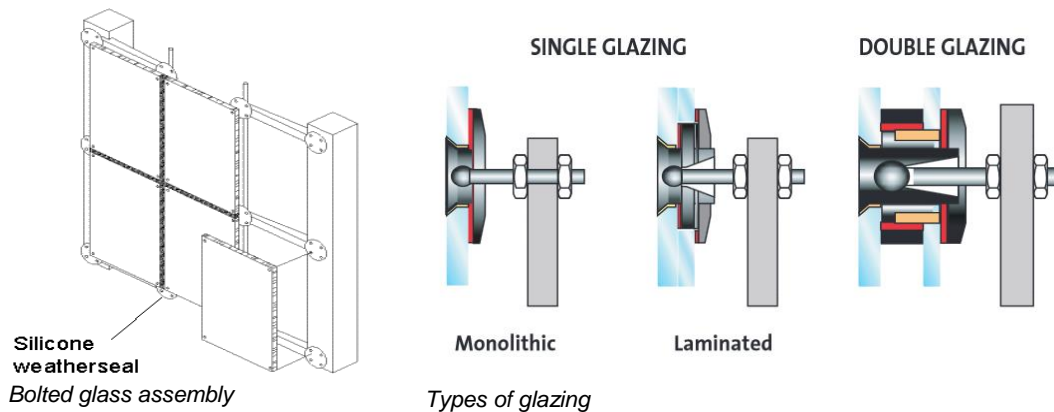

Throughout the manufacturing process, particular attention is paid to two aspects: dimensional accuracy and the toughening and heat-soak testing of the glass. All edgework must be completed before the toughening and heat soak test stages. The glass cannot be altered in any way after this treatment. The weather seal in most structural glass façade systems is provided by a field applied butt-glazed silicone joint. This technique provides a reliable and durable weather seal if simple procedures are followed during installation. An advantage of this sealing strategy is that any leaks, usually caused by installation errors, are easily detected and repaired. The joint design is critical, and is largely a function of the glass pane and thickness.

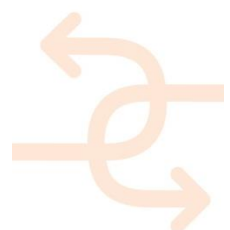

Main emerging issues

Compatibility between the field-applied silicone and the interlayer, if using laminated glass, or the edge seal in the case of an IGU, must be confirmed with the silicone material manufacturer.

Craftsmanship is critical for the field application of the sealant to assure a satisfactory result.

Joint realization is crucial and the water tightness of the façade depends exclusively on the performance characteristics of the sealant and the accuracy of installation.

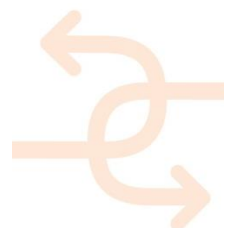

APPENDIX 6 - Typical assembly process (as self- instruction later on)

Steel

Steel frames can accommodate all types of roofs, from watertight roofs to flat or arched roofs, as well as opaque or glass roofs.

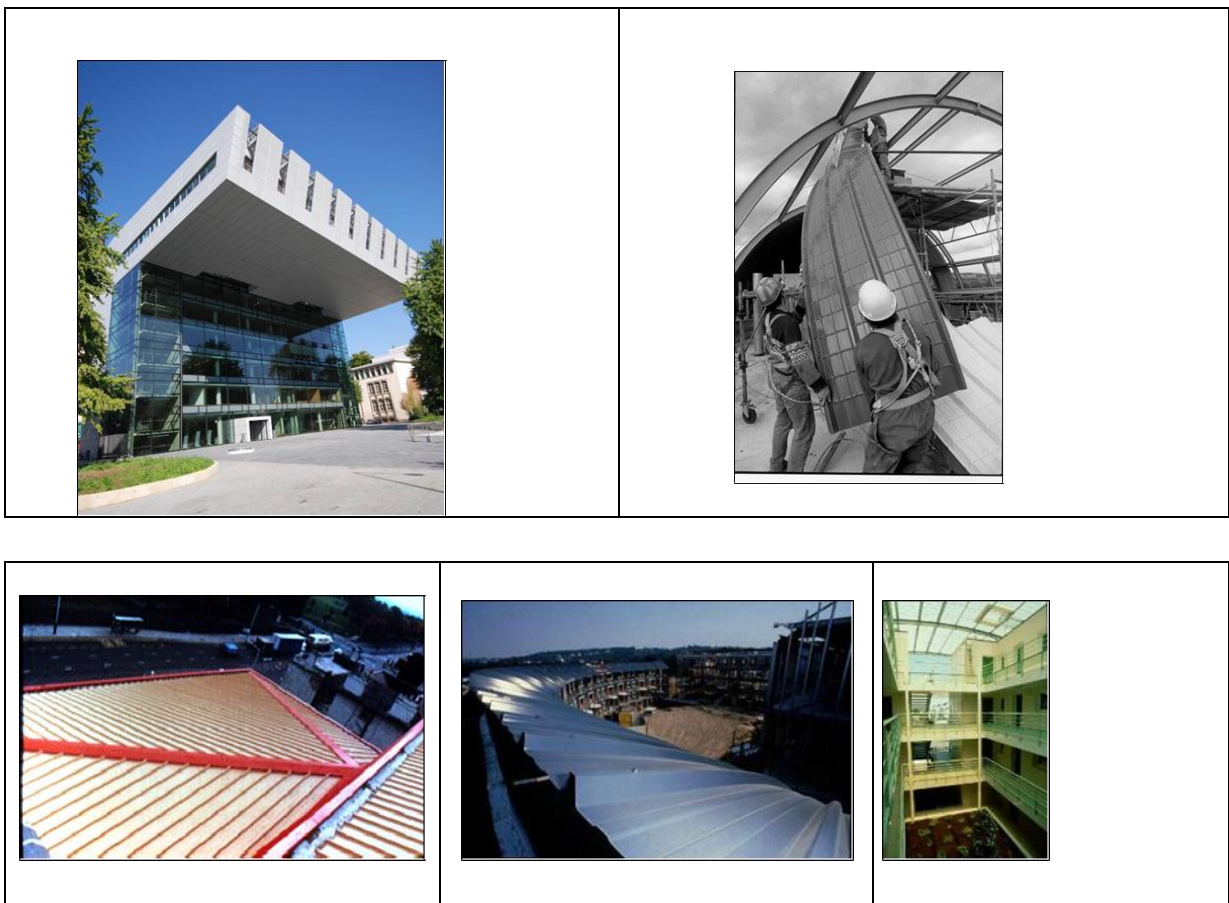

The building envelope needs to respond to many different requirements.

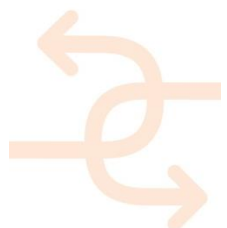

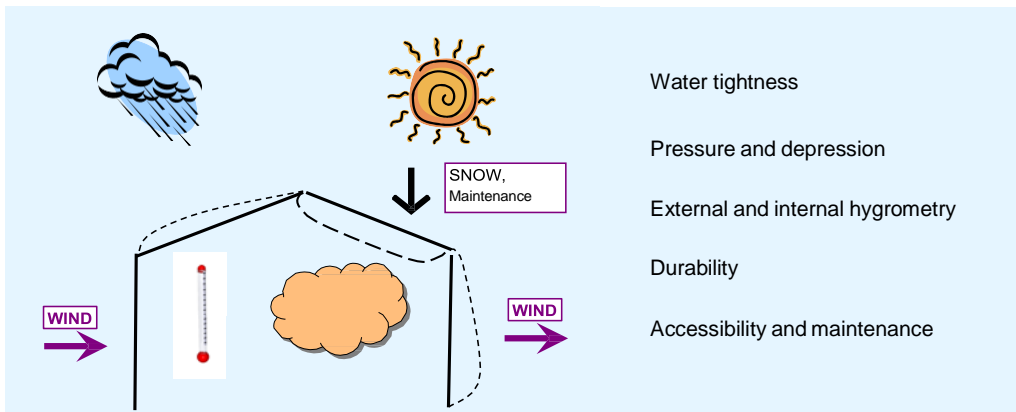

Roof typology depends on several criteria, including shape, roof slope, external appearance, material colour, type of support and the materials used.

Roofs are usually divided into three types:

- Flat roofs with no slope
- Pitched roofs (slope between 3 and 7%)
- Steep or arched roofs

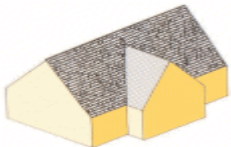
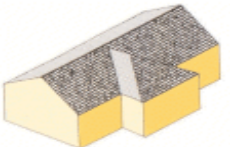
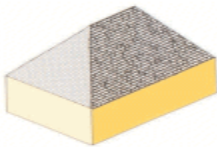
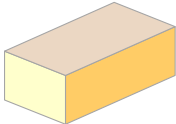
			
'T' Intersection roof with gable side	Overlaid Hip roof with gable side	Hipped roof	Flat roof

For low slope roofs, the most important elements for the steel frame are the quality of fixings and arrangements for rainwater evacuation.

The principle of flat roofing systems on surface support elements can be applied using lightweight partitions, a metal sheet or the concrete topping technique with a concrete compression decking.

A vapour screen, thermal insulation and waterproofing, with or without protection, are installed on the upper side. In order to provide the parapet which will be used to increase water tightness, it is possible to use a secondary steelwork façade which can be extended to the required height.

In the case of a low pitch roof (slope between 3 and 7%), water tightness is also obtained by applying bituminous products or PVC watertight membranes. Insulation is applied directly to the galvanized steel sheet tray. The process is light and economical for non-accessible roofs. Phonic insulation is adjusted through thickness of the materials and the order in which these are superimposed.

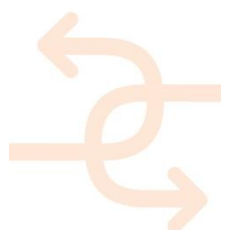

Screw hook

- Fixing on steel purlins with self-drilling or self-tapping screw
- Fixing on wood purlins
- Fixing without cover piece

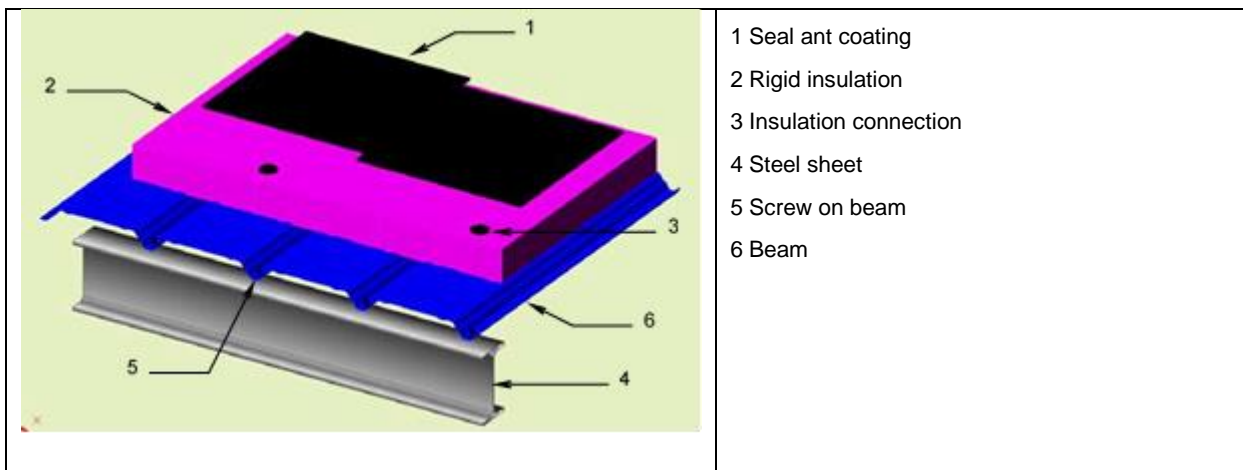
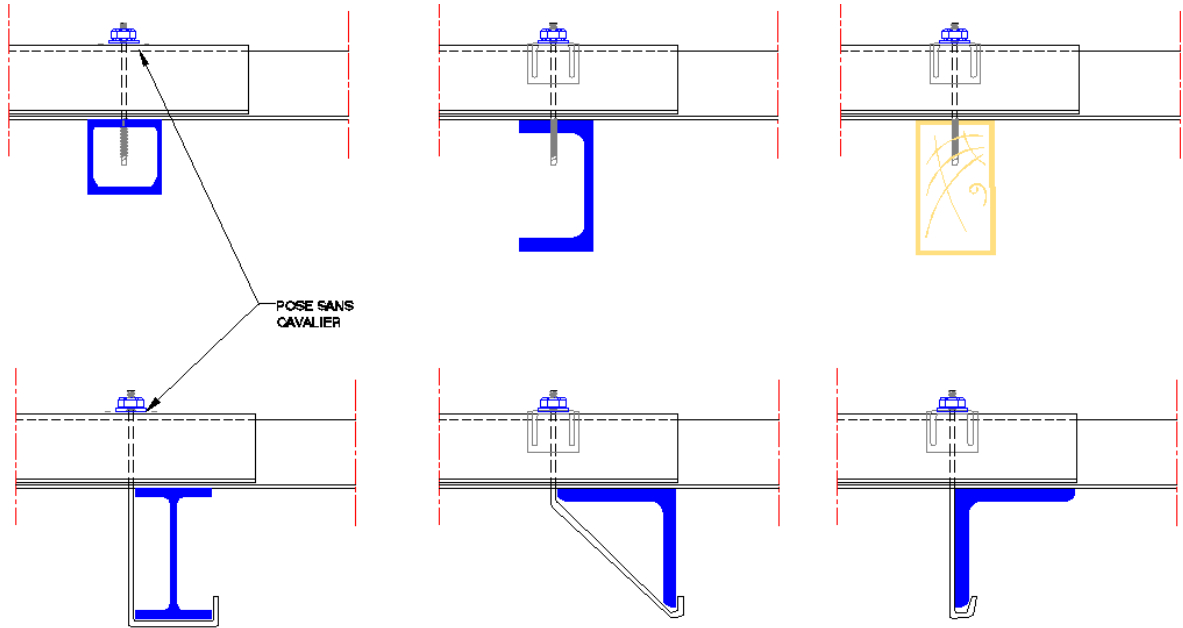

Typical view of a flat roof

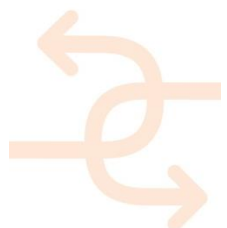



Corner of façade and roof – On site view

Water tightness is easily obtained by overlapping of the metal sheets, more or less following the roof slope and the product. The most common procedure is to superimpose materials so that all air space is eliminated.



Curved roof

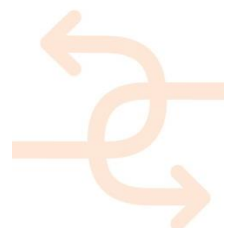

A typical roof construction, from the exterior inwards, consists of:

- A ribbed steel decking fixed perpendicular to the panels;
- A primary layer of insulation made of a taut felt sheet combined with an internal vapour screen placed between the decking and panels;
- A second and thicker layer of mineral wool;
- A steel frame on which to fix the product which is used for the internal finish;
- A second vapour screen;
- An internal finish facing material, of one or two layers of plasterboard screwed to the steel frame or, in some cases, steel decking or perforated steel decking;
- Acoustic insulation to control rain noise is particularly effective.

Roof netting systems with different amounts of perforation can be fixed on metal roofs to handle thermal shock and to improve the architectural concept using a canopy. Galvanized steel sheets, whether pre-painted or not, and stainless sheets, are particularly suitable for arched roofs. Stiffening ribs improve bending strength. The plates are supported by panels, the characteristics of which determine the spacing and loads to be carried. Fixing is carried out above the stiffening ribs, using compressed watertight joints.



Curved roof with galvanized steel sheet

The roof can be designed to accommodate various systems for renewable energy, such as solar panels or wind turbines with vertical axis.

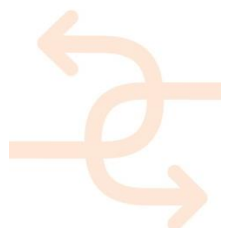



Photovoltaic panels installed on a roof



Array of small-scale vertical axis wind turbines on a flat roof

Wood

The solutions for the realization of the cover are not strictly related to a specific type of construction, but generally are associated to different types of buildings. For this reason, in the following section we report the entries for some possible solutions for cover by abandoning the division according to type of construction of elevated structures.

Roofs with beams and joists

It is roofs made with the laying of laminated wood or solid elements of various sizes and lengths to each other and fixed to the bearing structure with elements of ordinary and special hardware. The structure is completed by a generally planking with thickness between 2-6 cm worked or left rough. The package cover then sees the laying of a first breathable windproof sheath, the layers of thermal insulation in breathable material supported by laths and a second array of elements of small size that in addition to functioning as elements door roofing (roof tile batten door), realize a ventilation chamber. This must be protected by a network mail both at the level of the eaves that at the level of the ridge so as to allow the circulation of air but prevent the entry of animals. The insulation must be protected by a breathable waterproof membrane placed generally in the second frame of strips. The roofing can be made with brick tiles (tiles, roof tiles from Marseilles or Portuguese), shingles (bitumen), with corrugated sheets and other methods that are part of the local traditions.

If you do not employ breathable insulation must be replaced windproof jacket with a vapour barrier and the top sleeve with a non-breathable waterproof membrane, generally bitumen; in this way, it is realized a non-breathable cover.

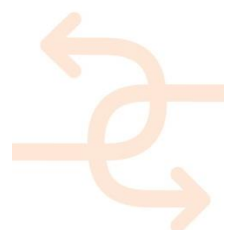

Cover with panelled construction

This type of cover, usually coupled to the buildings with load-bearing panels, is realized with the laying of a solid cross-laminated panel to support the package cover. Are achievable both flat roofs that pitched. Over the carrier panel are placed the layers already described in the case of coverage beams and joists.

Roof truss read

It is a type of cover that is usually associated with the type platform frame buildings. The roof structures are made by joining with toothed plates of solid wood planks structural matched to form the geometry of the truss. The distance between the bottom which are placed such elements allows laying directly a plank which supports the package cover realized as in the case of coverage beams and joists.

The spread of laminated wood and the improvement of numerical control machines, which have allowed the prefabrication, have also fostered the development of modern connection systems realized by means of the insertion of metal elements or the use of adhesives.

The modern mechanical joints can be classified according to the type of connector used:

- Connectors with cylindrical shank metal (nails, bolts, pins, screws and staples)
- Metal surface Connectors (ankles, rings, toothed plates)
- Preformed plates (thin plate cold bent or aluminium) for connection between main beams and secondary beams generally available in the catalogue and with technical documentation of the manufacturer certifying the minimum flow values.

The wide choice of connection type allows you to give priority to the speed of the assembly or the flexibility of the configuration of the structure.

The secondary beam connection can be made in "support" on the main beam or "thick".

In the link support, it is preferable to avoid shapes of the ridge and run the notches on the secondary beam so as to achieve a flat, horizontal surface of support. The connection must be completed with a set screw.

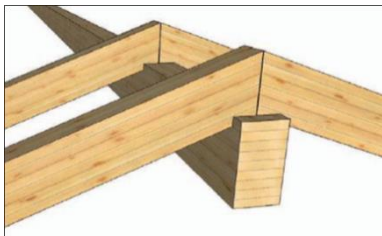

Shaping of the strut for the realization of a horizontal support. (Recommended)

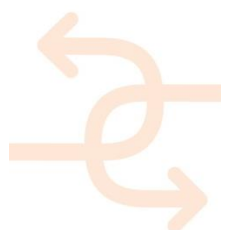

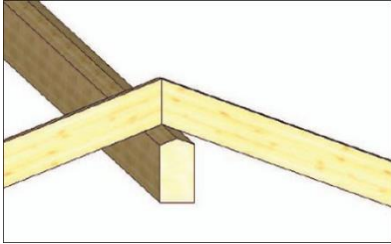

Shaping the ridge (not recommended solution: because the structure is pushing and strength must be balanced by the connecting screw)

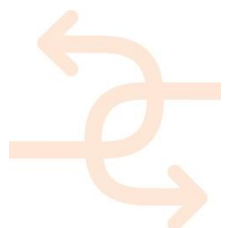

The link in thickness allows a very easy and quick to install, but it is very important to know the passage of equipment (chimneys, antennas).



A better mechanical behaviour, that preserves the simplicity of installation, can be obtained by resorting to the connection with self-tapping screws, to full thread or double thread, arranged at X inclined at 45 °. They avoid the disadvantages due to necking and you get a static scheme type trellis. The screw stuck in the main beam works primarily in tension, the bolt stuck in the secondary beam is compressed: they act as a diagonal stretched and compressed, as in the pylons, and verification to be performed is to screw strength (resistance to pull out of the threaded shank). Also from an aesthetic point of view the result is qualitatively high because it is a retractable link (the reduced form of the screw head, torx carving, it comes fully hidden inside the beams).



A difference of the dovetails, greater flexibility in the positioning of the beams, at the expense of the shutter speed, can be obtained with metal connection systems, such as "shoes" and "retractable plates" stainless steel or aluminium. In this case the checks to be made are those of the plates (the manufacturer provides the value of the flow rate) and of cylindrical connectors (nail, screw, pin, bolt), primarily to pressure loads and shear strength, used for their fixing.

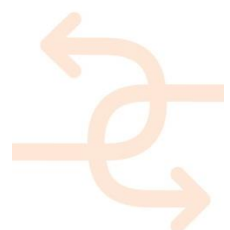

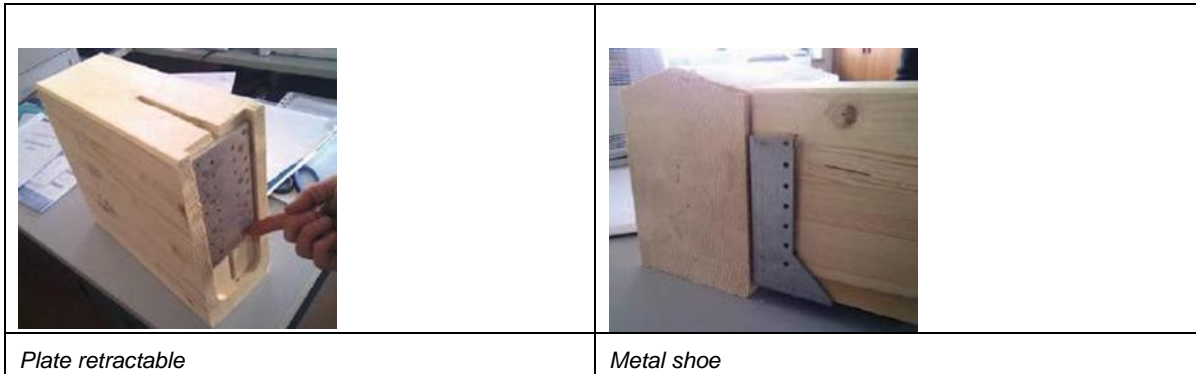

The mechanical joints are preferred since they give the structure the ductility and energy dissipation required for resistance to earthquakes. However, in some cases, it is appropriate to realize rigid couplings. For this purpose we use the unions with glued rods or metal plates glued.

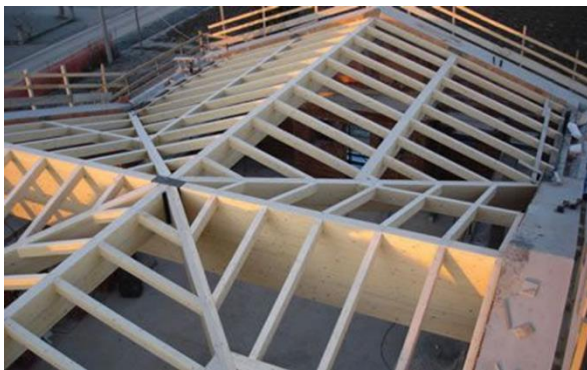

Pasted unions transfer from wood to the efforts of union bars along the bonding length enabling the achievement of high rigidity values. In addition, they have advantages in respect of corrosion and fire protection (the metal elements are within the beam and therefore protected) and a better aesthetic result because the joint is not visible. The epoxy resins are the most widely used adhesives. It is important that not too much liquid in order to avoid seepage which empty the bonding area and go to fill any cracks of the wood, preventing the movements. To this end, it is good to "load" the resins with mineral fine aggregates (filler) to achieve the right consistency thixotropic.

To ensure the compatibility of the materials, the bars must be glued along the grain:

along the direction of the wood has negligible shrinkage and bulging. A rod inserted transversely to the grain counter to the withdrawal and the swelling of the wood creating dangerous cutting alternating residual stresses on the bond. Bars can be used as the common of improved adherence steel rods that show sufficient adhesion with epoxy mortar.

Alternatively, fiberglass rods, definitely more expensive.

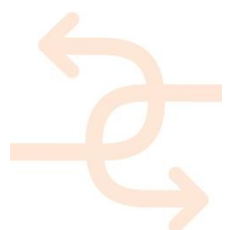



A well-designed cover must be laid at a workmanlike manner by qualified personnel, to ensure the expected performance.

The attention to detail is the necessary condition for the durability of the structure and interior comfort.

Wood elements protection

At the points where the beams are in contact or pass through the masonry, if this is a carrier of moisture, it is appropriate to protect them to avoid likely formation of mould and cracks of interior finish which usually propagate from the corners. For this purpose, you can use special seals that follow the dimensional variations of wood (shrinkage and expansion). For example, the rolls in the polyolefins on which two tubes are welded EPDM: the roll prevents the passage of moisture on the beams and the tubes prevents the passage of air. These elements can also be employed between masonry and platform beam.

Another aspect not to be overlooked is the protection of the heads of the outgoing beams from the perimeter: the water penetrates much more easily along the direction of the fibres in the transverse direction. You must break the edge of the beam 5-6 cm before the last bead, shape the beam so as not to be wet from the falling rain with a 45 ° tilt, and provide protection with a flashing (called drip).

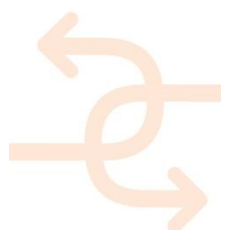
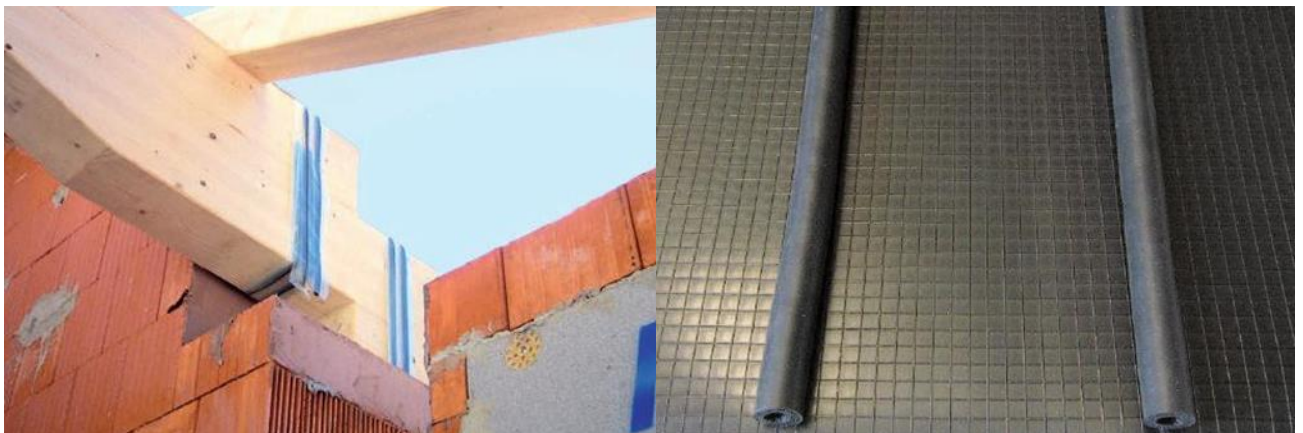

Node roof - wall

The insulation continuity and air tightness in the roof-wall node is difficult to achieve when the wooden louvers are passing through the masonry.

To overcome this, in new buildings, structural elements (beams and beads) are made in correspondence of the end wall, or on the edge beam.

Above these structural elements are placed on planks and steam brake. The latter must be turned up on the outer side of the wall, before laying the coat of the facade, so as to ensure the perfect continuity of air tightness between the wall and roof. The overhang of the roof is achieved by placing, on top of the plateau and the vapour barrier, fake joists ("rafter") at the rafters.

The insulation will be continuous from the ridge to the beginning of the rafter ends, then it will be punctuated by fake beams and will end at the projecting part where it connects to the isolation wall. Above the rafter it is laid a plank that ends where the insulation is continuous.

This plank is required for the installation continues the breathable fabric and the ventilation layer strips that must continue and join in the eaves.

Features of the sealing elements for the laying

In the choice of the sealing elements must be taken into consideration in addition to the functionality, also the method of laying influenced by the mass per unit area and the mechanical strength.

In case of laying of continuous elements (panels, boards, panelling) The sealing elements are not particularly stressed if not from foot traffic. The only requirement to be met is that of a sufficient mass (at least 145 g / m²).

On the contrary, in the case of laying of discontinuous elements, such as the containment of the insulation strips, assume great importance the mechanical resistance to tearing measured by the "nail" method and the longitudinal resistance as a function of the wheelbase of the supports.

For the application of SMT (Screens and Membrane Breathable) synthetic remember the following European regulations:

- EN 13859-1 Breathable membranes for roofing
- EN 13859-2 breathable membranes for facades
- EN 13984 Screens for vapour control

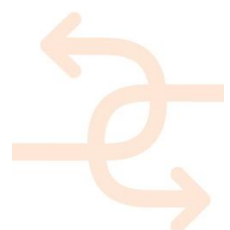

Pose of the sealing elements



Screens and breathable membranes must be laid stretching rolls in the sense of the flap length in successive strips starting from the eaves to the ridge.

The bands will have to be surmounted on one another with appropriate overlap: minimum 10 cm for gradients greater than 30%, minimum 20 cm for slopes below 30%.

The upper edge of the screen, or membrane, identified, in general, by a dashed line overlap, to be fixed to the support by means of staples or wide-head nails.

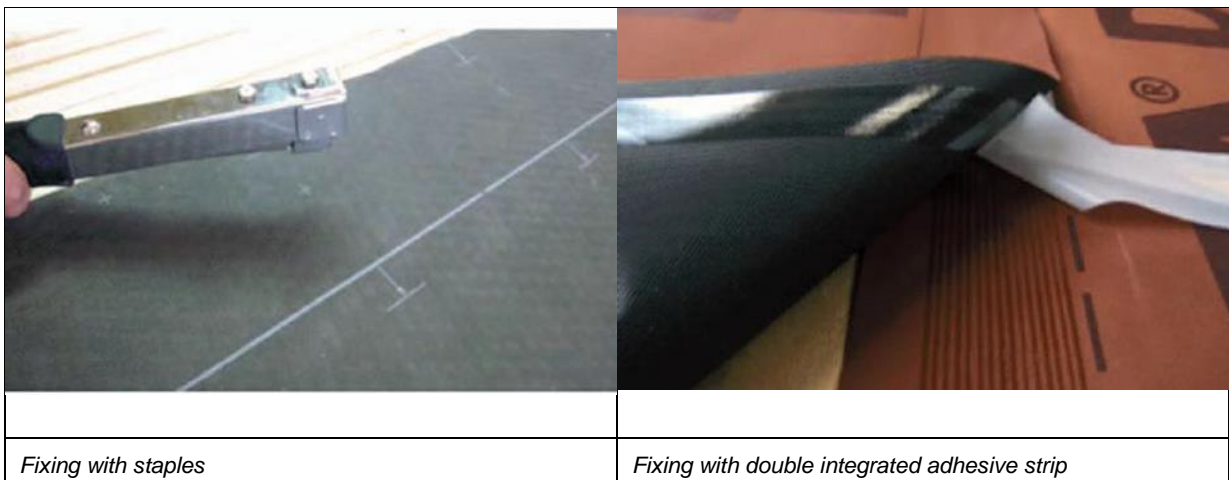

The overlapping areas must be sealed with suitable adhesive systems (tapes, integrated bands, double sticky tapes, adhesives and sealants) in the manner specified by the manufacturer.

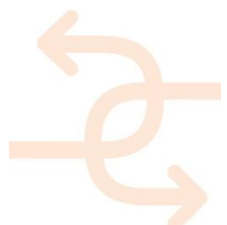

The vapour control screen will be turned in front to ensure the continuity of air tightness in the roof node wall. The corbels will be fixed on the panelling above the interposing brake sheath point nail.



The breathable membranes can be fixed directly on insulating (non-flexible) with clips, glue or clout nails

Fixing at the eaves



Detail of the laying of the breathable membrane in the eaves

In case of water seepage through the roof covering, the breathable membrane must allow the outflow and the water evacuation.

The membranes, by their nature, cannot remain permanently exposed to UV rays and, therefore, must not depart from the gutters. They must, therefore, be withdrawn prematurely and connected to the gutter using a metal flashing or adhesive strips in aluminium. We proceed then to the sealing with adhesive tape or glue.

Seals "Nail point"

Prior to mounting of the ventilation battens, care must be taken to interpose between the membrane and the gasket strip called "nail point" (Seal bands polyethylene / EPDM or foaming glues) to prevent the infiltration of water in the points wherein the counter batten of the fastening screw goes to pierce the membrane.

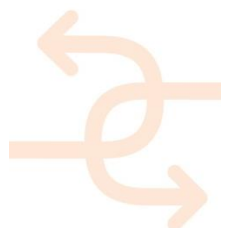

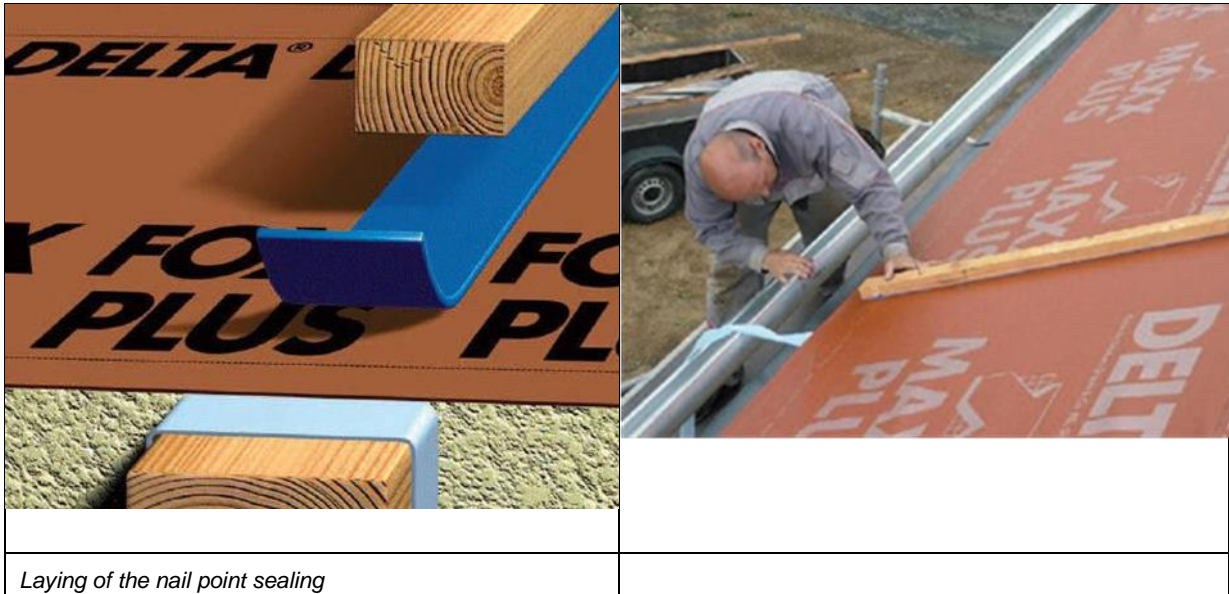

Laying of the nail point sealing

Fixing at the ridge

With single ventilation chamber, made with batten and counter batten, the brake is that the membrane must overlap by at least 20 cm and sealed with adhesives or adhesive band.



Laying of the breathable membrane straddles the ridge: overlapping the dotted line

When you have a primary and a ventilation micro-ventilation under tiling separated by a plank, the latter and the breathable membrane fixed on it must terminate few centimetres before the ridge line to allow proper ventilation.

The vapour barrier must be surmounted as before.

Finally, the ridge must be protected and waterproofed by means of the "roll under-ridge" that guarantees the correct ventilation in every case.

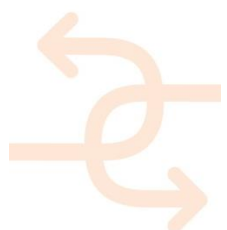

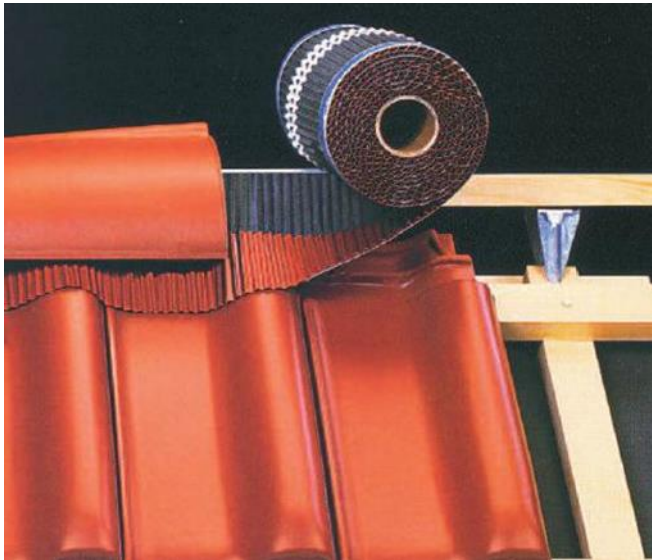

Measures to be taken in the pose at the openings (skylights, dormers, chimneys, aerators)

The screen fitting through the penetrations must be made by cutting the edges, folding the edges and sealing them on the sides of the structure by means of tapes, glues.

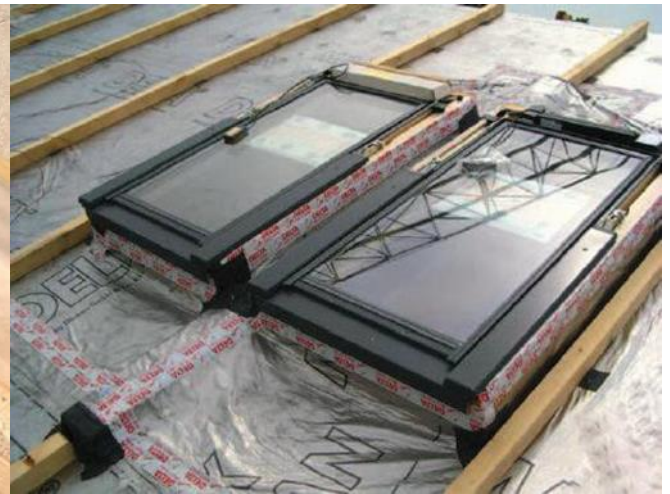

The vapour barrier flap in kinks



Chimney connection - roof covering.



Sealing of curved elements (aerators) by elastic adhesive strip.

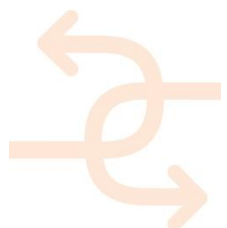

APPENDIX 7 - Addition and overlapping strategy cases

The annex proposes several examples of real EU cases that applied the refurbishment strategies presented in the chapter 7 of this deliverable.

These examples demonstrate as these solutions are very diffuse in all European countries and for this reason the INSITER protocol in refurbishment will have an important impact on the market to reduce the construction errors, cost and time as well as to improve the energy performance.

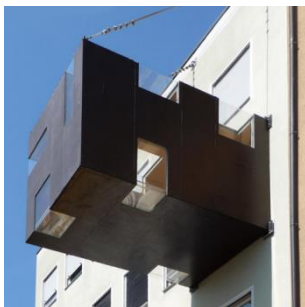

Case 01 - Rucksack house

Location: Leipzig, Köln (Germany)
Year: 2004

The Rucksack house offers a way of improving housing quality. The cube is a light and empty space, free from connotations and open to its user's needs. While still being inside a private atmosphere, one has the impression of floating outside of the confines of the actual dwelling above the public space. The Rucksack box is suspended from steel cables that are anchored to the roof or to the facade of the existing building. The construction is a welded steel cage with a light birch veneered plywood interior cladding.

<http://www.stefaneberstadt.de/rucksack.html>

http://www.convertiblecity.de/projekte_projekt02_en.html

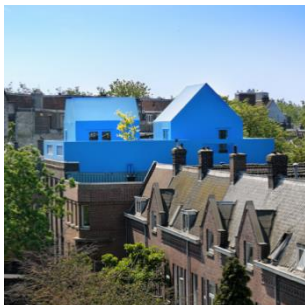

Case 02 – Didden Village

Location: Rotterdam (The Netherlands)
Year: 2006

Rooftop house extension in Rotterdam. On top of an existing historic house and atelier, the bedrooms are positioned as separate volumes, small houses in a rooftop village, creating privacy for every member of the family. The houses are distributed in such a way that a series of plazas, streets and alleys increase the feeling of a village on top of a building. The addition can be seen as a prototype for the further densification of the existing city.

<https://www.mvrdr.nl/projects/didden>



Case 03 – House Ray1

Location: Wien (Austria)
Year: 2003

Situated on the flat roof of a 1960s office building in Vienna's fourth district. Ray 1 evolved out of the direct stimuli and spatial quality of the location. This origin, however, is by no means contradicted by the clash of the static mass and the dynamic form of architecture in motion; this juxtaposition rather serves to charge the structure. The new building evolved out of the connection between the two buildings on either side, continuing the line of projection of the gables and providing, as it were, the missing link.

<http://www.dmaa.at/projekte/detail-page/house-ray1.html>

<http://www.werkraum.com/>

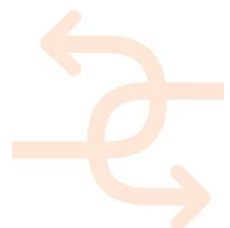



Case 04 – Culture bunker

Location: Frankfurt (Germany)
Year: 2005

Upward extension in wood technologies of a bunker in the east harbour area of Frankfurt. One reason for that was the leaking hip-roof, as a reparation of it would have been very expensive. However, a demolition was out of question because of the enormous costs. So the bunker turned somewhat into an elevated construction site. Like on a rock in the city, a carefully calculated wooden box will sit up there, harbouring artists' studios and the Institute for New Media. Inside the heavy concrete core, rooms for musicians to exercise will be installed.

<http://www.index-architekten.de>



Case 05 – School of art

Location: Paris (France)
Year: 2000

Conversion of university library building in St Denis. Existing structure realized in load-bearing system, concrete coffered floors and precast concrete columns. To improve the sound insulation, the floor construction was increased in thickness, acoustic slabs were added to the plasterboard linings and suspended soffits. The various elements in sheet steel and fixed glazing added to the facade serve to extend the internal space. The prefabricated supporting construction was fixed to the existing structure with injection dowels.

<http://www.detail-online.com/inspiration/school-of-art-in-paris-107401.html>



Case 06 – Housing + Commercial Block

Location: Rathenow (Germany)
Year: 1997

Description: the existing front half of the building was rehabilitated as residential. The back half of the building received an addition of 12 prefab containers. Material include reinforced concrete, corrugate aluminium panel/sheeting, steel frame, stainless steel hardware, glass and insulated wall and roof panels. The prefab containers are assembled with sanitary, under-floor heating system, electrical, plumbing and communication services. The process of assembly involves preparing the existing building to receive the structures and to allow for services to be plugged in.

<https://issuu.com/neuarchitecture/docs/prefabcity/188>

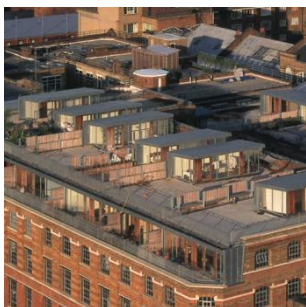

Case 07 – Shepherdess walk rooftop suburbia

Location: London (UK)
Year: 1999

Rooftop pavilions set in a garden landscape. The developer wished to create a mixed use building combining residential and commercial units. A transformation has most obviously been effected in the courtyard and in the invention of a roofscape. Constructed with standard steel sections this skeleton supports new circulation, a lift tower, balconies and rooftop pavilions. The loft apartment, this most urban of living conditions, is transformed by the invention of suburbia on the roof.

http://hhbr.co.uk/wp-content/uploads/2014/02/Shepherdess-Walk_Pamphlet.pdf



Case 08 – Triade Culture education centre

Location: Den Helder (The Netherlands)
Year: 2001

Triade is an art education centre providing classes and workspaces. The school's extension and renovation includes two stories of classrooms and studios. For maximum cost savings and building efficiency, the extension makes shared use of the existing corridor, bathrooms, and stairwell. This wing is sheathed in steel with a traditional wood and bitumen roof elegantly camouflaged by a layer of western red cedar to protect it from ultraviolet light and direct heat. All existing building is overlap with a new glass façade and wood roof.

<http://search.nl/#/content/triade>

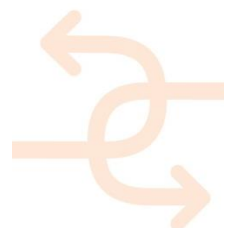



Case 09 – Minister of Cultural and communication

Location: Paris (France)
Year: 2004

The wonderful Royal Palace is near the beautiful Vero-Dobat passage also, but the city at the crossroads of the cross-des-Petits-Champs street does not display his finest facades. The Ministry of Culture has decided to set out all its directions, to propose an architecture that is also its image. This lightweight jacket is unusual and one corner of the new ministry. Ministry offices have a new building façade realized with steel structure and glass. New building façade is linked to the historical wall.

<http://soler.fr/projet/les-bons-enfants/>
<http://www.druot.net/bonsenfants.htm>



Case 10 – Reconversion of water tower

Location: Brasschaat (Belgium)
Year: 1999

4-metre-high cylindrical water tank raised on four 23-metre-high columns, with three square intermediate platforms 4x4 m in size. At the base is a plinth structure that originally contained filter plant and a reservoir.

The plinth and tower have now been completely refurbished and converted into a house. The tower has been enclosed in glazed walls, consisting of U-section glass elements on three sides and a clear-glass facade to the south. The visible concrete structure of the tower is complemented by elements in steel and glass.

<http://www.crepainbinst.be/portfolio/water-tower-brasschaat/>



Case 11 – Museum Alf Lechner

Location: Ingolstadt (Germany)
Year: 2001

The building was redesigned to present the work of the steel sculptor Alf Lechner. It contains exhibition areas of 1,000 m² on the ground floor and 800 m² on the upper floor. The existing structure has been simply clad in aluminium on three faces. The north side, in contrast, was opened up, and a two-metre-deep steel-and-glass "showcase" structure was added, allowing views into the exhibition spaces. All internal fittings were removed.

<http://www.crepainbinst.be/portfolio/water-tower-brasschaat/>
<http://www.detail-online.com/inspiration/alf-lechner-museum-in-ingolstadt-107410.html>



Case 12 – 25 kV Re-use of a former transformer house

Location: Lloydstraa (The Netherlands)
Year: 2000

In recent years Schiecentrale, the former electricity generating plant on Lloydpier in Rotterdam, has developed into the centre of the creative industry of the city. Mei architects and planners turned the originally introverted and blank transformer house, which is part of Schiecentrale, into a transparent structure that houses various businesses: the 25kV building. The transparency of the new structure was achieved by removing the originally blank façade over the full length of the building. In its place is a steel frame faced entirely with glazed panels.

<http://mei-arch.eu/en/project-archive/25-kv-2/>

