

D6.1 Training modules and pilot training courses

ANNEX 2

Awareness training INSITER and quality assurance



D6.1 Training modules and pilot training courses
Annex 2 – Awareness training INSITER and quality assurance

INSITER - Intuitive Self-Inspection Techniques using Augmented Reality for construction, refurbishment and maintenance of energy-efficient buildings made of prefabricated components.

This research project has received funding from the European Union's H2020 Framework Programme for research and innovation under Grant Agreement no 636063.

Colophon

Copyright © 2018 by INSITER consortium

Use of any knowledge, information or data contained in this document shall be at the user's sole risk. Neither the INSITER Consortium nor any of its members, their officers, employees or agents accept shall be liable or responsible, in negligence or otherwise, for any loss, damage or expense whatever sustained by any person as a result of the use, in any manner or form, of any knowledge, information or data contained in this document, or due to any inaccuracy, omission or error therein contained. If you notice information in this publication that you believe should be corrected or updated, please contact us. We shall try to remedy the problem.

The authors intended not to use any copyrighted material for the publication or, if not possible, to indicate the copyright of the respective object. The copyright for any material created by the authors is reserved. Any duplication or use of objects such as diagrams, sounds or texts in other electronic or printed publications is not permitted without the author's agreement.

This research project has received funding from the European Union's H2020 Framework Programme for research and innovation under Grant agreement no 636063.

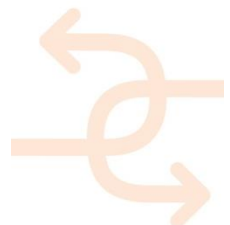

Contents

1. AWARENESS TRAINING INSITER AND QUALITY ASSURANCE	7
1.1 Introduction	7
1.2 What is INSITER?	7
1.3 What is quality assurance?	8
1.4 Multiple choice question: What are three objectives of quality assurance? – choose the correct answer	9
1.5 What is the importance of quality assurance?	9
1.6 Which of the following statements are true?	9
1.7 Relationship between quality assurance and the building	9
1.8 Building quality	9
1.9 Multiple choice question: What could be consequences of poor quality of the building envelope? – choose the correct answer	10
1.10 Capture building quality	10
1.11 Building installations	11
1.12 Fill in the blank spaces in the following sentence:	11
1.13 Monitoring	11
1.14 Multiple choice question: What are the actions during monitoring in order to keep the building functioning properly? – choose the correct answer	12
2. PROCESS CHANGES	13
2.1 Appointments and coordination	13
2.2 Building dossier	13
2.3 Fill in the blank spaces in the following sentence:	13
2.4 Consequences of the building dossier	14
2.5 What is the most practical way to store information and the building dossier?	14
2.6 Change of responsibilities	14
2.7 Multiple choice question: What kind of shift of responsibility takes place due to quality assurance? – choose the correct answer	15
3. FROM INSTRUCTION TO SELF-INSTRUCTION IN INSITER	16
3.1 From instruction to self-instruction	16
3.2 Self-instruction at INSITER	16
3.3 What benefits arise from self-instruction by the user of INSITER?	17
3.4 Project Hogekamp Enschede	17
3.5 By using prefab components:	18
3.6 Installing façade elements	19
3.7 What is the advantage of using a QR code or RFID chip on a façade element?	19
3.8 Thermal bridge	20

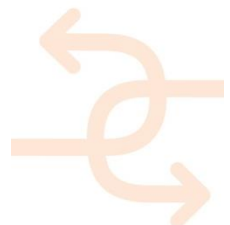

3.9	Fill in the blank spaces in the following sentence:	22
3.10	Airtight construction	22
3.11	Which of the following statements are true?	23
3.12	Thermographic examination of the building façade	23
3.13	Design and mounting installations	24
3.14	What is prevented with clash detection?	25
3.15	Augmented Reality	25
3.16	Self-instruction competencies	25
3.17	Match the competences with the properties	26
4.	FROM INSPECTION TO SELF-INSPECTION	27
4.1	From inspection to self-inspection	27
4.2	By whom is a self-inspection supposed to be carried out?	27
4.3	What is self-inspection?	27
4.4	Self-inspection techniques	28
4.5	The image below shows how insulation should be applied at a corner. Is the appliance of insulation executed correctly?	28
4.6	The importance of self-inspection	28
4.7	What are the traditional failure costs in construction projects?	29
5.	INSPECTION AND MEASUREMENTS	30
5.1	Various inspection techniques	30
5.2	Thermographic scan	30
5.3	What are the possibilities of a thermographic photo?	32
5.4	Select the thermal bridge in the image	32
5.5	3D laser scanning	32
5.6	What is possible with a 3D laser scan?	33
5.7	Experiments with different 3D laser scans in INSITER	33
5.8	Humidity measurement	34
5.9	Blowerdoor test	35
5.10	How is the blowerdoor test executed?	35
5.11	Smoke test	35
5.12	Ultrasonic scan	36
5.13	How many devices are needed for the ultrasonic scan to measure the sound density of a building?	36
5.14	SoundBrush	37
5.15	Fill in the blank spaces in the following sentence:	37
5.16	Microphone array	37
5.17	What is the disadvantage of the microphone array compared to the SoundBrush?	38
5.18	Thermography at the factory	38
5.19	Ventilation flow measurements	39
6.	CHANGES THROUGH SELF-INSPECTION	40

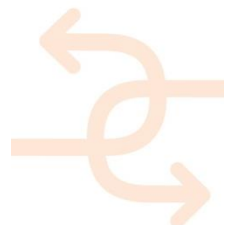

6.1	New actions through quality assurance	40
6.2	Role of the designer	41
6.3	What are the responsibilities of the designer?	41
6.4	Role of the work planner	41
6.5	Fill in the blank spaces in the following sentence:	42
6.6	Role construction and MEP worker	42
6.7	What are the most important tasks of the construction or MEP worker with self-inspection?	42
6.8	Self-inspection competencies	42
7.	WHAT DOES INSITER DO?	43
<hr/>		
7.1	Introduction	43
7.2	In the image below the marking on the road around a branch is made. Who is responsible for this error in this situation?	43
7.3	What is BIM?	44
7.4	Choose the correct answers to fill in the blank: What are the three main functionalities of a BIM?	44
7.5	INSITER BIM & AR	44
7.6	QR code	44
7.7	Structure of INSITER	45
7.8	Self-inspection with INSITER	45
7.9	Inspection protocols	45
7.10	Mobile inspection applications	45
7.11	INSITER inspection application	46
7.12	Other inspection applications	46
7.13	Data integration in INSITER	47
7.14	Consequences BIM	47
8.	TRAINING 8-STEP INSITER METHODOLOGY	48
<hr/>		
8.1	Introduction 8-step INSITER methodology	48
8.2	Step 1: Mapping	49
8.3	Step 2: Self-inspection during purchasing, production and delivery and checking of prefab ordered components.	50
8.4	Step 3: BIM for on-site construction	51
8.5	Step 4: Create and deploy BIM-based AR (Augmented Reality) in a project for self-instruction and self-inspection	52
8.6	Step 5: Test AR on-site for visual comparison between BIM model and realisation based on visualisation of virtual clashes / inconsistencies.	52
8.7	Step 6: Self-instruction during the preparation and logistics of the construction site and during construction.	55
8.8	Step 7: Self-inspection during construction, refurbishment and maintenance	55
8.9	Step 8: Final check	57
9.	EXAMPLE OF PRACTICAL USE OF INSITER GUIDELINES ACCORDING TO THE 8-STEP	

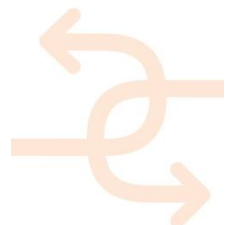

METHODOLOGY	58
10. SUMMARY	61

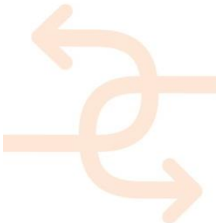

1. Awareness training INSITER and quality assurance

1.1 Introduction

Buildings need to be designed and built ever more energy-efficient. Building parts are produced more and more in an industrial way. As a result, the use of prefab elements in construction will grow. The contractor who realizes the building will be increasingly responsible for the final quality and energy efficiency of the building. This quality must not only be improved, but also guaranteed.



This training specifies what information and instruments are available for quality assurance. The experiences gained in the INSITER research project are also being used to further quality improvement.

In this training, information is interspersed with short questions. Multiple answers will be possible. After answering the questions, you will be asked whether you have mastered the information or if it is recommended to go through the training again.

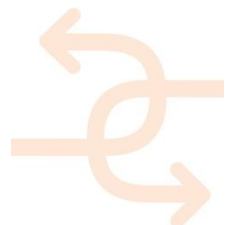

Figure 1: INSITER

1.2 What is INSITER?

INSITER is a European research project with the aim to develop intuitive affordable tools for self-instruction and self-inspection with the help of Augmented Reality (AR) and BIM.

The main question for INSITER is: How can quality assurance be efficiently organized, in such a way that:



1. quality increases;
2. failure costs are being reduced, and;
3. realization costs remain within the limits?

INSITER aims to close the gap between design and realization. By bringing self-instruction and self-inspection to the worker on site/ craftsmen, INSITER will improve the quality and energy efficiency of the building.

Hypothesis of execution during construction:

1. The benefits from using energy-efficient building components are lost due to lack of knowledge or information, resulting in incorrect fitting during the construction process. This affects the final performance of the building.
2. The construction sector is characterised by a segmented approach involving a variety of skills and expertise with different roles and responsibilities. During construction, each (sub-) contractor must ensure that its contribution fits into the overall quality framework, defined collectively at the design level.

1.3 What is quality assurance?

Quality assurance is the check and demonstration of the quality delivered in a project. The aim of quality assurance for contractors is risk management: reducing failure costs and increasing customer satisfaction. For the customer the result is a building with better quality and fewer defects and in accordance with the agreed performance.

With increasing demands on building performance, quality assurance is becoming more and more important. It is necessary to limit the energy consumption in the building environment, but also to increase indoor environmental quality. Physical problems such as high humidity and mould formation should be prevented.



1.4 Multiple choice question: What are three objectives of quality assurance? – choose the correct answer

- Preventing damage
- Increasing customer satisfaction
- Reduce failure costs
- Arranging liability
- A qualitatively better building

1.5 What is the importance of quality assurance?

The sustainable future of the building environment is accompanied by improved construction architectural detailing and new techniques. Consider, for example, a heat pump or prefabricated wall parts that have to be connected airtight. If the contractor cannot apply the innovations properly, the intended sustainability will not be accomplished. The customer does not get what he requested and the contractor risks failure costs and a dissatisfied customer.

Quality assurance helps the contractor to build better. By identifying the risks in advance and by defining the required quality checks during project preparation, errors or deviations during construction can be prevented. This improves the quality of the final building and ensures that the intended 'sustainability' is also realized.

1.6 Which of the following statements are true?

- Sustainability is the key to better quality assurance during construction.
- Quality assurance is the key to the realization of the required sustainability.
- Sustainable development is accompanied by improved architectural detailing and new techniques.
- Quality assurance is about detailed inspections after the construction phase.

1.7 Relationship between quality assurance and the building

The qualitative and energetic performance of a building depends on building and installation-technical aspects. If one of the two malfunctions, the whole building does not perform as-required. The quality of both the architectural and installation technical elements is therefore important for the comfort and energy efficiency of the entire building, also the interconnection between these two. After all, a well-insulated airtight building requires a well-performing ventilation, cooling and heating installation.

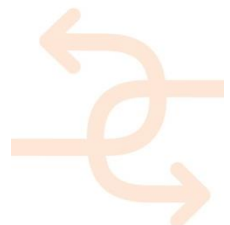

The constructional quality of a building is about the building envelope, the foundation, construction and the inner walls. This involves bricks, concrete walls, windows, roofing systems, etc. Consequently, there are a large number of architectural elements that can influence the comfort and energy efficiency of a building.

For example, if there are cracks in the building envelope or if insulation is not properly installed, thermal bridges and air drafts can arise. As a result, the energy efficiency and comfort of the building cannot be assured. The different elements of the building envelope must therefore be of the right quality, matched and correctly applied.



1.9 Multiple choice question: What could be consequences of poor quality of the building envelope? – choose the correct answer

- Poor air quality due to thermal bridges
- Energy-efficiency because of cracks
- Condensation and mould forming due to thermal bridges
- High heat loss due to poorly applied insulation

1.10 Capture building quality

The construction quality is documented with a closure form. All architectural components and installations are present and checked on the form. It is necessary to follow the procedure of finalising, for example, a wall may only be closed when all parts have been signed off on the closure form. The signed closing form is digitally recorded in INSITER.

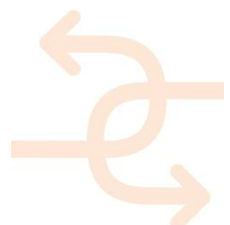

1.11 Building installations

Without building installations, the comfort in the building will not meet the requirements, even though the building is well insulated. Installations that have the highest influence on energy performance and indoor environmental quality are heating, cooling, ventilation, lighting and domestic hot water systems. Defective installations in a building often have annoying consequences for the customer. Not only the energy bill is much higher, but also health and comfort complaints arise. Installations must be carefully designed, matched and properly installed to ensure the final performance of the building.



1.12 Fill in the blank spaces in the following sentence:

The quality of a building architectural and installation aspects. The appliance of architectural elements and installations therefore has to be ... and fitted to ensure the final performance of the building.

Depends on - is worsened by - is improved by - well-manufactured - well coordinated - delivered according to plan.

1.13 Monitoring

Monitoring is the measurement, comparison, analysis and reporting of the energy use of a building. In addition to the energy consumption, other performance indicators, such as temperature or CO2 content, can also be monitored. A building that is perfectly delivered on delivery will not be as energy efficient or comfortable over time. The purpose of monitoring is to maintain and optimize the performance and quality of the building. Therefore, maintenance should be performance-driven and adjustments must be made based on energy use analyses.

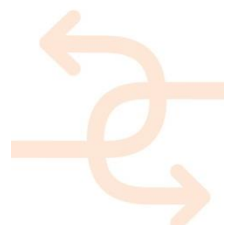

1.14 Multiple choice question: What are the actions during monitoring in order to keep the building functioning properly? – choose the correct answer

- Measure, plan, analyse and execute;
- Measure, compare, analyse and report;
- Measure, set, check and maintain;
- Only measure.

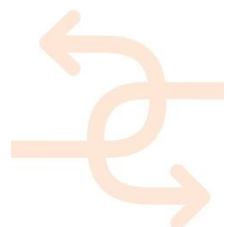

2. Process changes

2.1 Appointments and coordination

Quality assurance must be properly coordinated on forehand. Emphasis is on how the quality assurance is implemented, and what or who determines that the executed work is satisfactory and materials have been applied correctly.

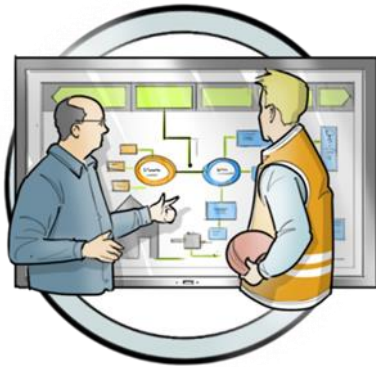

2.2 Building dossier

It must be clear on forehand what has to be recorded and how this must be addressed in the building dossier. The building dossier contains a description of the building, the architectural and installation data. It includes all information necessary for the control, maintenance and use of the building. For example the most recent revision drawings and appropriate user manuals. Also included in a good building dossier is information about the condition of installations, in order to make clear which parts need to be replaced when.

Important is that not only malfunctions are recorded, but also correctly functioning elements. The information collected can be useful for future projects. Therefore it pays off to include the quality checks in the building dossier and record it over time and give feedback to the relevant stakeholders.

But how do you know what information needs to be recorded? A useful tool is sort documents by importance. For example, by arranging them into:

1. Requirements regarding legislation and regulations;
2. Aspects regarding (financial) risks;
3. Decency standards regarding proper work.

2.3 Fill in the blank spaces in the following sentence:

... is important in quality assurance. The ... are recorded and saved in a building dossier.

- Making a clear inspection plan
- Inspect at a detailed level
- Recording all information
- Requirements regarding legislation and regulations
- Quality checks
- Risks

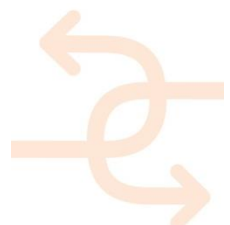

2.4 Consequences of the building dossier

The recorded inspection results will be collected in the building dossier which serves as proof of accepted work, and can be used to learn from in future projects. For example, if at any point during the use phase of the building unexpected errors occur, the building dossier can be consulted to help to find and solve the problem.

In INSITER the building dossier is digitally connected to BIM. This means that the building dossier in INSITER can be consulted and filled by a smart device when the site worker is at the building site.

Quality assurance thus, has an effect on how the building dossier must be filled. Because it demands a large amount of information to be stored, the dossier can become considerably large.

2.5 What is the most practical way to store information and the building dossier?

- Digital, because files can be very large
- On paper, because all information is collected on site

2.6 Change of responsibilities

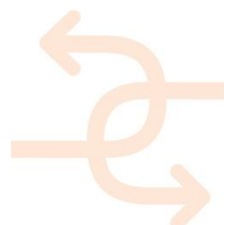

Quality assurance causes a shift in responsibilities. Because more information is recorded, more responsibility can be imputed to the contractor and less to the client. Afterwards, it can still be checked carefully where the possible mistake is made and who is responsible for it. It's not enough if the contractor can prove that he has undertaken the right actions., He will ~~not~~ be blamed. In the Netherlands the contractor stays responsible for the result. The responsibility might be different in other European countries.

Recording in the building file takes more time and therefore more money. On the other hand, failure costs are lower because errors or shortcomings are more likely to become clear and solved with less problems at an earlier stage. The total costs of a project can be reduced considerably. And it is therefore important to organize the quality assurance as effectively as possible.

2.7 Multiple choice question: What kind of shift of responsibility takes place due to quality assurance? – choose the correct answer

- From user to the contractor
- From client to the contractor
- From contractor to the client
- From contractor to the user

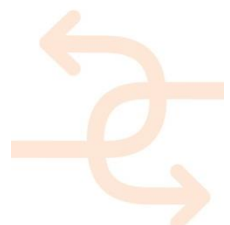

3. From instruction to self-instruction in INSITER

3.1 From instruction to self-instruction

Traditionally, instructions to the construction worker are given on forehand at the building site when the construction worker starts his work. Apart from these instructions there are instruction manuals available. Work instructions for safety are written and explained in the quality system. Using a smart phone to watch an instruction movie about construction and safety or taking a photo of the finished work is much more common nowadays. In addition, self-instruction ensures that the methods used to fulfil the project are healthy and safe. Employees at the work spot are protected against accidents as a result of ignorance or poor workmanship.



3.2 Self-instruction at INSITER

With INSITER, much more use is made of the possibilities offered by a smartphone or tablet. The construction worker can prepare for the work he is ordered to do, with the following self-instruction tools on his tablet or phone:

- Guidelines and instructions;
- Videos;
- 3-D drawing of the building (BIM).



In addition to these tools, INSITER's AR (Augmented Reality) module (MS HoloLens) is used in combination with the BIM model. The BIM model is visualized in INSITER's AR module. It's a visual guide in which the building elements and installations can be compared between the virtual BIM model and the real on-site situation.

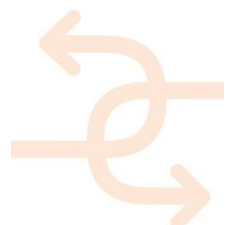

3.3 What benefits arise from self-instruction by the user of INSITER?

- The construction worker receives a detailed instruction from the work planner on forehand.
- The construction worker has all work instructions digitally available on his working spot.
- The BIM model is available for the construction worker.
- The construction worker can consult the drawings via a tablet or smartphone.

3.4 Project HogeKamp Enschede

In the INSITER project, the HogeKamp building from 1965, located at the University of Twente, was used as a demonstration case. The building is an abandoned university building which is being converted into student apartments (75%) and a hotel (25%). It was estimated that implementation of prefab solutions for the building's envelope and HVAC systems (Heating, Ventilation and Air Conditioning) and making use of the embodied energy can provide energy saving reaching 70% compared to the situation before the renovation. The prefab solutions, including façade elements but also kitchen units and sanitary modules, will allow 50% time saving in the renovation process.

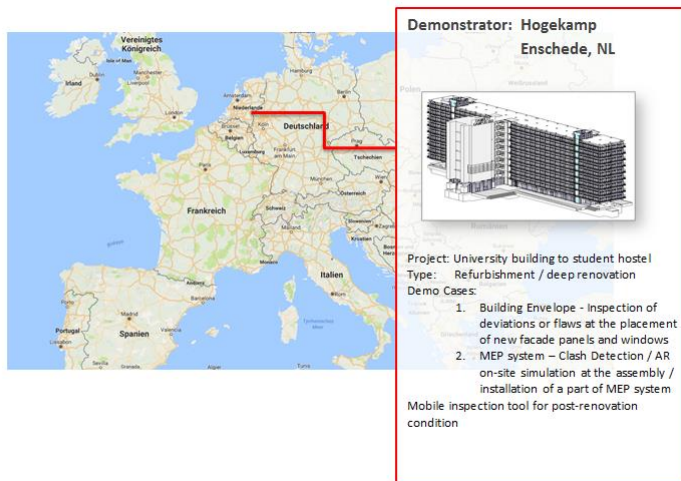
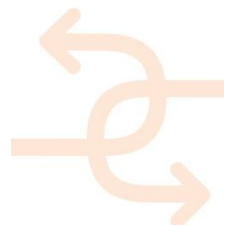

Figure 2: HogeKamp demonstration Case Enschede



Figure 3: HogeKamp building as-built in 1965 and after renovation in 2018



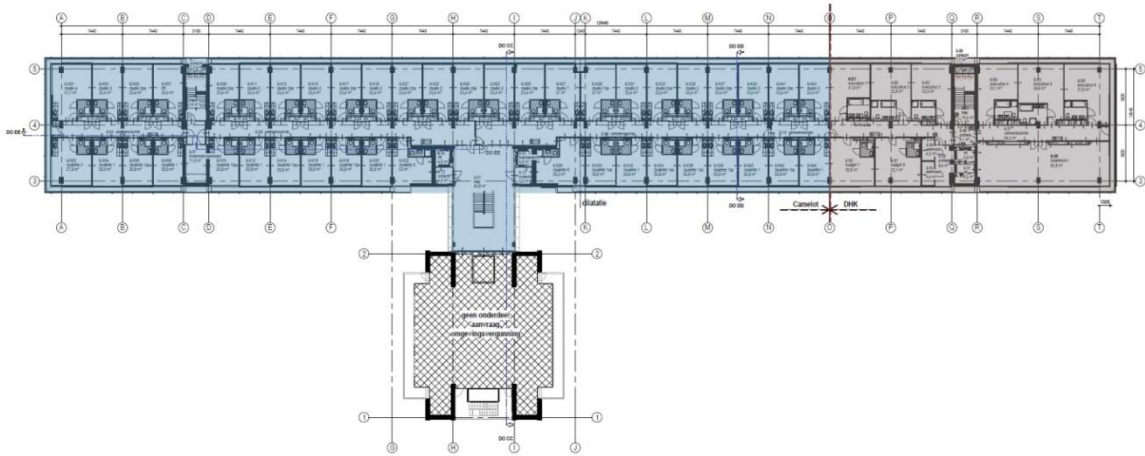

Figure 4: Floor plan of 1st-9th floors including division into the student housing (Camelot) and the hotel (DHK)

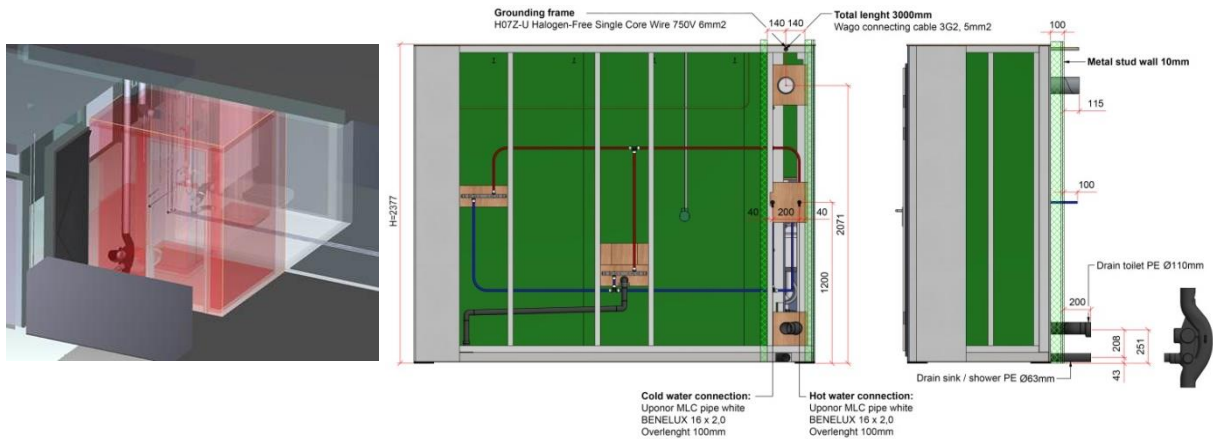
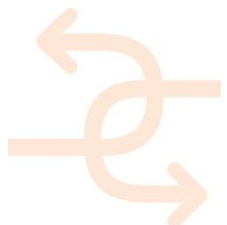

Figure 5: Targeted to-be situation as BIM illustration images and detail of the bathroom unit

3.5 By using prefab components:

- 70% energy is saved and construction time is reduced by 50%, for a university building;
- the construction time is reduced by 50%, for a renovation building with student housing;
- 70% energy is saved, for a new building with student housing.



3.6 Installing façade elements

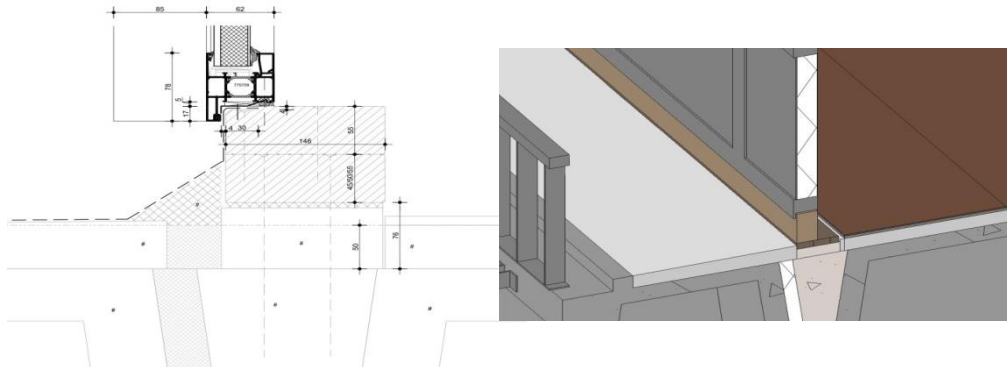

Figure 6: The level of detail of the BIM model on the example of the section of the window frame

In the project HogeKamp the façade of the building is fitted with aluminium façade elements with energy-efficient glass. Aluminium is a strong and relatively light material, making it ideal for use in a façade panel. The aluminium façade panels are placed in a wooden frame. The facades have been developed in the 3D BIM architectural model. 3-D models are very detailed, but the smaller elements, such as locking plates, fastening and sealing materials are not shown in the 3-D model.

The façade elements that are delivered on the site are provided with a QR code or RFID chip. At the start of the work, the construction worker scans the QR code, using the INSITER tool on a tablet. The 3D BIM model then opens automatically on the tablet. In the model, the panel is highlighted and the construction worker sees directly whether the facade element is in the right place.

The dimensions and relevant specifications of the façade elements are compared with design from the 3D BIM model.



Figure 7: Comparisons between real live situation and the BIM model: general outside and inside views on the façade panels

3.7 What is the advantage of using a QR code or RFID chip on a façade element?

- Via the INSITER app on the tablet it becomes directly visible in the BIM model if a façade element is located in the right room.
- All parts are visible in the 3-D BIM model.
- The actual situation can be compared to the situation in the model.

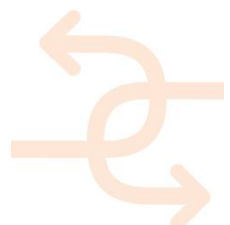

INSITER D5.4; data sheet use case					
Use Case 1.1		Scan of QR code			
Relevant Demonstrator	Health Centre Cologne				
Responsible Insiter Parter	3L				
					
	description	responsible partner	additional input	time schedule	tools to be used
Step 1	create BIM Model	3L/HVC	Panel producer	done	IFC viewer
Step 2	upload BIM to server	HVC	n.a	done	n.a.
Step 3	production of panels	3L, panel producer	n.a	contracted	
Step 4	inform site of date panels will be ready	3L, panel producer		pending	
Step 5	upload all relevant information to server	3L, panel producer			INSITER guidelines
Step 6	transportation of panels to site	panel producer	transport company		
Step 7	scan QR code	assembler			QR code scanner
Step 8	check and report quality of panels	assembler			INSITER software tool

Figure 8: Example INSITER Scan of QR code in another INSITER project, a health centre in Cologne, Germany

After scanning the QR-code the construction worker at the health centre in Cologne knows that all the materials of the wooden façade elements are at the right spot in the building

At the start of the work the following video can be viewed by the construction worker (example HogeKamp):

<https://www.youtube.com/watch?v=QNMMyUNRpYjE>

The construction worker starts building the façade panels. The connection points between the façade panel, built-in panels and the building are indicated on the following picture:

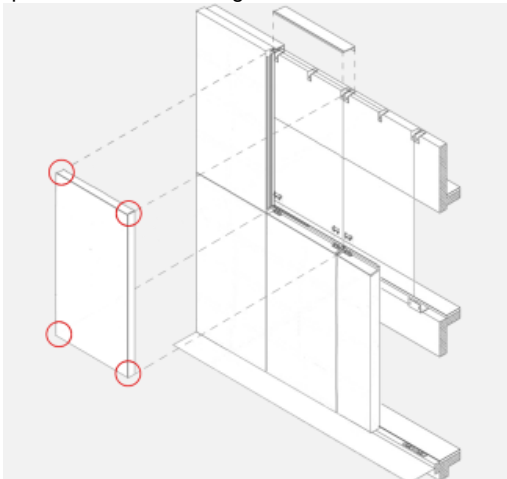
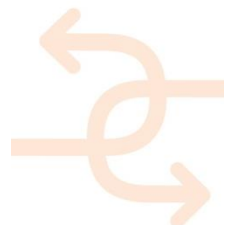

Figure 9: Connection of façade panels

3.8 Thermal bridge

In the case of new construction, but especially in the case of renovation, (for example HogeKamp) a thermal bridge is a weak point of the façade. A lot of energy can be lost through a thermal bridge. The insulation of a building separates the



indoor climate from the outdoor climate. With a thermal bridge, the insulation layer has been broken, which causes heat loss and therefore more energy is needed to heat the building. It also increases the chance of condensation and mold growth.

Examples of thermal bridges are:

- an insulated wall with a floor construction, in which the concrete floor is in direct contact with the outside leaf of the insulated cavity wall;
- the concrete of the balcony is in direct contact with the concrete floor of the heated room;
- connection from the insulation of the wall to window- and doorframes.

Examples of testing results in the INSITER project:

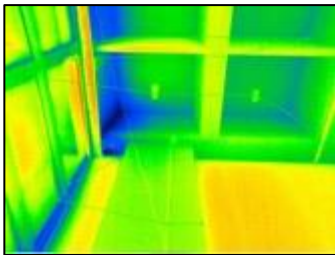

Figure 11: Thermal bridge in the corner of the ceiling



Figure 10: Picture of the corner of the ceiling

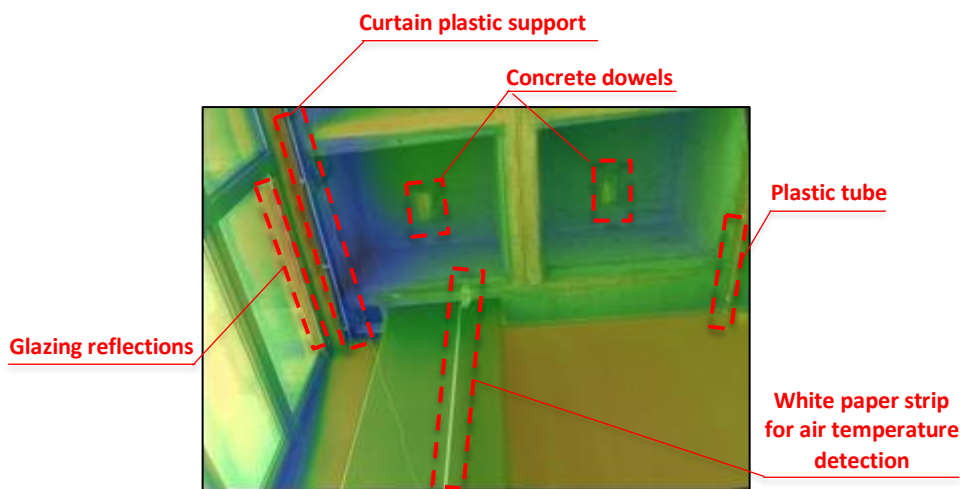

Figure 12: IR & Visible images overlapped



Figure 13: Visible image



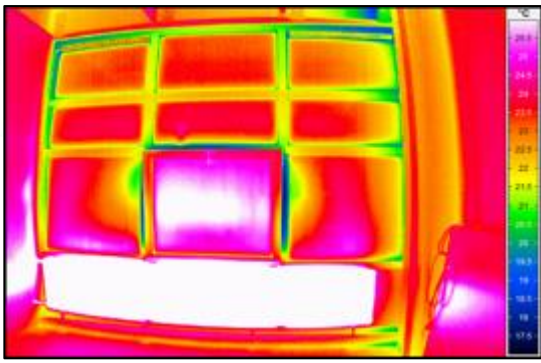

Figure 14:

1. Loss of insulation on the left and right metal shutter
2. Window open that simulates a thermal bridge in the sealing



Figure 16: Visible image with leaks

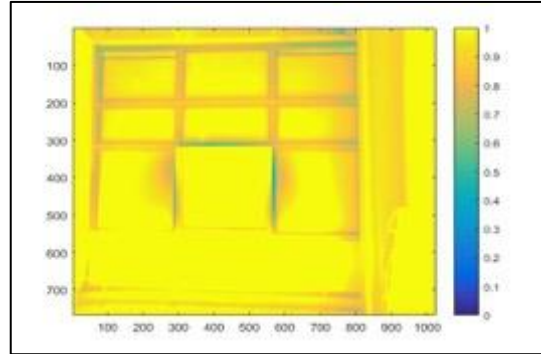

Figure 15:

1. Thermal anomaly in the right corner of the ceiling. TI value lower than 0,75
2. Thermal anomaly on the left and right metal shutter. TI value lower than 0,75

3.9 Fill in the blank spaces in the following sentence:

With a thermal bridge much ... can be lost and because the insulation layer is, mould is able to form.

Heat - broken - energy - not applied

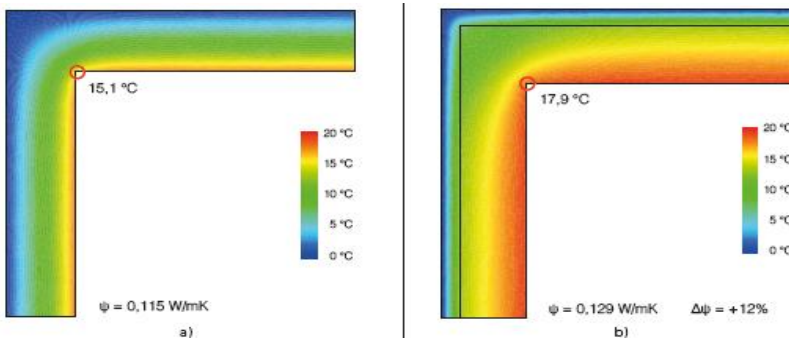

Figure 18: a) Thermal corner bridge between two uninsulated vertical walls. b) Angular thermal bridge between two exterior walled vertical walls (modified solution).



Figure 17: Simulation performed with the TerMus-PT version 6.00a software

3.10 Airtight construction

In addition to the prevention of thermal bridges, the air tightness of the façade must be limited. Energy can be lost due to a non-airtight facade. Besides limiting energy loss, there are more reasons for an airtight construction:

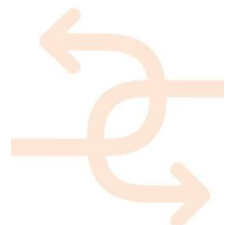

- reduce drafts, and subsequently increasing comfort;
- preventing damage from moisture;
- improving the water tightness and sound insulation.

The guidelines for airtight assembly of the façade elements are being studied by the construction worker on the tablet.

Example of using INSITER for self-instruction and self-inspection of the façade panels at HogeKamp:

<https://www.youtube.com/watch?v=JcjHUqYEUxA&feature=youtu.be>



After installation of the façade elements, the construction worker checks his work visually with the help of checklists or by means of inspection protocols on the tablet through self-inspection. The construction worker makes a number of photos with his smartphone, which are added directly to the building dossier in INSITER. The inspected elements are identified by QR or RFID code and connected to the BIM model of the building dossier with a GUID code. The site manager checks the photos. Comments in case of questions are fed back and immediately processed.

3.11 Which of the following statements are true?

- The construction worker checks his work visually and goes directly to the site manager if something is wrong.
- The construction worker visually checks his work and reports deviations via the tablet.
- The photos taken are added to the building dossier in INSITER.
- The site manager checks the photos and has the deviations solved by another construction worker.

3.12 Thermographic examination of the building façade

When the outside walls are sufficiently closed, a thermographic examination takes place with an infrared camera. The difference between the indoor and outdoor temperature must be at least 10 degrees. A setup in INSITER demonstration project HogeKamp is shown below.

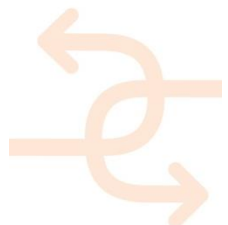

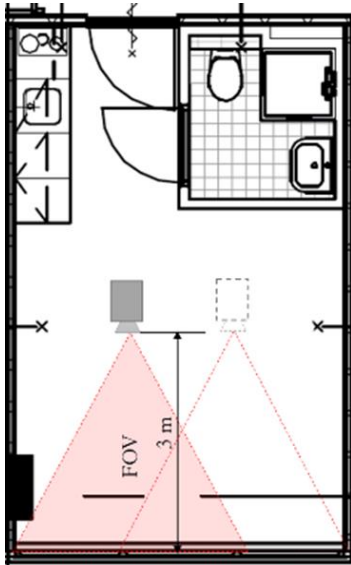

Figure 19: Room 1.K38 with area of 20.6 m2 and size 3575 x 5772 x 3.3 m

3.13 Design and mounting installations

The building will be equipped with new installations. All installation systems are drawn in the 3D BIM model. So-called clash detections will be executed by the designers.

What are clash detections: Clash detections are clashes between the various building and installation components.

Multiple components are then drawn in the same place. For example, water pipes go through a wall where this is not possible, heating pipes collide with cable trays or construction beams, etc.

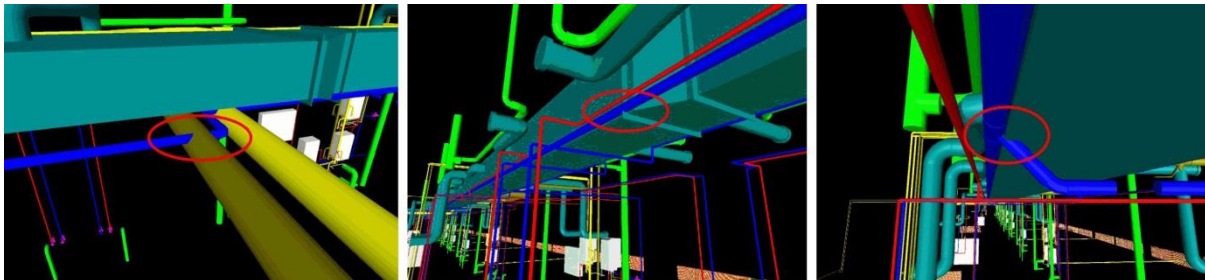
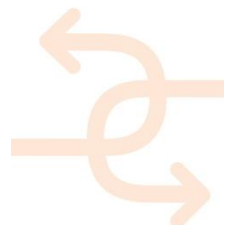

Figure 20: Examples of detected clashes in the DCS (Design Coordination System)

These collisions can also be checked manually by the designers, e.g. in a coordination meeting. All designers must then be present. This takes a lot of time and most of the time not all collisions are solved. It is also possible that the design changes at a later stage, so that these manual sessions have to be redone.

Clash detection when designing in the BIM model at the office prevents human errors at the building site. It is needed because different installations and constructions are included in a 3D model. Clash detection in the design prevents installations from being demolished during construction and the need to reassemble at a different location. In the past some of these errors would only be discovered during construction, even after all the previous coordination between the designers. The clash detection prevents high costs and delays in the work.



3.14 What is prevented with clash detection?

- The cable tray and central heating pipes are drawn and assembled at the same location
- Coordination meetings between the designers
- Water pipes are designed at the right position. They remain easily accessible, for example in case of leakages
- High costs and delays for the builders when installations need to be changed or be rebuild

In the INSITER demonstration project HogeKamp the BIM 3D model is visualised in combination with Augmented Reality (MS HoloLens glasses).

3.15 Augmented Reality

Augmented Reality (AR) is real-time integration of digital information with the user's environment. In contrast to virtual reality, which creates an artificial reality, augmented reality - literally translated: "enriched reality" - uses the existing environment and enriches it with a digital information layer.

Augmented reality works for example with the MS HoloLens.

Using Augmented Reality with the HoloLens is as follows:

With the HoloLens you stand in place and see which installations have to be installed where. A final clash detection with clash cubicles also takes place. The construction worker sees for example that there is still a cable tray running through other installation components. The heating engineer can contact the designer(s) directly. The collision is quickly resolved and the MEP worker can continue his work instantaneously.

This movie shows how the HoloLens is used in INSITER demonstration project HogeKamp:

- HoloLens BIM based Mixed Reality App: https://youtu.be/hJwOjPe_s1Y

3.16 Self-instruction competencies

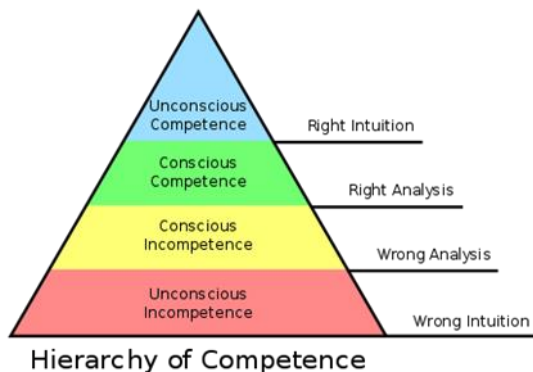

In self-instruction, the knowledge and skills of the construction worker revolve around four competency layers:

1. *Unconsciously incompetent:* The construction worker does not understand or does not know how to do something and does not see the shortcomings of his work.
2. *Consciously incompetent:* Although the construction worker does not understand or knows how to do something, he recognizes the shortcomings of his work, as well as the value of new skills to address his shortcomings.
3. *Consciously competent:* The construction worker understands and knows how to do something, but has to keep his mind on his work.

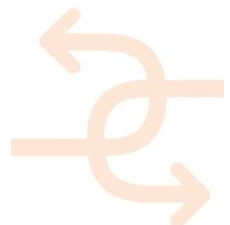

4. *Unconsciously competent.* The construction worker has practiced so much with his skills that it has become a 'second nature' and can therefore carry out the tasks with ease.

3.17 Match the competences with the properties

Match the skills with the properties.

Unconscious incompetence - Does not recognize mistakes and acts to the best of his knowledge

Conscious incompetence - Recognizes mistakes but does not know how to deal with them

Conscious competence - Recognizes mistakes and knows how to solve them

Unconscious competence - Recognizes mistakes and can solve them quickly

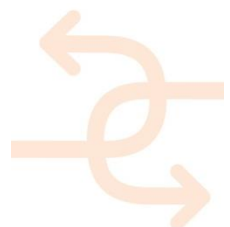

4. From inspection to self-inspection

4.1 From inspection to self-inspection

Traditionally, inspections are often carried out by an independent party and only after realisation of subsections or at the end of the entire construction process. Think of air flow measurements after a ventilation system has been fully installed, or performing a thermographic scan after the building is finished. In the case of self-inspection, the contractor carries out inspections himself. The self-inspections take place during or just after completion of a task and can be carried out by the construction worker himself or by a contracted inspector. Because the quality is checked and recorded before the construction or installation component is concealed, the requirements can be met much more effectively.

The self-inspections identify construction errors early in the process, which gives the opportunity to correct the possible errors at an early stage. This prevents failure costs in the construction process.

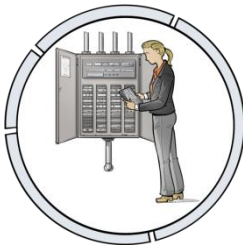

4.2 By whom is a self-inspection supposed to be carried out?

- An inspector, employed by (or hired by) the client
- An inspector, employed by (or hired by) the contractor
- An engineer from the architectural firm
- A construction worker from the contractor
- A MEP worker from the subcontractor
- A control technician from the subcontractor

4.3 What is self-inspection?

Self-inspection is a method where someone checks the work he has done himself.

Self-inspection is useful in processes where the executor of the process is not able to oversee the consequences of any errors made. The inspections are carried out based on a specific (inspection) protocol, to prevent errors and to standardize the process.

Self-inspection serves to check the quality of the assembling work and the installation of components. It also helps to improve the quality competence level of the construction workers. Because they gain direct insight into the quality of their work, they become more aware of the result of their actions. Thus the checks on their own work contribute to raising the level of quality.

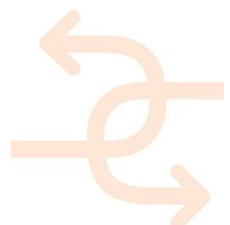

4.4 Self-inspection techniques

Self-inspection can be performed in multiple ways. A few examples are:

- by checklists,
- using photo material,
- by detail-comparisons,
- small measurements, etc.

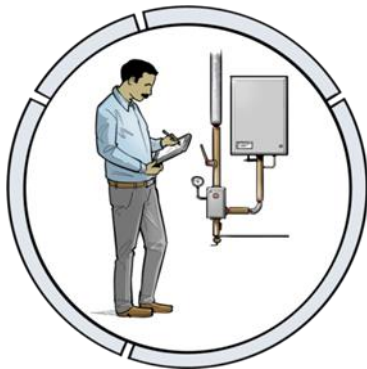

Each building technique has a need for its own specific inspection method. When checking insulation, for example, a photograph can be taken as proof for correctly applied insulation. And after fitting façade elements, an ultrasonic measurement can be used as proof that all the joints are airtight.

4.5 The image below shows how insulation should be applied at a corner. Is the appliace of insulation executed correctly?

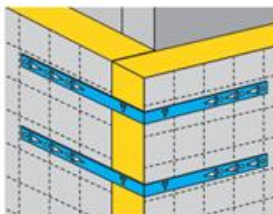

Een goede hoekverbinding is belangrijk. Steek de Isover isolatieplaten bij de omgaande muur door en snij vervolgens ter dikte van de isolatielaag af. Gebruik indien nodig hoekstrippen.



- Yes
- No.

Feedback:

The photo, a self-inspection technique, shows that the insulation is applied as in the example.

4.6 The importance of self-inspection

The added value of self-inspection is to reduce the gap between the design and the finished building quality. Self-inspection reduces costs by preventing rework and corrections afterwards. This reduces the costs of failure on a

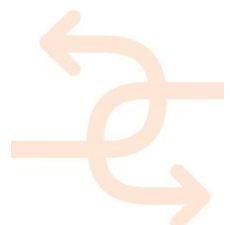

construction project, which is high in the traditional method of construction (Approx. 10%).

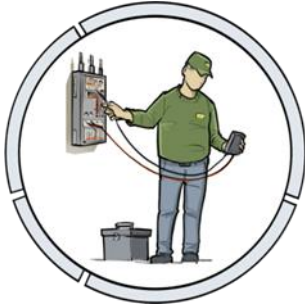

4.7 What are the traditional failure costs in construction projects?

- 5%
- 10%
- 15%
- 20%

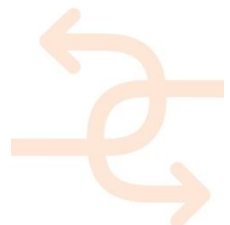

5. Inspection and measurements

5.1 Various inspection techniques

A few measurement methods that are being used during construction are:

- Laser scanning for right dimensions;
- Thermographic photos;
- Soundbrush inspections;
- Ventilation flow measurements;
- Etc.

Some of the techniques used for inspection are briefly introduced in the following blocks.

5.2 Thermographic scan

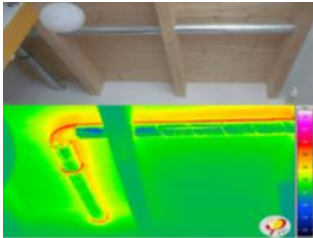

With a thermographic scan it can be checked whether the insulation has been applied properly and whether thermal bridges are present. Thermography is a method in which temperature differences of a building are being made visible by linking them to colours (blue is cold, red is warm).

Thermographic research uses infrared radiation. All objects emit a certain amount of infrared radiation depending on the temperature and the properties of the surface.

Essential for a thermographic investigation is that the difference between the indoor and outdoor temperature is at least 10 degrees. Therefore, these surveys are usually executed from between November and March. Because sunlight (radiation) also has an influence, the tests usually take place at night or early in the morning. When measuring from the outside, red (hot) areas reveal the heat leaks. Measured from the inside, the blue (cold) areas highlight a leakage or thermal bridge.

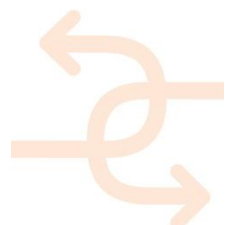



Figure 22: Position of thermal camera

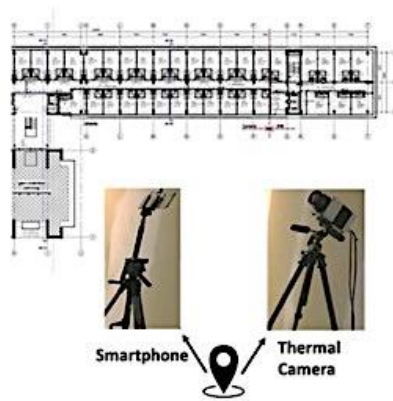

Figure 21: Equipment and plan



Figure 23: Hogekamp building Enschede

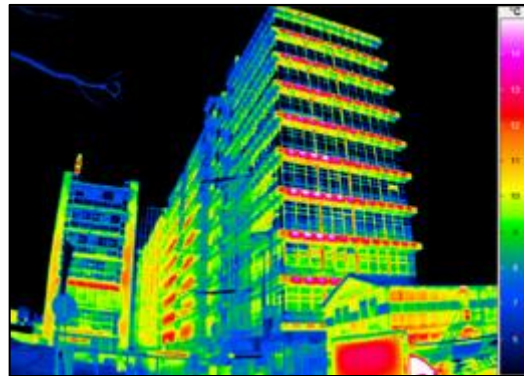
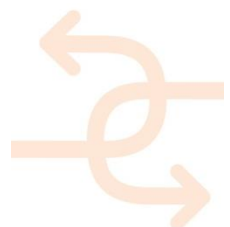

Figure 24: Thermal image of P1_East view Hogekamp



Figure 25: Visible image of P1_East view Hogekamp



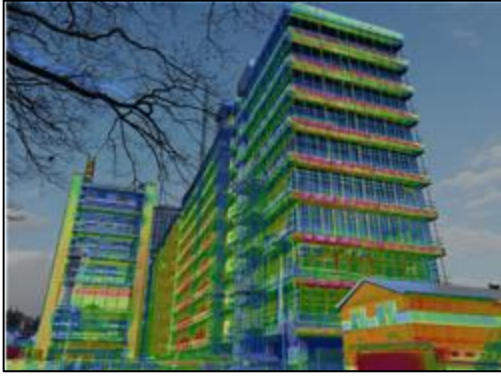

Figure 26: Thermal-Visio superimposition of external façade East view Hogekamp

5.3 What are the possibilities of a thermographic photo?

- Checking inconsistencies of insulation in the façade
- Determination of U values of the wall
- Determine the indoor temperature in a room
- Discovering air leaks in ventilation ducts
- Find thermal bridges in constructions

5.4 Select the thermal bridge in the image



5.5 3D laser scanning

3D laser scanning is a technique that makes it possible to record dimensions of existing buildings in detail. Objects are mapped by means of laser beams. Where the laser beam encounters an object, each beam makes a point in a 3D image plane. Together these points form a so-called 'point cloud'. By connecting the points together, the final image is created. The image is translated into a 3D image of the scanned object. With 3D laser scanning, a lot of measurements are made very quickly. In advance you have to think carefully about what you want to scan and why. Otherwise the model will be too big and is too complicated. So, only scan the objects, which you really need.

3D laser scanning is a valuable addition to BIM. A point cloud is not (yet) easy to translate to a BIM (Scan to BIM), because the files are very large. The laser scan can be used as a basic source material for renovation and for comparison with the new design to detect deviations. The point clouds are now copied by hand. In future a 3D laser scan will generate automatically a 3D BIM model (Scan to BIM).

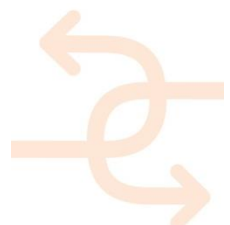



Figure 27: 3D laser scan

With a 3D laser scan it is crucial to make a lot of photos, which helps to create the overall picture.

The added value of 3D laser scanning and scan to BIM for renovation is:

- Not all parts have to be drawn always;
- You never have to go back to a building, because everything has been scanned;
- Drawing can be faster and cheaper.

5.6 What is possible with a 3D laser scan?

- Use the laser scan as a base for a BIM model
- Measure sound transmittance of the façade
- Capture buildings geographically in detail
- Measuring airtightness of window frames and façade parts

5.7 Experiments with different 3D laser scans in INSITER

In the INSITER project, experiments were carried out with various laser scanners at a building in Pisa, Italy and Valladolid, Spain. These experiments gave the following results:

- The scan time can be shortened.
- By using a linked tablet during the scanning, the results determine directly which parts should be scanned better.
- Different point clouds from the same equipment indicate that some point clouds can be more easily translated to BIM than others.
- By using smaller parts, such as walls only, deviations between the BIM model and the point clouds can be better mapped.

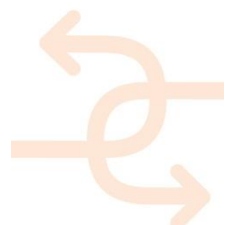

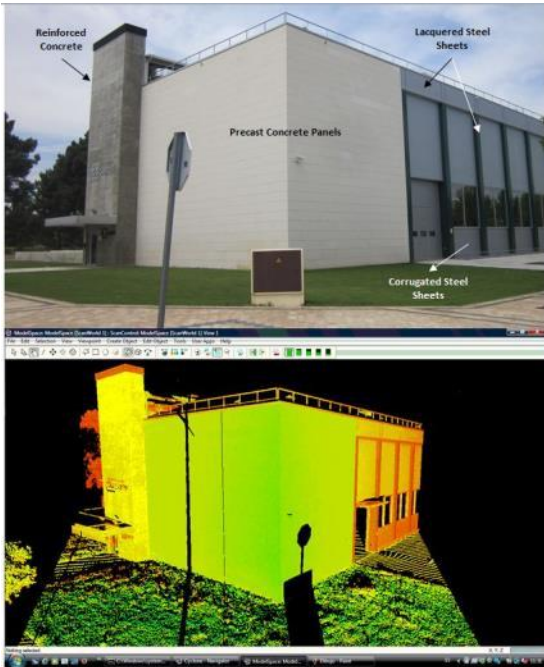

Figure 29: 3D laser scanning Cartif Building Valladolid

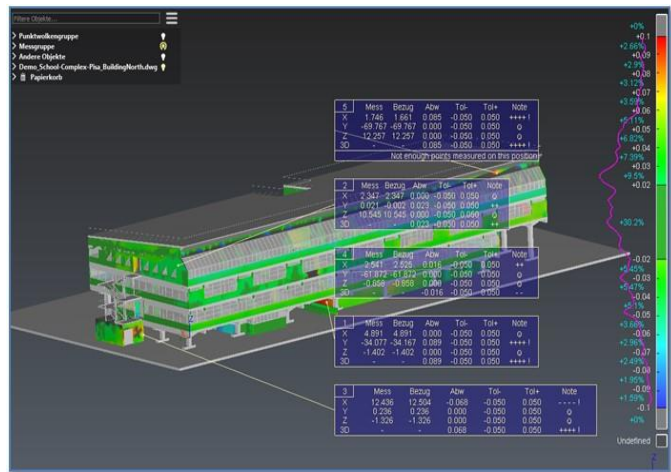

Figure 28: Results of 3D laser scanning

5.8 Humidity measurement

A damp building is unhealthy because of condensation and mould development. A high humidity is also uncomfortable because humid air feels cold. And finally, a humid indoor climate requires more energy, because more heating is required to heat up the humid air.

Moisture problems often only arise during the use of the building. Moist spots are visible through condensation or mould formation. Causes can be a thermal bridge, heat leak or a badly functioning ventilation system.

Humidity can be measured with a humidity meter. There are different types of moisture meters. Some are pricked into a wall and others are held against the wall. A moisture meter measures how much current passes through the wall. The more moisture there is in the wall, the better the wall conducts. A high score on the screen means a lot of moisture in the wall.

With a thermographic camera, damp spots in the wall can also be made visible. Moist and wet spots are colder than dry spots. On a thermographic camera the spots become green, blue, black and purple.

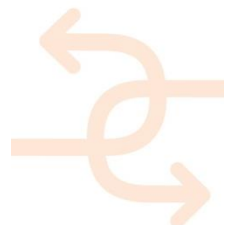



5.9 Blowerdoor test

The Blowerdoor test is an air permeability measurement or airtightness test.

With the blower door test all outside doors and windows are closed and all interior doors are open. The ventilation is switched off and the ventilation openings are closed. The blower is then placed in a doorway. The blower fan blows air into the building or sucks air out. Then the air pressure in the building is measured for a certain period of time. When the measurements show that too much air escapes (or is entered), then the airtightness is insufficient.

With the blower door test you can determine that there are air leaks. But of course you want to know where the air leaks are exactly. You can only find out by additional research, such as an ultrasound, infrared scan or a smoke test.

The measurement can take place at two moments. First is during the construction of the building, when the building is wind- and watertight and when all the services for airtightness are applied. This moment is an indication for the final measurement. The second moment is the final measurement, which takes place just before the completion of the building, if there is still enough time to repair leaks.



5.10 How is the blowerdoor test executed?

- The building is being over-pressurized
- The building is being under-pressurized
- Both of the above possibilities
- Neither of these options

5.11 Smoke test

Based on the blowerdoor test it can be clarified whether there are air leaks in the building. Where the air leaks are exactly can be discovered with a smoke test.

A smoke test is performed during the blower door test with smoke sticks or a smoke machine. Because air flows through

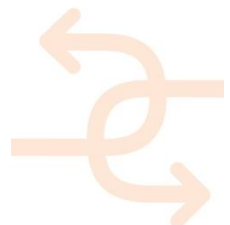

the cracks, this becomes visible in the smoke, which otherwise remains almost stationary. Smoking sticks are used around window frames. The smoke machine is used on large surfaces or with the possibility of larger leaks, for example, with large roof constructions or long linear leakages.



5.12 Ultrasonic scan

With the ultrasonic scan the air-tightness of the building envelope can be visualized with ultrasonic sound.

With an ultrasonic scan, a sound source is placed in or outside the building. It emits a high-frequency sound (ultrasonic). High-frequency sound can reach the other side of the structure even through very small openings because of its small wavelength. An ultrasonic receiver is used on the opposite site of the building. This measures the high-frequency sound waves that escape through the cracks and gaps of the building construction. The location and intensity of these leaks is made visible on the image plate below.

Because the building does not have to be completely wind and waterproof for an ultrasonic scan, air leaks can already be detected during the construction process, before a blowerdoor test is possible. These air leaks can be repaired more easily during construction than afterwards.

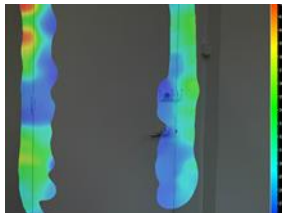

5.13 How many devices are needed for the ultrasonic scan to measure the sound density of a building?

- 1, an ultrasonic sound meter
- 5, an ultrasound generator, sound source, camera, ultrasound receiver and laptop with software
- 3, an ultrasonic sound source, a sound receiver and a sound meter

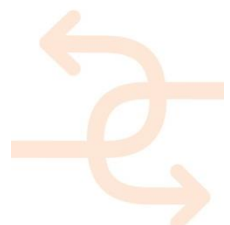
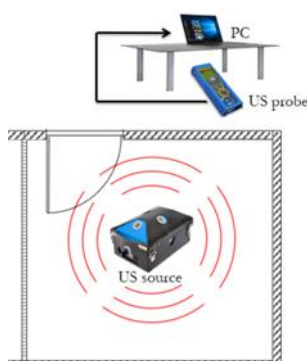

5.14 SoundBrush

The Soundbrush from LMS is a device that makes sound visible. The Soundbrush combines optical measurement with a sound intensity measurement and makes this visible in a 3D model. This creates a picture of the sound field and it is immediately visible where a noise nuisance comes from.

The SoundBrush is used to find sound leaks.

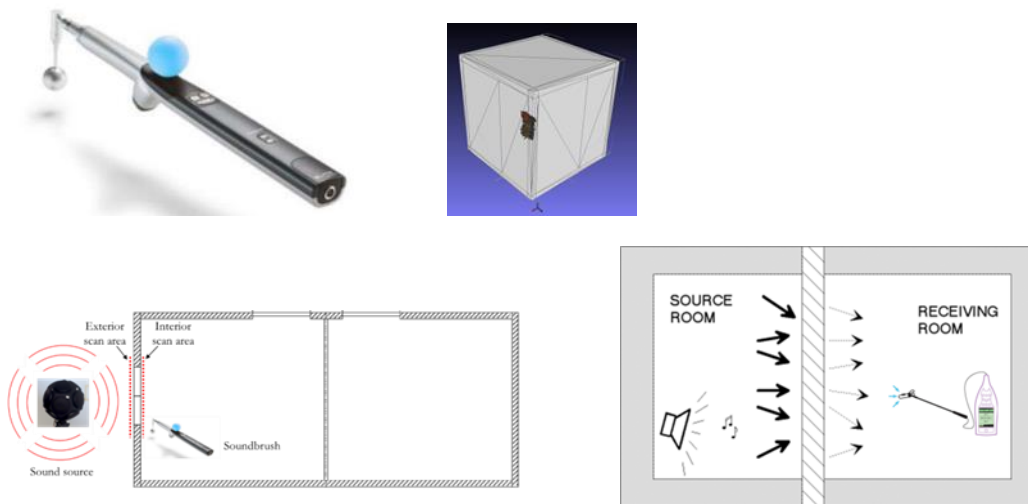

5.15 Fill in the blank spaces in the following sentence:

The LMS Soundbrush is a 3D, real-time test to measure and to

- find
- air leaks
- appearance
- visualize
- an object
- sound intensity

5.16 Microphone array

A microphone array (for example MEMS) is a composition of multiple microphones that are used to identify sound sources. The sound pressure level distribution is measured with the microphone array and is visualized.

Because the bundled microphones together form a large device, this technique is different from the SoundBrush. The

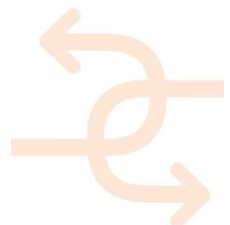

microphone array can only be used on a (part of a) smaller surface.



5.17 What is the disadvantage of the microphone array compared to the SoundBrush?

Multiple answers are correct:

- It is less portable than the SoundBrush.
- It can only be used on a larger surface.
- It is not suitable for use in construction.
- It can only be used on a smaller surface.

5.18 Thermography at the factory

During the construction of prefab panels in the factory, the structural integrity of the thermal quality of prefab elements can be tested using a thermographic camera and halogen lamps. Thanks to these tests, the prefab elements have already been tested well before they arrive at the construction site and any building faults are eliminated early on. With this test the U-value, (the measured value for the insulation value of how effectively a material is used as an isolator), of the wall can be tested on a prefab panel. This also makes it possible to determine whether thermal bridges are present. INSITER uses IR cameras with improved sensor methods for U-value assessment technology.

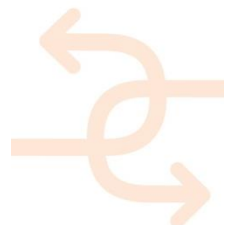
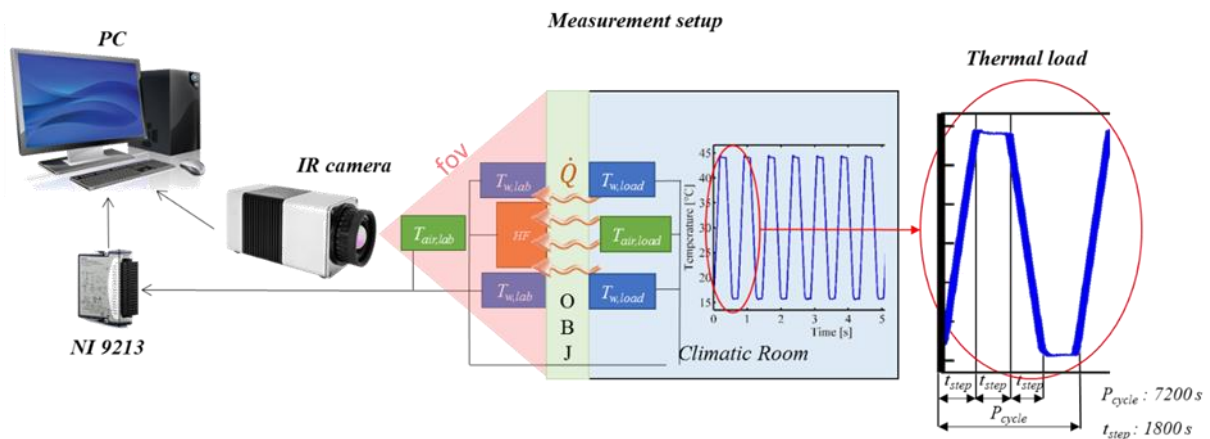

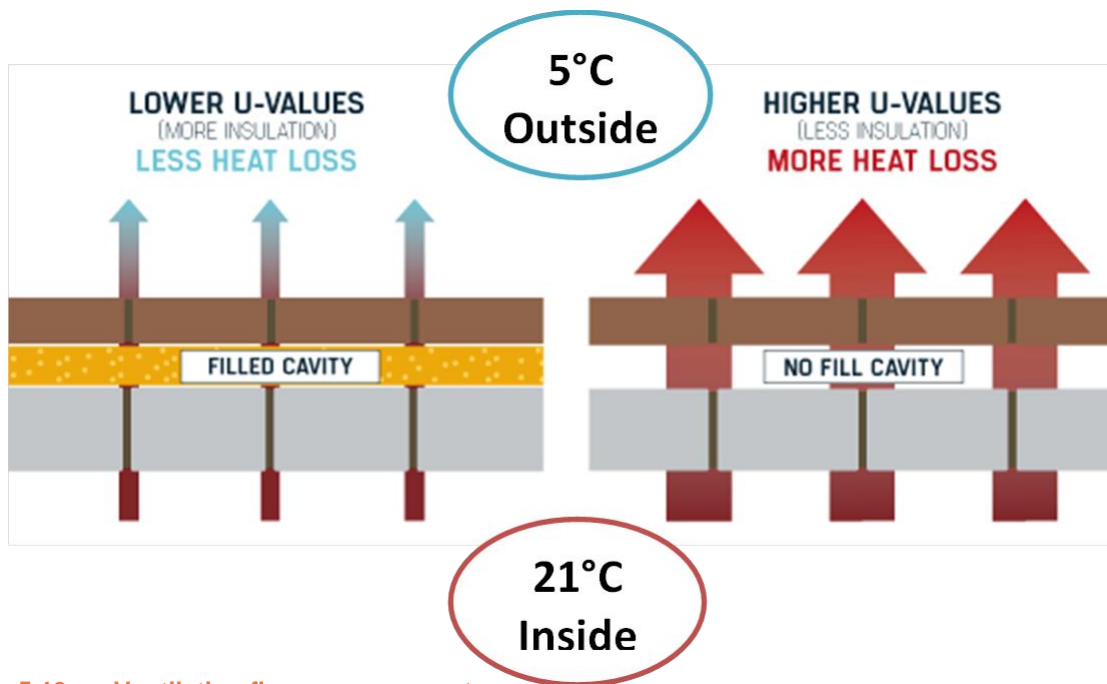

5.19 Ventilation flow measurements

The ventilation flow measurement in the room is done with a volume flow meter. The air flow rate per air diffuser is measured, to check whether the system is properly tuned.

An air flow meter consists of a funnel and a measuring instrument. It contains a built-in mechanism that ensures that the air flow volume does not change when the device is placed against the ventilation diffuser. For different size diffusers, different size funnels are available.

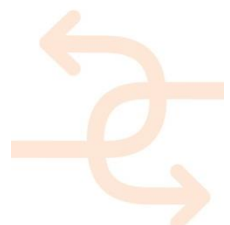



6. Changes through self-inspection

6.1 New actions through quality assurance

In quality assurance, different workers require to do extra actions, in addition to the work they already do. Because quality must be guaranteed, more inspections and registrations have to be carried out. These inspections can be carried out by an (external) inspector or the construction worker himself (self-inspection). INSITER is limiting the extra actions by using the 8-step methodology by using self-instruction (knowing what to do) and self-inspection (more responsibility for the worker).

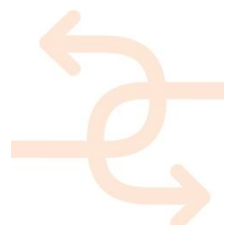

6.2 Role of the designer

This is the first step in quality assurance. The designers (architect and advisers) look at the program of demand, the legislation and regulations that are important and they identify the points of interest in a work or inspection plan. The points of attention follow from a risk analysis, the technical risks that can occur in the project are included in the work or inspection plan. This recognizes the risks and allows them to be actively monitored, which in turn, reduces the risk of errors. The plan is given to the site manager so that he / she knows what to look for and which subjects or intermediate steps have to be taken.

Finally, the designer makes a first set-up for the building dossier to be delivered. This is important input for organizing the (self) inspections to be carried out later.



6.3 What are the responsibilities of the designer?

- The building dossier
- Strategy determination
- Capture construction errors
- Risk analysis

6.4 Role of the work planner

The work planner is the intermediary between the designer and construction worker (carpenter, bricklayer, electrician, central heating engineer). He is responsible for checking and registering the work plan. Any newly identified risks must be presented and added to the work plan.

In addition to these tasks, the planner is also responsible for the design of the self-inspections. It specifies how the inspections should be carried out and which evidence should be stored.

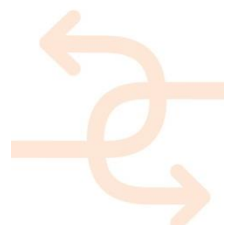

6.5 Fill in the blank spaces in the following sentence:

An important function of the work planner is ... the work plan. In addition, he is ... for the management of the building file.

- also a controller
- to check
- to carry out
- to make
- partly responsible
- fully responsible

6.6 Role construction and MEP worker

The construction workers are the last in line. They are responsible for recording and documenting the self-inspections that are included in the work plan and the building dossier. It is important that the knowledge level of the construction worker is sufficient. Identified problems must be documented and resolved. To do this well, regular coordination is needed with the parties involved on the construction site.

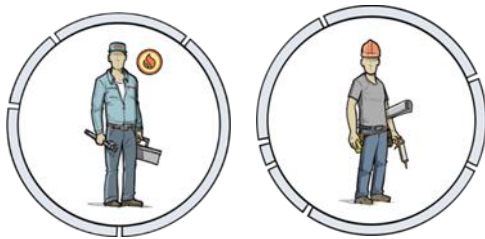

6.7 What are the most important tasks of the construction or MEP worker with self-inspection?

- Documenting identified problems
- Resolve detected problems
- Check the work plan
- Estimating the consequences of construction errors

6.8 Self-inspection competencies

The goal of self-inspection is quality improvement and to increase the level of construction workers through self-inspection. Through the checks on his own work, the construction worker learns from his own mistakes and he will become more and more unconsciously competent.

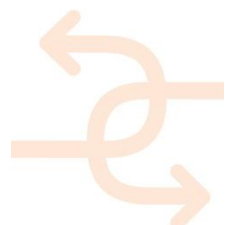

7. What does INSITER do?

7.1 Introduction

At the introduction and the steps self-instruction and self-inspection, the experience gained in the INSITER project has already been indicated. In this chapter what INSITER exactly does is described in more detail.

INSITER is an intuitive self-inspection technique using Augmented Reality. INSITER is used for construction, renovation and maintenance of energy-efficient buildings, made of prefab elements. INSITER contains a toolkit of easy-to-use techniques for self-inspection. Within the tool, Augmented Reality is used to support the process of self-instruction, but also the process of self-inspection. For example, by directly projecting inspection results on the BIM model.

The majority of energy-efficient buildings in Europe in 2050 will be realized by using industrially made and performance-oriented architectural and installation technology components. Achieving the performance requirements, however, is still too much hampered by errors during construction and renovation. For example, due to incorrect connections between the components, which are not detected or discovered too late. This ensures unnecessary energy loss during the life of the building.

Through intuitive self-inspection techniques, the gap between design and realization is closed and the full potential of the building will be utilized. INSITER uses BIM for standardized inspection and commissioning protocols, involving all stakeholders.

The INSITER tools provide insight into what happens at the construction site. The realized quality is documented and detected construction errors can be repaired in good time if necessary. In the future, these construction faults can be prevented by adding them to the system so that they can be used when assessing risks during design and preparation.

7.2 In the image below the marking on the road around a branch is made. Who is responsible for this error in this situation?



- The painter, for painting around the branch
- The client, for a tight planning
- Parks department, for leaving the branch
- It's hard to say afterwards

Feedback:

Afterwards, it is not possible to determine who is responsible for this error. Perhaps the parks department has not been on time with the clean-up. Perhaps the asphalt coaters did not have time to lay the asphalt, which meant that the painter had too little time. Perhaps it's the painter's mistake for not removing the branch.

Self-inspection is able to give insight into the cause of the problem in this situation.

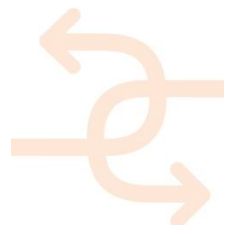

7.3 What is BIM?

A BIM (Building Information Model) is an important tool for creating, managing and sharing (digital) information in the life cycle of a structure.

Various definitions for a BIM can be found in the construction sector. Often the same is meant. The aim of a BIM is to promote cooperation between parties and to achieve a reduction in errors in the construction process.

With a good application of working with a BIM, each party has insight into the same project information from the data model. In a traditional process, on the other hand, this is only possible to a limited extent.

In addition to the data model, there are also agreements about quality, organization, communication and information provision in the construction process. Different parties are faced with a BIM. These are architects, (installation) consultants, constructors, installers, contractors, manufacturers and maintenance companies.

Recent research has shown that BIM and VR/AR/MR -based training on the construction site provide a reduction of 90% on incidents, 10% on delays and 5% on failure costs. (Source Makemedia)

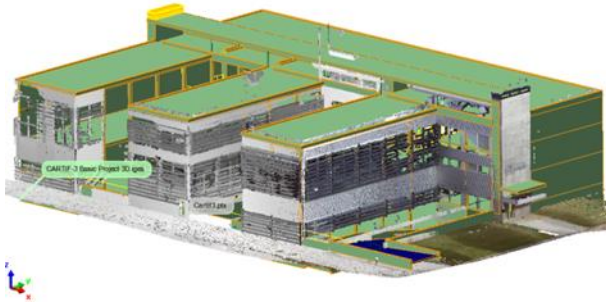

7.4 Choose the correct answers to fill in the blank: What are the three main functionalities of a BIM?

To ... building information.

- reduce
- calculate
- model
- check
- share
- manage

7.5 INSITER BIM & AR

Within INSITER, various studies have been carried out to integrate inspection techniques in the construction process.

These 'innovations' are showed in the following video.

<https://www.youtube.com/watch?v=yZ78OGInIMc&feature=youtu.be>

7.6 QR code

A QR code is a two-dimensional bar code. The QR codes can be used for identifying products on construction, for

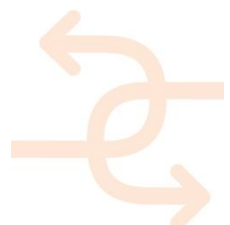

example on façade panels. The façade panels are delivered at the construction site and the QR codes on the panels are scanned to compare the specification of the delivered panel with the specification from the design.

The QR codes contribute to self-inspection and self-instruction. When scanning a product, the available inspections or instructions will be displayed with the required information. The position of the product in the BIM model can also be visualized. The scan therefore serves to win information about a product and to verify that the right product is positioned correctly.

7.7 Structure of INSITER

INSITER is a self-acting tool on a smart device (tablet, smartphone or smart glasses), where important data is stationed on a remote server. All measurements, self-instructions and self-inspections are stored on this server. The server can be consulted at any time, for example at the construction site with AR (augmented reality) or to inspect the inspections and the BIM.

7.8 Self-inspection with INSITER

The image below shows the improvement process of INSITER. During the construction process, architectural and building physics will first be checked, followed by installation engineering (HVAC/MEP). During the final phase, it is measured whether the building functions as designed.

When using the INSITER tools, every employee is responsible for checking his own work. It is important that the knowledge level is up to date and that the employee can work with the INSITER tools. The INSITER tools supports the work by offering inspection protocols for self-inspection purposes and by providing various user instructions.

All the recorded material is collected in the building dossier and serves as proof of correct work and to learn from for future projects.

7.9 Inspection protocols

An inspection protocol is a predefined guideline for performing self-inspections. Basic elements of protocols are:

1. It is a fixed method;
2. It may be mandatory;
3. Used to implement standards;
4. Obligation to stay within a certain framework.

7.10 Mobile inspection applications

Devices used to perform self-inspections are:

- Mobile phone
- Tablet
- Smart glasses (AR), for example, Microsoft HoloLens

INSITER has developed prototypes for software.

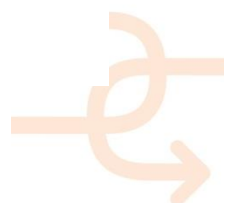

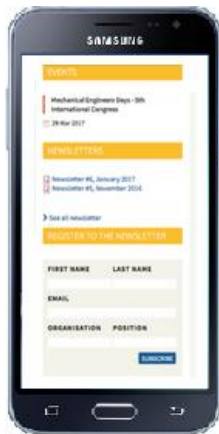

7.11 INSITER inspection application

The INSITER application supports the construction worker on various levels. It offers self-inspection and self-instruction possibilities, possibilities for AR and serves as a building dossier.

In the application, the construction worker gets an overview with options, for example to get information about a certain product or how to install/inspect that product. With the help of Augmented Reality, the exact location of an object can be determined or the project planning can be retrieved.

7.12 Other inspection applications

An inspection app is a way to register and share shortcomings during construction quickly and easily. The advantage of most apps is that the observed error can immediately be located and digitally registered. Subsequently, the status of the error can be tracked, for example if a follow-up action is required.

Communication about building errors was not always easy. The textual description often caused miscommunication. For example, the remark "Review radiator in bedroom": Which radiator, which bedroom, review is that just 'viewing' or is an action required?

With an app you can quickly and easily indicate very precisely where a problem is located in the map and with a photo you can quickly make clear what problem is involved. In the photo you can add extra information such as an arrow or a circle to clarify issues. This way you can be sure that the right problem will be solved.

Inspections are therefore faster and there is less confusion of speech. The app itself does not mean that the inspection is going well. For that, a protocol is required. A protocol indicates what is checked, when it is checked and so on.

INSITER has developed prototypes for software

Some other known inspection apps are:

- Edcontrols
- Snagr
- Snagstream
- Keurix
- 7lab inspection and inspection app

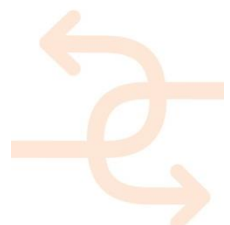

- Moreapp
- Apee
- Alphaplan

7.13 Data integration in INSITER

3D laser scans, thermographic photographs and acoustic data can be integrated into the BIM model. The collected data can be added to the BIM model by using a positioning system. This means that a thermographic photograph can in practice be viewed directly on the spot with, for example, augmented reality glasses. Where both the current situation and the BIM model can be seen with the thermographic recordings.

7.14 Consequences BIM



All the recorded material from the inspections will be collected in the SharePoint database, based on GUID reference codes from the BIM. This material can be consulted in practice and serves as a building dossier for after the completion of the project. During the construction process, the BIM is continuously mirrored and decisions about deviations are made immediately, based on the inspections that have been carried out.

The BIM is therefore no longer a tool for the design phase, but is also used during construction. Also, it serves as the basic structure for a building dossier, where information about and during the construction process is stored and managed.

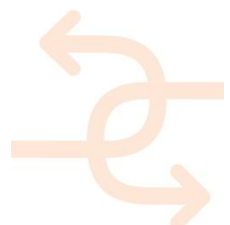

8. Training 8-step INSITER methodology

8.1 Introduction 8-step INSITER methodology

Within INSITER, a new "8-step" methodology for new construction and refurbishment of energy-efficient buildings made of prefabricated components has been developed. The elaboration 8-step method indicates who does the self-inspection.

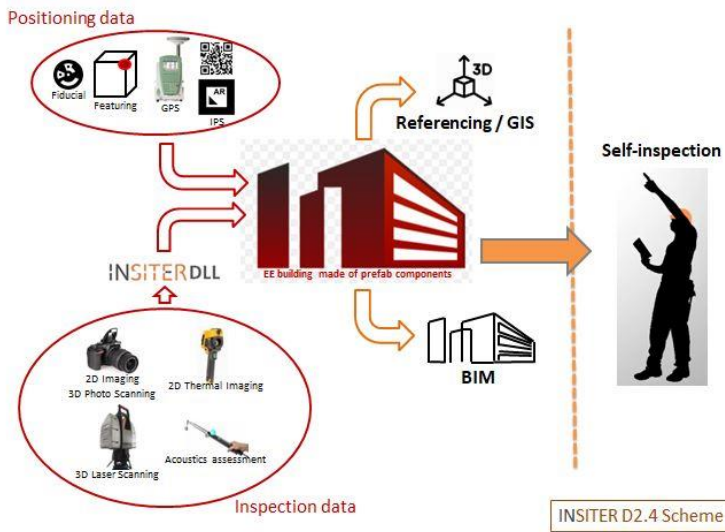

Figure 30: Positioning and inspection data

An app has been developed in the INSITER project. The image shown is an example of the project Hoge Kamp, Enschede:

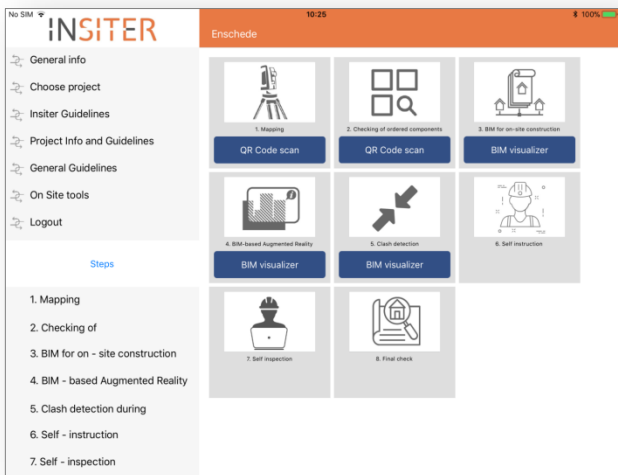
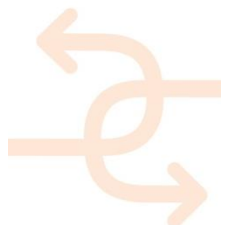

Figure 31: 8-step INSITER methodology shown in app

In the first part of the training, the 8-step INSITER methodology will be explained generally. In the second part of the training, a practical case will be discussed. The training ends with a summary of the benefits of the 8-step INSITER



methodology.

8.2 Step 1: Mapping

Step 1 is mapping the actual conditions of the construction site. For example identify the correct working area (floor/room/space) before starting with installations and capture the actual on site conditions.

For refurbishment / renovation, in this step consideration is given to:

- Which structural components can be maintained?
- What is the status or quality of the outer façade?
- Which installations can be maintained and which can be disassembled and removed?
- What measurements are needed for the new design?
- In what time can we realize the project according to what budget?

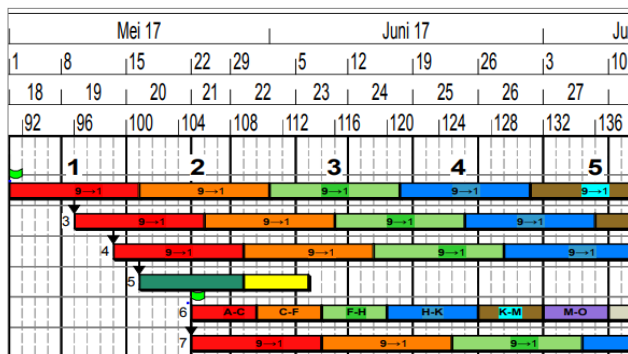

Figure 32: Planning

For new construction, the work area and surroundings are inspected, e.g. what buildings are already there or will be next to the new building. This step is carried out by the residents, owners and technical advisers/inspectors.

During this step, elaborated measuring methods from INSITER are used:

- Thermographic examination of existing facade to be maintained;
- 3D laser scanning.



Figure 33: 3D laser scanning

These measurements are carried out by the architect, contractor or subcontractor.

Parts of step 1 can also be executed by a construction worker after the building and the installations have been completely designed.

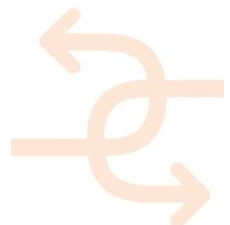

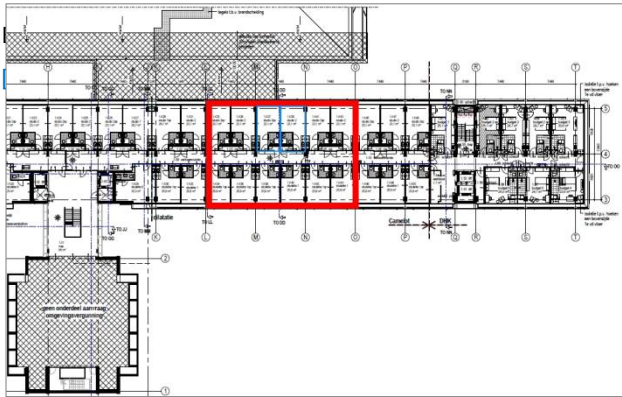

Figure 34: mapping of a specific area

Explanation: The construction worker opens the INSITER app on his smartphone or tablet and reads the instructions. The mechanic sees which HVAC/MEP components must be removed in order to be able to install and connect new installation systems.

8.3 Step 2: Self-inspection during purchasing, production and delivery and checking of prefabricated ordered components.

In step 2 of the INSITER methodology, a product and quality check takes place after delivery of products at the construction site.

Prefab elements are equipped with a QR or RFID code. The construction worker scans the code with his smartphone. The correctness of the delivered components is checked, transport related damages are recorded and the storage requirements are shown. The delivered component is identified and will be linked to that specific element in the BIM model. The location of the prefabricated element corresponds to the location in the BIM model.

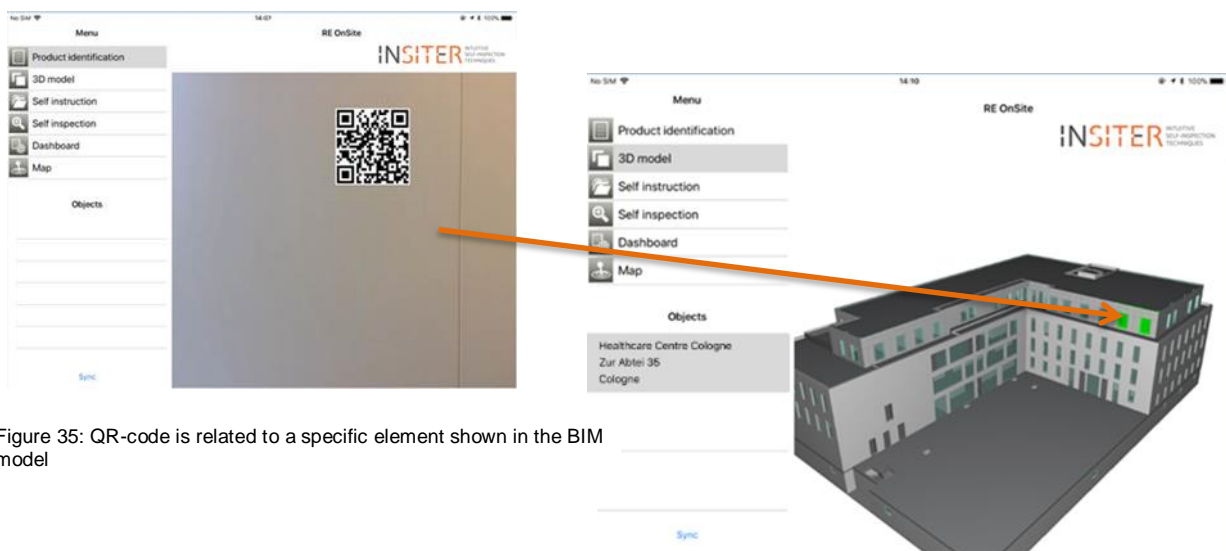
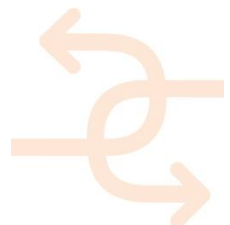

Figure 35: QR-code is related to a specific element shown in the BIM model



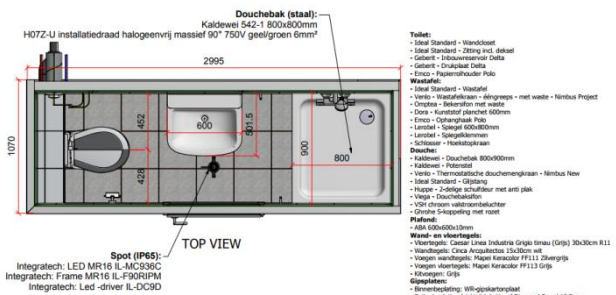

Figure 36: Example of prefab bathroom

8.4 Step 3: BIM for on-site construction

When a BIM model of the building does not yet exist, the (existing) building will be modelled in BIM for on-site construction. With refurbishment, it involves the models of the existing building and the new and to be maintained MEP/HVAC components.

This work is carried out by the architectural and installation technical BIM modellers.

In this step the designers evaluate the design:

- parts of the building with the greatest possibility for errors;
- parts of the building with a great influence on the energy performance and quality of the building.



Figure 37: Comparisons between real live situation and the BIM model: general outside and inside views on the façade panels



Figure 38: Comparisons between real live situation and the BIM model: corners in a corner room and middle room

At INSITER the following 9 critical components are investigated:

- Architectural critical components:
 - Foundation and ground floor;
 - Exterior facades and elements to be built in, such as glazing;
 - Glass facades;



- Roof.
- Connections between new construction and existing building

- MEP/HVAC critical components:
 - Heat pump;
 - Ventilation installation;
 - Solar water heater installation;
 - LED-lighting.

In the BIM model at INSITER, extra attention is paid to the critical components.

During construction, step 3 can be accomplished as follows:

Using his mobile device, the construction worker opens the BIM model of the specific part of the building where he has to remove the existing HVAC components and install the new ones. In this BIM model, he can observe how the HVAC components are modelled and integrated within the building.

8.5 Step 4: Create and deploy BIM-based AR (Augmented Reality) in a project for self-instruction and self-inspection

In the INSITER project the BIM 3D model is used in combination with Augmented Reality (deployed by MS HoloLens glasses). In the current state of technology, the BIM model is far too large (a huge amount of data) to be used directly for AR. So within INSITER, the BIM model has been simplified, in such way that it can be used with AR. In INSITER the BIM-based AR solutions are used to visualize BIM, process sequences, technical details or measurement data.

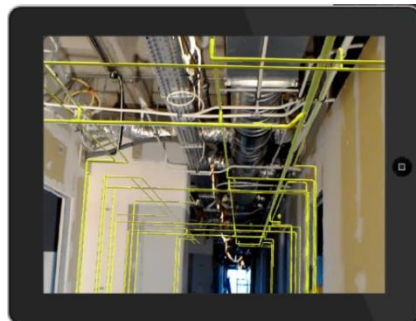
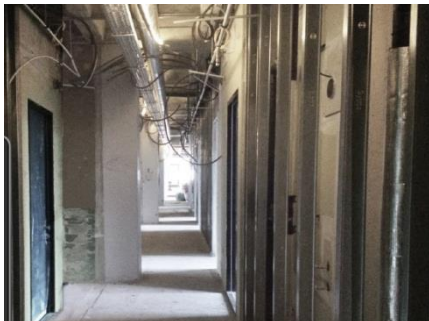

Figure 39: AR visualisation of MEP installations

In step 4, AR is used as follows:

The technician uses his mobile device (smartphone, tablet or HoloLens) and opens the BIM model in the workspace on the project. The mobile device is equipped with the AR application. On the actual position in the building, the technician sees which installation parts have to be mounted where.

Step 4 works together with step 5, clash detection during execution.

8.6 Step 5: Test AR on-site for visual comparison between BIM model and realisation based on visualisation of virtual clashes / inconsistencies.

In the INSITER project the BIM 3D model is also used in combination with Augmented Reality (MS HoloLens glasses) to perform clash detection during construction. In the design of the building and the installations extensive clash detection takes place between the various design disciplines. The clashes between installations, constructions and other structural

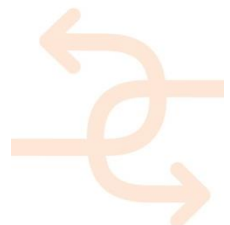

components contribute to an integral design.

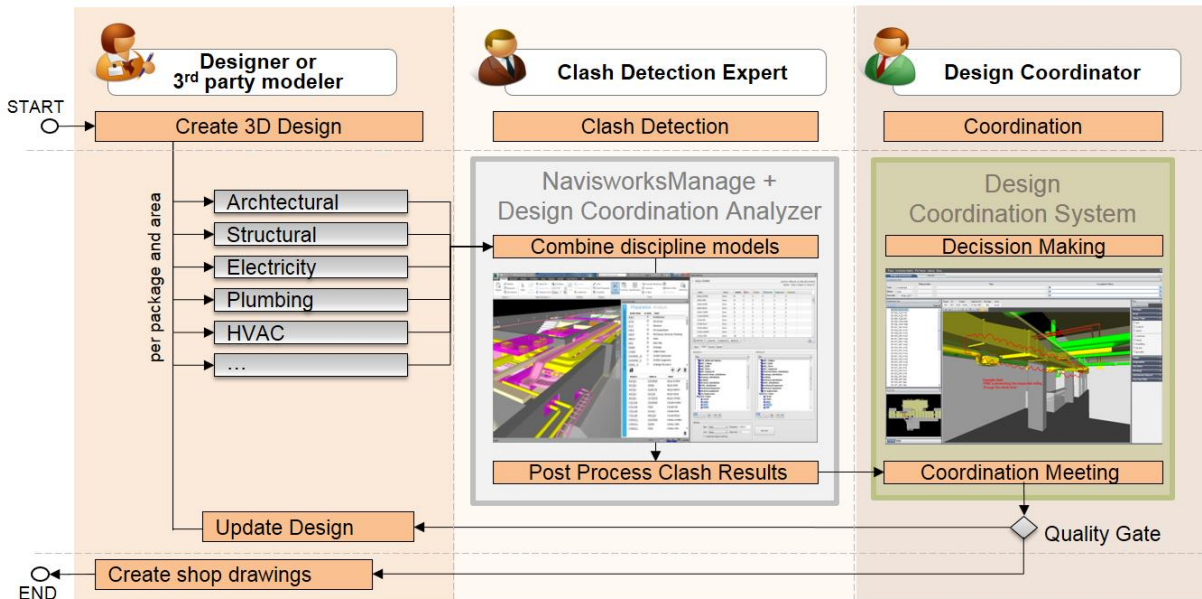

Figure 40: General process of performing clash detection

Clash detection is done off-site in the design. One-site the clash detection is used to control the situation.

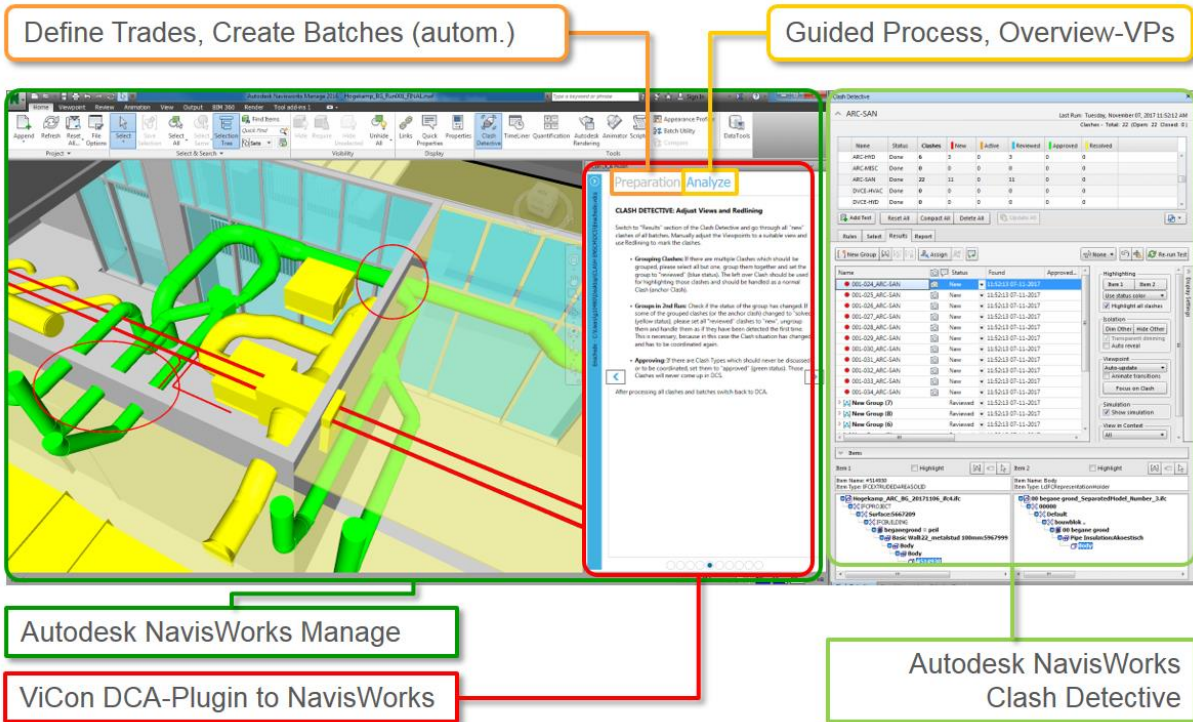
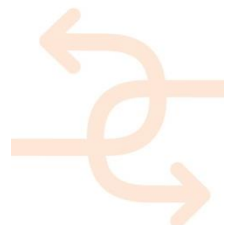

Figure 41: BIM-based MEP model



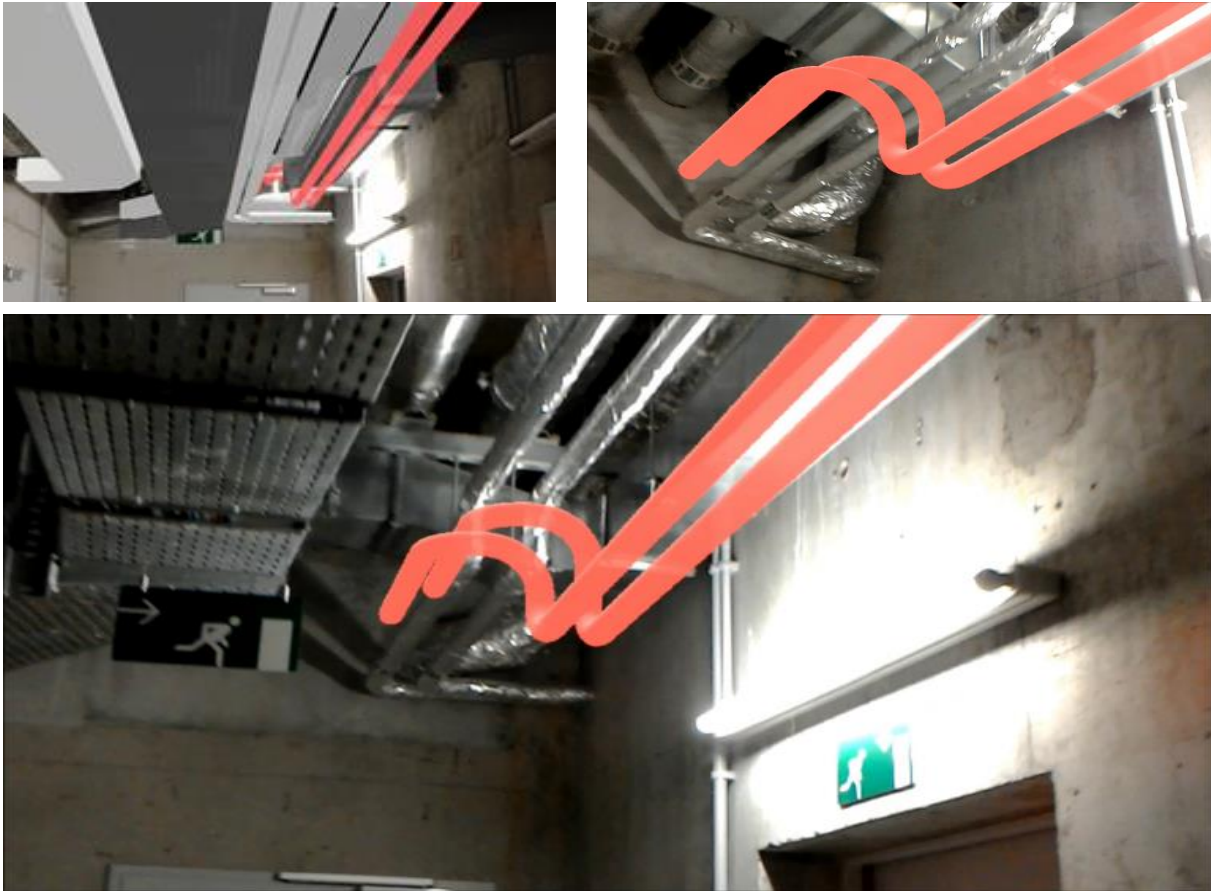

Figure 42: Visual comparison example between BIM-based MEP model and the planned to-be target state and installation of the MEP system to be conducted with MS HoloLens

D2.2 Robust and practical solutions of Augmented Reality for construction sites	<p>INSITER Solutions</p> <p>INSITER BIM AR Vision:</p> <p>Complex BIM Models, Planning and Instrumentation Data</p>	<p>Visualized Planning Data</p> <p>AR Solution for extensive and complex IFC BIM models for on-site self-inspection with referenced planning, self-instruction documentation and instrumentation data (with tablet computers)</p>	<p>Screenshots</p>
	<p>INSITER HoloLens BIM-based Mixed Reality:</p> <p>Detailed BIM-based 3D scenes, including e.g. MEP systems etc.</p>	<p>Detailed 3D scenes and BIM model evaluation for on-site self-inspection or self-instruction (with MS HoloLens)</p>	
	<p>INSITER BIM-based Self-Instruction AR:</p> <p>Detailed BIM-based Process Guidance and Simulation</p>	<p>Detailed self-instruction simulation and visualization (with tablet computers, smart glasses or MS HoloLens)</p>	

Figure 43: AR Solutions used in INSITER



Not all clashes will be solved during the design phase. There will always be a number of clashes, provided with additional information or instructions, which must be solved in the work. Within INSITER a so called IFC Clash Cube Model Generator has been developed, which puts a block around the clash in the BIM model. These clashes are recorded in the BIM model.

In step 5, AR is used as follows:

The technician uses his mobile device (smartphone, tablet or HoloLens) and opens the BIM model in the workspace on the project. The mechanic sees the clashes through the clash cubes (cubes). The technician follows the instructions and will solve the clash during assembly. The mechanic also sees whether the HVAC / MEP installations really fit into the architectural design and there is no clash with electrical installations or constructions. In addition, there is the possibility that, due to a final change, not all contractors have updated the BIM model. The mechanic can see a (larger) clash at this stage of the work and provide feedback directly to the construction manager for a solution.

8.7 Step 6: Self-instruction during the preparation and logistics of the construction site and during construction.

The aim of step 6 is that by self-instruction with BIM based model by use of a mobile device the quality of the work for building and MEP systems are improved. The worker proceeds with the assembly activities using supporting material and given hints.

An app has been developed within INSITER, which contains the guidelines and instructions for assembly. During the preparation of the project, the app is filled by the work planner, the assembly manager and the site manager with the correct guidelines and instructions for assembly.

Step 6 is used on the construction site as follows:

The technician uses his mobile device (smartphone, tablet or HoloLens) and opens the project with the work, e.g. the installation of the installations. The technician goes through the guidelines and instructions step by step. The step-by-step instructions are provided with many tips and instructions to prevent common mounting errors.

Supervision and support is provided where necessary.

8.8 Step 7: Self-inspection during construction, refurbishment and maintenance

In step 7, inspection and validation of the results takes place through self-inspection during the construction or refurbishment process. The worker checks his own work by using checklists. He performs measurements with special equipment if needed to check the as-is installations.

After the MEP or HVAC systems have been installed by the MEP/ HVAC workers or the façade parts are installed by a construction worker, the MEP/construction worker checks his work himself by specially developed checklists (inspection protocols). The checklists are filled in via the app and centrally stored for the building file. Photos are also taken to be stored in the building dossier. Detected deviations are directly discussed with the site supervisor.

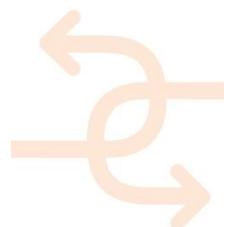

Category Intervention	Refurbishment
Critical EeB Component	Mechanical ventilation
INSITER Methodology	<input type="checkbox"/> Step 1: Mapping
	<input type="checkbox"/> Step 2: Checking of ordered components
	<input type="checkbox"/> Step 3: BIM for on-site construction
	<input type="checkbox"/> Step 4: BIM-based Augmented Reality
	<input type="checkbox"/> Step 5: Visual clash detection during construction
	<input type="checkbox"/> Step 6: Self-instruction
	<input checked="" type="checkbox"/> Step 7: Self-inspection
	<input type="checkbox"/> Step 8: Final check
Intervention description	<p>Main critical points:</p> <ul style="list-style-type: none"> • Air leakage due to ventilation (tightness of the duct system) <p>Key activities:</p> <ul style="list-style-type: none"> • Fill-in the checklist; • Take at least one picture for each question of the checklist; • Add notes when needed and report your findings.
Technical data and information	<ul style="list-style-type: none"> • Example_Common errors • Example_Self-inspection activities

Table 1: Guideline for self-inspection mechanical ventilation

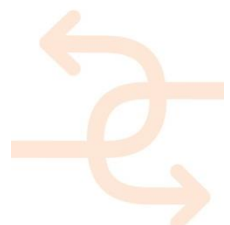

Screenshots:

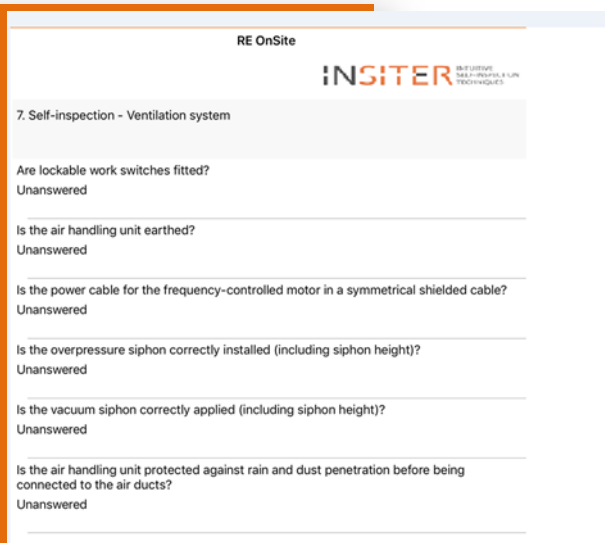

8.9 Step 8: Final check

At step 8, the craftsmen or construction worker indicates via the app that the work is ready. He makes a summary and reports on the finished work, including photos taken on site, noted errors and doubts. The site supervisor checks the report. He approves the work or indicates that work needs to be adjusted or redone. The approved work is stored in the building dossier.



Figure 44: final check of the MEP-installation



9. Example of practical use of INSITER Guidelines according to the 8-step methodology

STEP 0 - Log-in & work schedule

The construction worker logs-in to the mobile application and receives a schedule and an overview of the activities that he has to do during the day. If he has to do a task that he has never performed before and he wants to get introduction in advance on a format of a video or other supporting document, he can find available material through links. Following the scope of the guidelines, he focuses on critical EeB (energy-efficient building) components. He selects the critical EeB component that he has to work with according to his daily tasks and he starts the “guiding tour” through the INSITER 8-Steps based application.



STEP 1 - Mapping

The construction worker in this step needs to capture the conditions and to compare them with the as-is situation. He begins his work by defining/mapping the location/room/space within the building where he needs to work for the installation/refurbishment of the critical EeB component. He goes to the location and he makes a preliminary evaluation of the actual conditions on site. He can retrieve reference material for main energy-efficient and quality construction errors to be checked.

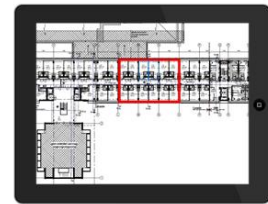

Note: In case he detects criticalities, in the scenario of refurbishment, and it is needed to take measurements with special equipment, he notifies the construction manager and specialized personnel arrives and performs the required measurements

STEP 2 - Checking of ordered components

The critical EeB components to be installed are delivered on the building site. Using QR or RFID scanning tool, the construction worker checks whether these are the correct components as specified in the BIM model and the technical documents. In this step, he can check the correctness of the delivered components on site before assemble them, or/and retrieve the components ID and visualize the positioning of it.

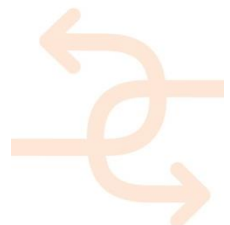

STEP 3 - BIM for on-site construction

This step includes visualization of the building or the critical EeB components in BIM. Using the mobile device, the construction worker opens the BIM model of the specific part of the building where he has to perform his work with the critical EeB component. In this BIM model, he can observe how the critical EeB components are modelled and integrated within the building and use it as a reference for his actual work on site.

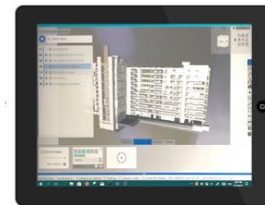

STEP 4 - BIM-based Augmented Reality

Using the mobile device (smartphone, tablet or HoloLens) equipped with an AR application, the construction worker projects the BIM model of the new HVAC components to be installed onto the real spatial environment. This step can work complementary with Step 5.



STEP 5 - Clash detection during construction

During this step, the worker on site can project the designed situation (correct situation) of the critical EeB components on real situation within the building, while focusing on the criticalities (clashes). He facilitates AR to check if the critical EeB component to be assembled really fit within the intended building part/space/room, i.e. no "clashes" with building components.



STEP 6 - Self-instruction

The construction worker opens the manual documents/videos/animations where the mounting of the critical EeB components is described in a step-by-step process with easy guidance and hints/warnings of common errors to be avoided. As an INSITER tool for this step has been developed the mobile application, where the mounting process-critical assembly activities can be simulated and supporting reference material can be given.



STEP 7 - Self-inspection

During this step, the worker on-site will check his own work with the help of checklists. Subsequently, if needed, he notifies a specialist to measure the exact performance using specialised equipment (ref. to WP2). The measurement image (thermal, acoustic etc.) can be either superimposed to BIM or AR for visual evaluation, or kept for integration into the BIM model later on of-site for the definition of the as-is situation and the equivalent calculation of the actual

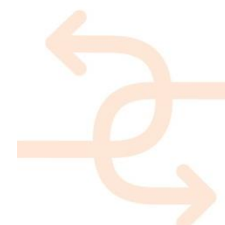

performance of the building according to how components were assembled in reality.

Note: In case it is needed, the measurements with special equipment will be performed by a specialist, after the construction worker notifying him. The evaluation of the result will be done off-site as time is required for the retrieval of the measurement results.

STEP 8 - Final check

After collecting data from all the previous steps, the final step consists of the final evaluation of the work to be delivered. The construction worker completes his assignment by reporting on the finished work, including some photos taken on-site. He should also note errors or doubts, if any, into his digital report through the mobile application. The site supervisor opens this report, and gives approval or asks for rework. The approved works appear on a common INSITER dashboard (off-site) showing the level of quality and performance during the on-site process.

Quality, time and cost evaluation can be monitored like that by the construction managers. The INSITER dashboard continually receives info.

The dashboard works with the traffic light system:

Red: Not OK/ rework

Orange: Doubt decision by

Green: OK

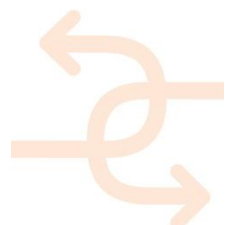

10. Summary

The new "8-step self-inspection" method in construction and renovation includes the following steps:

The INSITER Process



1. Mapping; creating geometric and semantic inventories of an existing building in a refurbishment scenario
2. Checking; ensuring building components comply to specification and are undamaged delivered on-site
3. On-site BIM; modelling and preparing BIM-models for on-site usage
4. BIM-based AR; Augmented Reality as on-site guidance for the construction worker based on BIM
5. Clash detection; determining the implications that on-site deviations have on the construction process
6. Self-instruction; providing user-friendly self-instruction material to the construction worker
7. Self-inspection; inspecting one's own and each other's work on-site and identifying deviations
8. Final checks; keeping track real-time of the construction process through condensed information

