

# Case study elaboration, field validation protocols, and equipment calibration

Deliverable report D5.3



Deliverable Report D5.3

Issue date on 28 February 2017

# Case study elaboration, field validation protocols, and equipment calibration

Deliverable report D5.3

Issue Date	28 February 2017
Produced by	Work Package 5 Team (Task leader 3L)
Main author	Klaus Luig, Dieter Jansen (3L)
Co-authors	Rizal Sebastian (DMO) Benedetta Marradi (AICE) Emanuele Piaia, Luigi Vessella (IAA) Maria Haensch, Ruud Geerligs (SBR) Günther Riexinger (FHGIPA) Carlos Bárcena (DRA) Jan-Derrick Braun (HVC) Pedro Martin Leronés (CARTIF)
Version:	Final
Reviewed by	Sanja Durmisevic (DMO) and Emanuele Piaia (IAA)
Approved by	Ton Damen – Project Coordinator (DMO) Rizal Sebastian – Technical Coordinator (DMO)
Dissemination	Public

## Colophon

Copyright © 2017 by INSITER consortium

Use of any knowledge, information or data contained in this document shall be at the user's sole risk. Neither the INSITER Consortium nor any of its members, their officers, employees or agents accept shall be liable or responsible, in negligence or otherwise, for any loss, damage or expense whatever sustained by any person as a result of the use, in any manner or form, of any knowledge, information or data contained in this document, or due to any inaccuracy, omission or error therein contained. If you notice information in this publication that you believe should be corrected or updated, please contact us. We shall try to remedy the problem.

The authors intended not to use any copyrighted material for the publication or, if not possible, to indicate the copyright of the respective object. The copyright for any material created by the authors is reserved. Any duplication or use of objects such as diagrams, sounds or texts in other electronic or printed publications is not permitted without the author's agreement.

This research project has received funding from the European union's H2020 Framework Programme for research and innovation under Grant agreement no 636063.



## Executive summary

The most important result of this deliverable is the description and preparation of onsite tests that will be performed at 6 demonstrators in Europe. These demonstration projects are related to new construction, retrofitting, maintenance as well as additionally on the finishing prefab-process at factory level as the interface between finishing prefab activities at factory level and site delivery has been identified as a relevant quality assurance problem.

The 6 defined demonstration projects are related to new construction, retrofitting, maintenance and additionally on the finishing prefab-process at factory level as the interface between finishing prefab activities at factory level and site delivery has been identified as a relevant quality assurance problem.



**Demonstrator 1: Health Centre Cologne, D, responsible partner 3L.** The Cologne demonstrator is a roof top extension with prefab light-weight elements on an existing building erected in 2012. This project is defined as a hybrid, because an additional new part of a building will be connected structurally with an existing building without retrofitting it. Field demonstration activities will focus on scanning the QR code, geometric check of the ground sill and application of AR.



**Demonstrator 2: Cartif-3, E, responsible partner Cartif.** Cartif-3 is an existing prefab nearly zero energy research building. It contains large facilities for real scale chemical/industrial prototypes testing and offices. Field demonstration activities will focus on checking of measured values of building components, measurement thermal performance and commissioning of solar thermal systems related to maintenance demands.

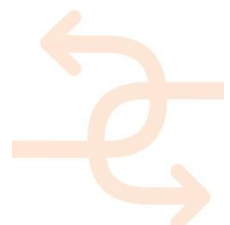



**Demonstrator 3: Concetto Marchesi, I, responsible partner AICE.** The Concetto Marchesi, located in the eastern part of Pisa, is a modular school building from 1974 with a modular construction grid, a precast structure and made of prefabricated components. The building is in poor maintenance condition and therefore deep renovation processes will be performed. Field demonstration activities will focus on geometrical consistency, testing of thermal bridges and checking of the connections between existing building and additions.



**Demonstrator 4: Hogekamp, NL, responsible partner DEMO**  
This demonstrator is the deep retrofit, redesign and transformation of an abandoned university building, originally erected in 1965, into a student hostel and hotel building. The field demonstration activities will focus on the testing and inspection of new facade panels, parts of a new MEP system and a mobile inspection tool for post-renovation condition assessment.



**Demonstrator 5: The Green Village, NL, responsible partner SBR.** Demonstrator 5 will be erected on the campus of the University of Delft. The new prefabricated office building is based on wooden modules. The field demonstration activities will focus on the positioning of the building elements with the help of QR codes, the testing and inspection of air tightness measurement on site and digital VR instruction including dimensions and tolerances facilitating assembly on site.

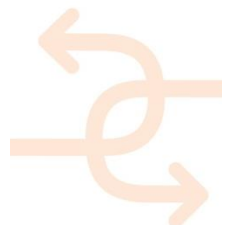



**Demonstrator 6: Dragados Factory, E, responsible partner Dragados.**

Demonstrator 6 is containing industrial buildings and workshops where panel and modules are prefabricated, pre-assembled and pre-commissioned since 1974. The most critical processes at factory level affecting the final quality of the final building are the roof and facade panel fabrication and preassembly, the testing of the joints, the installation of the MEP/HVAC components on the modules and the pre-assembly of the modules. The quality/energy performance will be checked, too.

Demonstrator	New construction	Retrofitting	Maintenance
Health Centre Cologne	X	(X)	
CARTIF-3			X
Concetto Marchesi		X	
Hogekamp		X	
The Green Village	X		
Dragados Factory	X	(X)	(X)

Table 1: list of demo cases and testing field assignment

The Health Centre Cologne is representing a hybrid demonstrator as it is a new construction project and sort of a retrofitting project at the same time. Typical retrofitting projects are Concetto Marchesi and Hogekamp. The Green Village is a new construction while CARTF-3 is focusing on maintenance issues. The Dragados Factory is giving impact on all testing fields, representing panels that might be used for new construction and retrofitting at the same time and additionally promoting an easy-to-handle maintenance already foreseen at design and prefab stage.

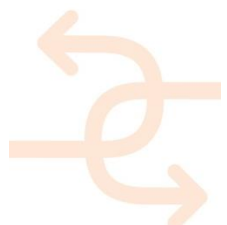

Within each of the 6 demonstrators three critical construction topics have been identified. The INSITER toolset should be tested and validated regarding the issues that are defined in this deliverable. To prepare the INSITER toolset for the aimed use cases it is essential to describe the proposed processes in detail. Therefore, storyboards for each demonstrator have been created and concrete demo cases have been identified. The storyboards involve all stakeholders and their characteristic demands in order to assure the interaction related to quality issues. The objective of the storyboards is to follow and describe the regular workflow on site and demonstrate the intervention for quality assuring by the INSITER methodology and toolset at different phases of the project. The storyboards are describing actions related to the INSITER toolset in the given construction situations. This will enable the INSITER project to adjust the required software functionalities and to prepare the BIM models as well as the IT environment in a most suitable way. The demo cases are defined and used as samples in order to validate the INSITER tools and methodologies. Related to the quality assuring self-inspection and self-instruction methodology supported by the INSITER tool the testing needs and processes on sites are prepared and pre-defined. The validation will be done on site and is prepared in D5.3. It will be further elaborated in *D5.4 Field validation report and recommendations*. The tests on site will be described in detail in *D5.5 Field demonstration set-up*, the results of the site testing will be reported in *D5.6 Field demonstration report* and finally analysed in *D5.7 Cross-case analysis and benchmarking*.

The holistic data collection of all demonstrators including the inventory lists is available at the INSITER project SharePoint website.

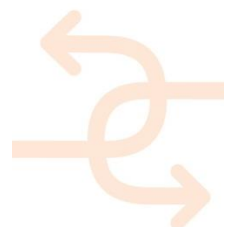

## List of acronyms and abbreviations

- AEC: Architecture, Engineering and Construction industry
- AR: Augmented Reality
- BIM: Building Information Modelling
- BLC: Building Life Cycle
- CAD: Computer Aided Design
- DoA: Description of the Action
- EE: Energy Efficiency
- EeB: Energy Efficient Buildings
- GUI: Graphical User Interface
- GUID: Globally Unique Identifier
- HFM: Heat Flow Method
- HTML: Hypertext Markup Language
- HVAC: Heating, Ventilation, Air Conditioning
- ICT: Information and Communications Technology
- IFC: Industrial Foundation Classes
- ISO: International Organisation for Standardization
- KPI: Key Performance Indicator
- LCA: Life Cycle Assessment
- LCC: Life Cycle Cost
- M&E: Mechanical and Electrical services
- MEP: Mechanical, Electrical, Plumbing
- MTT: Methods, Tools and Techniques
- NDT: Non-destructive test
- nZEB: Nearly Zero Energy Building
- QC: Quality Control
- QR code: Quick Response Code
- TCO: Total Cost of Ownership
- URL: Uniform Resource Locator
- VR: Virtual Reality
- WBS: Work Breakdown Structure
- ZEB: Zero-Energy Building

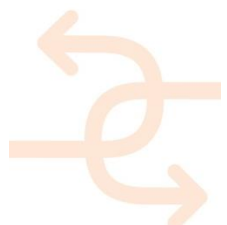

## Definitions

- **Project:** INSITER demonstration deals with six real projects. The demonstration validation testing and training activities take place on these real building sites.
- **Self-inspection:** encourages, enables and equips construction workers to check their own working processes and the results respectively, both individually as well as peer-to-peer with other workers.
- **Self-instruction:** is a pro-active approach to provide craftsmen and professionals with interactive guidance during their working processes. Self-instruction is facilitated on the workers' mobile devices, with continuous updates based on both pre-planned (designed) process as well as real-time feedback from self-inspection. Self-instruction prevents wrong actions, and helps the workers to rectify any error immediately.
- **Storyboard:** A storyboard is a description of a follow up of steps in the real workflow related to a single building site. The storyboard approach identifies important project steps and interaction. The objective is to create demo cases that are important related to characteristics for the application of the INSITER tool at building sites at the most effective and efficient level. Storyboards are representing a characteristic and important selection of building sites workflow.
- **Demo case:** A demo case is defined as a use case relevant and valuable for INSITER testing needs based on a storyboard representing the full workflow.
- **Assembly Phase:** The process of pre-fabrication of the building parts at factory level.
- **Construction Phase:** The process of constructing the building to meet the criteria established during the design phases and where the building performance as outlined in the construction documents is validated through observations and testing (source: NIBS Guideline 3-2012 Building Enclosure Commissioning Process BECx This Guideline is for Use with ASHRAE Guideline 0-2005: The Commissioning Process, 2012). Within the construction phase all processes related to the placement of pre-fab components at the site are embedded.
- **Maintenance Phase:** The objective is to repair unscheduled and scheduled deficiencies during the time period in which they occur. This includes preventive maintenance for buildings, structures, and installed building equipment (IBE) as recommended by the manufacturer. It also includes engineering and/or contracted Architectural and Engineering (A&E) services that support planning, design and execution of maintenance activities.

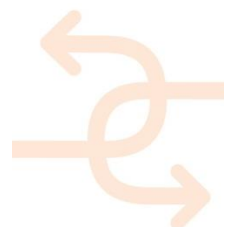



## Fulfilment of the Description of Action (DoA) in D5.3

Accessibility of this deliverable: public

This deliverable is presented in 1 part:

- Report / documentation (this document)

### Fulfilment of WP, Task and Deliverable scope and objectives

Summarised objectives as stated in DoA	Results presented in this deliverable
<p>WP 5 scope and objectives:</p> <ul style="list-style-type: none"> <li>• To test, validate and demonstrate the holistic toolset for self-inspection for use by different stakeholders from architects to engineers, workers/craftsmen and end-users in order to ensure the realisation of the targeted building performance.</li> <li>• To involve the different groups of stakeholders in testing, validation and demonstrations –in conjunction with training, dissemination and exploitation activities in WP6. This is towards embedding validation and demonstration results into dissemination activities, and where possible using validation and demonstration for the start and as a catalyst of dissemination.</li> </ul>	<p>Addressed (please explain to which extent):</p> <ul style="list-style-type: none"> <li>• Storyboards for all 6 demonstrators are created. The objective is to follow and describe the regular workflow on site and demonstrate the intervention for quality assuring by the INSITER methodology and toolset at different phases of the project. The validation will be done on site and is prepared in D5.3 and will be further elaborated in <i>D5.4 Field validation report and recommendations</i>. The test on site will be described in detail in <i>D5.5 Field demonstration set-up</i>, the results of the site testing will be reported in <i>D5.6 Field demonstration report</i> and finally analysed in <i>D5.7 Cross-case analysis and benchmarking</i>.</li> <li>• The storyboards involve all stakeholders and their characteristic demands in order to assure the interaction related to quality issues.</li> <li>• The interaction between WP5 and WP6 <i>Training, communication, dissemination and exploitation</i> is very close and the results of the site testing related to training issues will be embedded in the training modules developed in T6.1.</li> </ul>

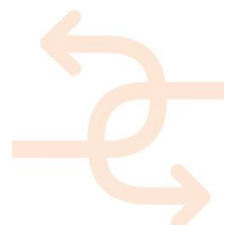

Task 5.2 scope and objectives:

- Validation in new construction and refurbishment
- The field validation will be carried out based on real case studies of new and existing buildings (several projects with similar scales, types and sites).
- Other projects will be selected and used depending on their relevance, relying on the project portfolio of all industrial partners by the INSITER consortium.
- The field validation will address a wide and heterogeneous range of real projects in different execution (construction, refurbishment and maintenance) phases.
- This will allow demonstrating the INSITER tools and methodology using different construction processes as use cases (foundations execution, M&E services installation, envelope execution, etc.).
- The field validation will focus on specific building parts following the results of the lab testing.

Addressed:

- The 6 defined demonstration projects are related to new construction, retrofitting and maintenance and additionally on the finishing prefab-process at factory level as the interface between finishing pre-fab activities at factory level and site delivery has been identified as a relevant quality assurance problem.
- The field validation activities will be further detailed in the upcoming deliverables *D5.4 Field validation report* and recommendations due at M 36. The activities -see storyboards- are manifold and include construction, refurbishment and maintenance. The use cases -defined as demo cases- include different project phases as foundations execution or envelope execution and M&E services installation at the same time.
- The identification of relevant building parts for further investigation has been prepared in WP1 and documented in *D1.4 Calculation and analytical methods for building components* and *D1.6 Calculation and analytical methods for MEP/HVAC components*.

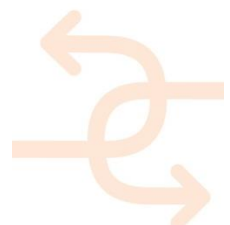

## Table of Contents

Fulfilment of WP, Task and Deliverable scope and objectives	9
<b>1. INTRODUCTION</b>	<b>12</b>
1.1 Objectives and structure of this deliverable	12
<b>2. HEALTH CENTRE COLOGNE, DE</b>	<b>15</b>
2.1 Site characteristics and description	15
2.2 Storyboard	18
2.3 Demo case selection	19
2.3.1 Demo Case 1, scan of QR code	20
2.3.2 Demo Case 2, geometry check of the ground sill	25
2.3.3 Demo Case 3, application of Augmented Reality	28
<b>3. CARTIF-3, ES</b>	<b>30</b>
3.1 Site characteristics and description	30
3.2 Storyboards	33
3.3 Demo case selection	34
3.3.1 Demo Case 1, check and approval of measured values (self-inspection at component level)	36
3.3.2 Demo Case 2, building envelope quality (Self-inspection at building level)	41
3.3.3 Demo Case 3, commissioning of the solar thermal system (Self-inspection & Self-instruction)	44
<b>4. CONCETTO MARCHESI, IT</b>	<b>49</b>
4.1 Site characteristics and description	49
4.2 Storyboards and demo case selection	55
<b>5. HOGEKAMP ENSCHEDE, NL</b>	<b>58</b>
5.1 Site characteristics and description	58
5.2 Storyboards for field demonstration activities and demo cases	66
<b>6. SUSTAINER HOMES, DELFT, NL</b>	<b>68</b>
<b>7. DRAGADOS FACTORY, ES</b>	<b>73</b>
7.1 Site characteristics and description	73
7.2 Storyboard	79
7.3 Demo case selection	79
<b>8. CONCLUSIONS</b>	<b>85</b>
<b>9. APPENDIX 1 – STORYBOARD 1</b>	<b>86</b>
<b>10. APPENDIX 2 – STORYBOARD 2</b>	<b>109</b>
<b>11. APPENDIX 3 – STORYBOARD 3</b>	<b>122</b>
<b>12. APPENDIX 4 – STORYBOARD 4</b>	<b>131</b>
<b>13. APPENDIX 5 – TECHNICAL INFO ABOUT CARTIF-3</b>	<b>138</b>

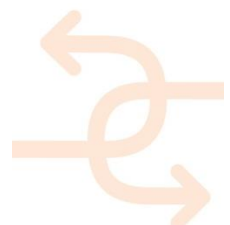

# 1. Introduction

## 1.1 Objectives and structure of this deliverable

The main objectives of this deliverable are to create storyboards for all 6 demonstrators and define demo cases. The storyboards involve all stakeholders and their characteristic demands in order to assure the interaction related to quality issues. The objective of the storyboards is to follow and describe the regular workflow on site and demonstrate the intervention for quality assuring by the INSITER methodology and toolset at different phases of the project. The validation will be done on site and is prepared in D5.3. It will be further elaborated in *D5.4 Field validation report and recommendations*. The test on site will be described in detail in *D5.5 Field demonstration set-up*, the results of the site testing will be reported in *D5.6 Field demonstration report* and finally analysed in *D5.7 Cross-case analysis and benchmarking*. The demo cases are defined and used as samples in order to validate the INSITER tools and methodologies. Related to the quality assuring self-inspection and self-instruction methodology supported by the INSITER tool the testing needs and processes on sites are prepared and pre-defined.

The 6 defined demonstration projects are related to new construction, retrofitting, maintenance and additionally on the finishing prefab-process at factory level as the interface between finishing prefab activities at factory level and site delivery has been identified as a relevant quality assurance problem.



**Demonstrator 1: Health Centre Cologne, D, responsible partner 3L.** The Cologne demonstrator is a roof top extension with prefab light-weight elements on an existing building erected in 2012. This project is defined as a hybrid, because an additional new part of a building will be connected structurally with an existing building without retrofitting it. Field demonstration activities will focus on scanning the QR code, geometric check of the ground sill and application of AR.



**Demonstrator 2: Cartif-3, E, responsible partner Cartif.** Cartif-3 is an existing prefab nearly zero energy research building. It contains large facilities for real scale chemical/industrial prototypes testing and offices. Field demonstration activities will focus on checking of measured values of building components, measurement thermal performance and commissioning of solar thermal systems related to maintenance demands.

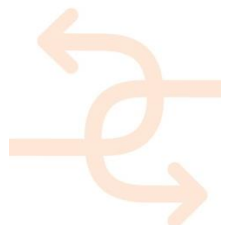



**Demonstrator 3: Concetto Marchesi, I, responsible partner AICE.** The Concetto Marchesi, located in the eastern part of Pisa, is a modular school building from 1974 with a modular construction grid, a precast structure and made of prefabricated components. The building is in poor maintenance condition and therefore deep renovation processes will be performed. Field demonstration activities will focus on geometrical consistency, testing of thermal bridges and checking of the connections between existing building and additions.



**Demonstrator 4: Hogekamp, NL, responsible partner DEMO**  
This demonstrator is the deep retrofit, redesign and transformation of an abandoned university building, originally erected in 1965, into a student hostel and hotel building. The field demonstration activities will focus on the testing and inspection of new facade panels, parts of a new MEP system and a mobile inspection tool for post-renovation condition assessment.



**Demonstrator 5: The Green Village, NL, responsible partner SBR.** Demonstrator 5 will be erected on the campus of the University of Delft. The new prefabricated office building is based on wooden modules. The field demonstration activities will focus on the positioning of the building elements with the help of QR codes, the testing and inspection of air tightness measurement on site and digital VR instruction including dimensions and tolerances facilitating assembly on site.

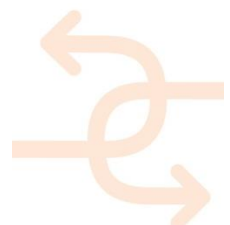



**Demonstrator 6: Dragados Factory, E,  
responsible partner Dragados.**

Demonstrator 6 is containing industrial buildings and workshops where panel and modules are prefabricated, pre-assembled and pre-commissioned since 1974. The most critical processes at factory level affecting the final quality of the final building are the roof and facade panel fabrication and preassembly, the testing of the joints, the installation of the MEP/HVAC components on the modules and the pre-assembly of the modules. The quality/energy performance will be checked, as well.

The interaction between WP5 and WP6 *Training, communication, dissemination and exploitation* is very close and the results of the site testing related to training issues will be embedded in the training modules developed in T6.1. The field validation activities will be further detailed in the upcoming deliverables *D5.4 Field validation report* and recommendations due at M 36. The activities -see storyboards- are manifold and include new construction, refurbishment and maintenance.

The use cases -defined as demo cases- include different project phases as foundations execution or envelope execution and M&E services installation at the same time. The identification of relevant building parts for further investigation has been prepared in WP1 and documented in *D1.4 Calculation and analytical methods for building components* and *D1.6 Calculation and analytical methods for MEP/HVAC components*. Deliverables D1.4 and D1.6 (M24) were done in parallel and are dedicated to the building and MEP-HVAC components.

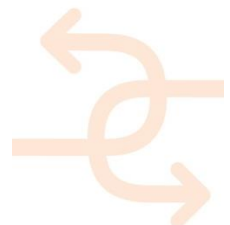

## 2. Health Centre Cologne, DE

### 2.1 Site characteristics and description

The site is located in Cologne, West Germany. The rooftop extension is planned upon the 2<sup>nd</sup> floor of the existing building as the 3<sup>rd</sup> floor. The loads of the additional storey with a total floor space of approx. 800 m<sup>2</sup> were already pre-calculated when the building stock was erected in 2012 and the staircase and the elevator were already prepared by that time, as well.



Figure 1: Existing building

There are particular demands for the construction process, because the existing flat roof insulation will have to be removed before the new construction can be placed. The construction process is depending on the weather and the new storey will be erected while all the business in the existing building will not be stopped. So there is a strong need for a very swift construction process in order to minimise the sound disturbance and the risk of water ingress. The rooftop construction will be lightweight prefab external walls for high performance thermal and sound insulation. The walls and the new roof will be mounted on a primary steel construction.

Through the existing road network transportation of the building elements to the site is guaranteed. There is not much space to store the building elements on the site. Therefore it is planned to preferably not store the building elements on site but to unload them from a truck by using a mobile crane and directly mount them in final place.

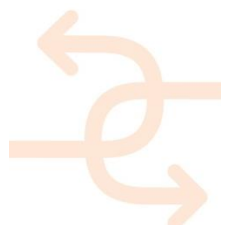
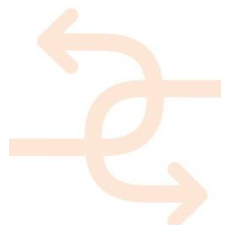



Figure 2: elevations planned rooftop extension (green)



Figure 3: floorplan planned rooftop extension (green)





(Remark: The purpose of the inventory list is to gain general information from the demonstrators with regard to their qualification for testing needs. Further data are stored on the share point.)

no		3						
name		Extension Health Centre Cologne						
country		Germany						
year of completion		2016						
volume m <sup>3</sup>		3.927						
number of storeys		1						
new/existing		extension						
use		health						
		available data						
				2D analog	2D digital	3D digital	BIM	other
construction exterior walls	input from	metal	<input checked="" type="checkbox"/>	<input checked="" type="checkbox"/>	<input type="checkbox"/>	<input type="checkbox"/>	<input type="checkbox"/>	<input type="checkbox"/>
window frame material		aluminium	<input checked="" type="checkbox"/>	<input checked="" type="checkbox"/>	<input type="checkbox"/>	<input type="checkbox"/>	<input type="checkbox"/>	<input type="checkbox"/>
door frame	T1.2	aluminium	<input checked="" type="checkbox"/>	<input checked="" type="checkbox"/>	<input type="checkbox"/>	<input type="checkbox"/>	<input type="checkbox"/>	<input type="checkbox"/>
	input from	drinking water	<input checked="" type="checkbox"/>	<input checked="" type="checkbox"/>	<input checked="" type="checkbox"/>	<input type="checkbox"/>	<input type="checkbox"/>	<input type="checkbox"/>
		heating water	<input checked="" type="checkbox"/>	<input checked="" type="checkbox"/>	<input checked="" type="checkbox"/>	<input type="checkbox"/>	<input type="checkbox"/>	<input type="checkbox"/>
		ventilation	<input checked="" type="checkbox"/>	<input checked="" type="checkbox"/>	<input type="checkbox"/>	<input type="checkbox"/>	<input type="checkbox"/>	<input type="checkbox"/>
		electric cable	<input checked="" type="checkbox"/>	<input checked="" type="checkbox"/>	<input type="checkbox"/>	<input type="checkbox"/>	<input type="checkbox"/>	<input type="checkbox"/>
		light switch	<input checked="" type="checkbox"/>	<input checked="" type="checkbox"/>	<input type="checkbox"/>	<input type="checkbox"/>	<input type="checkbox"/>	<input type="checkbox"/>
		plug socket	<input checked="" type="checkbox"/>	<input checked="" type="checkbox"/>	<input type="checkbox"/>	<input type="checkbox"/>	<input type="checkbox"/>	<input type="checkbox"/>
test applicability		air leakage	<input checked="" type="checkbox"/>	<input type="checkbox"/>	<input type="checkbox"/>	<input type="checkbox"/>	<input type="checkbox"/>	<input type="checkbox"/>
		performance monitoring	<input checked="" type="checkbox"/>	<input type="checkbox"/>	<input type="checkbox"/>	<input type="checkbox"/>	<input type="checkbox"/>	<input type="checkbox"/>
		joint security	<input checked="" type="checkbox"/>	<input type="checkbox"/>	<input type="checkbox"/>	<input type="checkbox"/>	<input type="checkbox"/>	<input type="checkbox"/>
		material check	<input checked="" type="checkbox"/>	<input type="checkbox"/>	<input type="checkbox"/>	<input type="checkbox"/>	<input type="checkbox"/>	<input type="checkbox"/>
		overall system check	<input checked="" type="checkbox"/>	<input type="checkbox"/>	<input type="checkbox"/>	<input type="checkbox"/>	<input type="checkbox"/>	<input type="checkbox"/>
		other (please comment)	<input type="checkbox"/>	<input type="checkbox"/>	<input type="checkbox"/>	<input type="checkbox"/>	<input type="checkbox"/>	<input type="checkbox"/>
test applicability construction phase		laboratory	<input type="checkbox"/>	<input type="checkbox"/>	<input type="checkbox"/>	<input type="checkbox"/>	<input type="checkbox"/>	<input type="checkbox"/>
		factory	<input type="checkbox"/>	<input type="checkbox"/>	<input type="checkbox"/>	<input type="checkbox"/>	<input type="checkbox"/>	<input type="checkbox"/>
		on site	<input checked="" type="checkbox"/>	<input type="checkbox"/>	<input type="checkbox"/>	<input type="checkbox"/>	<input type="checkbox"/>	<input type="checkbox"/>
		maintenance	<input type="checkbox"/>	<input type="checkbox"/>	<input type="checkbox"/>	<input type="checkbox"/>	<input type="checkbox"/>	<input type="checkbox"/>
special requirements regarding site logistics		yes (please comment below)	<input type="checkbox"/>	<input type="checkbox"/>	<input type="checkbox"/>	<input type="checkbox"/>	<input type="checkbox"/>	<input type="checkbox"/>
time schedule		available (provide format)	xls					
Site logistics: the running business in the building has to be assured.								

Figure 4: Inventory list

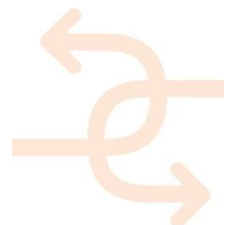

**2.2 Storyboard**

The main objectives of this deliverable are to create storyboards for all 6 demonstrators and define demo cases. The storyboards involve all stakeholders and their characteristic demands in order to assure the interaction related to quality issues. The objective of the storyboards is to follow and describe the regular workflow on site and demonstrate the intervention for quality assuring by the INSITER methodology and toolset at different phases of the project. The storyboards are working documents including comments of involved partners. See the storyboard for the Cologne case below:

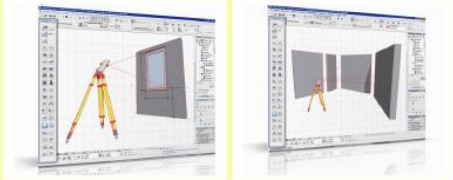
Chronological storyline representing a specific on-site construction activity	Content to be presented or demonstrated	Demonstration action at Ancona meeting	Responsible partner	
<b>On-site preparation</b>				
1	<ul style="list-style-type: none"> <li>- Checking the panels delivered on building site</li> <li>- RFID and QR in prefab panels</li> <li>- Retrieval of component's ID in BIM</li> </ul> <p>For example:</p> 	<ul style="list-style-type: none"> <li>- 1 presentation slides with illustrations</li> <li>- 1 presentation slide with illustrations</li> </ul>	<ul style="list-style-type: none"> <li>- 3L</li> <li>- HVC</li> </ul>	
<b>Self-instruction</b>				
2	<ul style="list-style-type: none"> <li>- Handling of the panels on the building site (storing, lifting, positioning)</li> </ul> <p>Example of 'assembly manual' from a prefab panel supplier</p> <p>For example: <a href="https://www.youtube.com/watch?v=hK5IuZSLwY">https://www.youtube.com/watch?v=hK5IuZSLwY</a></p>	1 short video example	3L	
3	<ul style="list-style-type: none"> <li>- Loading the partial BIM model onto a tablet or smartphone, showing the specific parts of the façade including the panels</li> </ul>	<ul style="list-style-type: none"> <li>- Loading BIM model of Cologne case onto iPad; viewing the relevant building parts or components</li> </ul>	Recorded software demonstration of this activity	DEMO (Richard)
4	<ul style="list-style-type: none"> <li>- Installation process of the façade panels of the new storey (roof top extension)</li> </ul>	<ul style="list-style-type: none"> <li>- Animation of the panel installation using BIM of Cologne case, similar to the insulation panel installation at the 'refrigerator'</li> </ul>	Short animation	FHG-IPA
<b>Work-in-progress</b>				
5	<ul style="list-style-type: none"> <li>- Construction workers assembling the prefab panels on-site</li> </ul> <p>For example: <a href="https://www.youtube.com/watch?v=fOOHHcuWIRs">https://www.youtube.com/watch?v=fOOHHcuWIRs</a></p>	<ul style="list-style-type: none"> <li>- An example of an existing video about prefab panel assembly on-site</li> </ul>	Short video example, for instance	3L
<b>Self-inspection at the level of building component</b>				
6	<ul style="list-style-type: none"> <li>- Check whether the panels are 'perfectly' aligned; check the gaps between panels and at the joints panels and floor slabs</li> </ul> <p><i>Remark from Giuseppe (UNIVPM): We don't have available the 3D laser scanner, if CARTIF wants to send the equipment there are no problems for us otherwise CARTIF could be produce a demo on CARTIF-3 Building</i></p> <p>For example: <a href="https://www.youtube.com/watch?v=14RAH9UTDEY">https://www.youtube.com/watch?v=14RAH9UTDEY</a> or <a href="http://www.stramien.nl/sites.php?fb=news_showitem&amp;sid=22">http://www.stramien.nl/sites.php?fb=news_showitem&amp;sid=22</a> or <a href="http://www.flexijet.info/en/products/flexijet-4architects/the-flexijet-4architects/">http://www.flexijet.info/en/products/flexijet-4architects/the-flexijet-4architects/</a></p> 	<ul style="list-style-type: none"> <li>- Use of laser measuring / alignment tool.</li> </ul> <p>If the device is available at UNIVPM, then demonstrate in lab; if not, then 1-2 presentation slides or a short movie.</p>	UNIVPM, CARTIF	

Colour-marking codes of the required preparation and actions:

- Blue: presentation / illustration / video from reference materials or literature
- Red: recorded software presentation or BIM showcase
- Yellow: live demonstration using devices in the lab

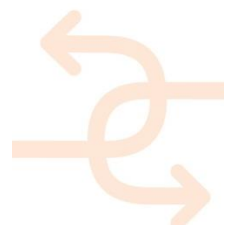

7	Insert the measured values in the software, and store this data	Show this functionality / feature in the WP3 software	Recorded software demonstration of this activity ; if not possible, then 1 presentation slide showing the proposed software feature with 'mock-up screenshots'	DEMO (Richard)
8	Check if the measured values (i.e. the sizes of the gaps) are acceptable (within the tolerance) for: - individual gaps between panels - cumulative gaps in the case of a series of panels	Show this functionality / feature in the WP3 software (e.g. validation of measured values against 'range limits' or 'threshold limits')	1 presentation slide showing the proposed software feature with 'mock-up screenshots'	DEMO (Richard)
9	Approval and decision-making supported by the software	Show functionality included in the WP3 software - If the 'validation' is OK, then self-approval by workers - If the 'validation' is not OK, then send an inquiry to the site supervisor	1-2 presentation slides showing the proposed software feature with 'mock-up screenshots'	DEMO (Richard)
<i>Iteration of the work (steps 5 – 9) until all panels are placed, and the façade is completed (closed façade)</i>				
<i>Self-inspection at the level of room or building section</i>				
10	Measurement of the thermal performance (thermal transmittance) of the façade	Measure the actual U-value of a part of the façade after on-site assembly	Real demonstration of the use of thermal measurement device on the panel of the 'refrigerator' in UNIVPM lab	UNIVPM
11	Insert the measured values in the software, and store this data	Show functionality included in the WP3 software	1-2 presentation slides showing the proposed software feature with 'mock-up screenshots'	DEMO (Richard)
12	Check if the measured values are acceptable	Show this functionality / feature in the WP3 software (e.g. validation of measured values against 'range limits' or 'threshold limits')	1-2 presentation slides showing the proposed software feature with 'mock-up screenshots'	DEMO (Richard)
13	Approval and decision-making supported by the software	Show functionality included in the WP3 software - If the 'validation' is OK, then self-approval by workers - If the 'validation' is not OK, then send an inquiry to the site supervisor	1-2 presentation slides showing the proposed software feature with 'mock-up screenshots'	DEMO (Richard)
14	Update of the BIM model >> creation of "as-built BIM"	Generating an updated BIM model that contains measured data, including geometric revisions in case of discrepancies between design and assembly	1-2 presentation slides showing our proposed solution	HVC
15	Generation of a list of adjusted objects or specifications based on the comparison between "pre-built BIM" and "as-built BIM"	Model checking and versioning	1-2 presentation slides or a recorded software demonstration of BIM comparison / versioning	HVC

Figure 5: storyboard 1, Cologne demonstrator

### 2.3 Demo case selection

The most relevant cases have been identified by the involved partners. The idea is to perform testing, validation and training for self-inspection and self-instruction on at least 3 demo cases per demonstrator.

The foreseen field demonstration activities for the Cologne demonstrator will focus on the following demo cases:

1. scanning the QR code
2. geometric check of the ground sill
3. application of AR for self-instruction needs.



2.3.1 Demo Case 1, scan of QR code

The facade panels are delivered on site and the QR codes on the panels are scanned to compare the information from the delivered panel and the design information (see description of storyboard 1, prefab facade system for rooftop extension, step 1: check panels on building site - see APP. 1). It is important to identify and to localise the panels in order to check the right positioning. Furthermore this information will be used for maintenance oriented documentation issues.





Figure 6: scanning of QR code

Expectation:	consistency of the data
Threshold:	according to producer/system requirements
Equipment:	e.g. Tablet, Smartphone with QR code application for each case pinpoint which instruments will be used and to which extent

INSITER solution: checking procedure, INSITER tool application e.g. BIM/existing overlay

Result:

-  not OK
-  possibly ok
-  OK

Follow-up actions:

-  action needed
-  action possibly needed
-  continue assembly process

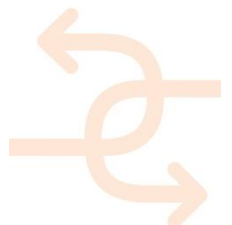

## The context

Within Demonstrator 1 – the Health Care Centre, Cologne – three critical construction topics have been identified. The INSITER toolset should be tested and validated regarding following issues:

1. Prefabricated façade system for rooftop extension,
2. Joints and critical insulations at connection between the original roof and new façade panels,
3. MEP system on the new roof.

To prepare the INSITER toolset for the aimed use cases it is essential to describe the proposed processes in detail. Therefore, storyboards for each of the above-mentioned issues have been created. These storyboards are describing all actions related to the INSITER toolset in the given construction situations. This will enable the INSITER project to adjust the required software functionalities and to prepare the BIM models as well as the IT environment in a most suitable way.

## Short description of Use Case 1

Use Case 1 handles the placement of prefabricated exterior wall panels of the rooftop extension. The storyboard is divided into five phases that are:

1. On-site preparation
2. Self-instruction
3. Work-in-progress
4. Self-inspection at the level of building component
5. Self-inspection at the level of room or building section

Phase 1 is referring to the on-site preparation using the INSITER toolset to check the delivered panels on building site via QR codes. It is intended that the site workers are scanning the facade panel with a mobile device using the INSITER toolset. The software will automatically connect to the INSITER servers and fetch all related information regarding this specific panel.

The site-worker will check the delivered goods, compare them to the defined products in the design documents and immediately communicate any discrepancies. This guarantees the usage of correct components and – in case of delivery of wrong or damaged products – the initiation of countermeasures without loss of time – see deliverables D1.1 Best practices and existing shortcomings, D1.4 Calculation and analytical methods for building components, D1.6 Calculation and analytical methods for MEP/HVAC components.

To realise the described functionalities adjustments have to be made regarding common processes at the stage of planning and modelling, at the factory as well as on site. The following figure represents the general process steps to enable an on-site check of delivered goods via QR-code.

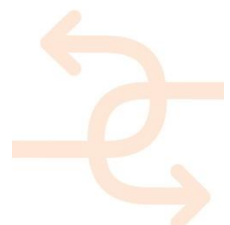

Step	System	Description	Output / Follow-Up Actions
1	CAD	Creation of BIM models: <ul style="list-style-type: none"> <li>- overall project model with attribute about reference to specific panel version</li> <li>- detail model of specific prefabricated panel linked to project model</li> </ul>	Export BIM model to IFC2x3 TC1
2	Share Point	Upload IFC-models to SharePoint and initiate workflow <i>Required to</i> <ul style="list-style-type: none"> <li>- <i>initiate workflow and</i></li> <li>- <i>enable version tracking (History of Models) and</i></li> <li>- <i>do version comparison</i></li> </ul>	Workflow: <ul style="list-style-type: none"> <li>-&gt; Copy current models to BIM Server</li> <li>-&gt; Prepare PostgreSQL according to BIM elements` GUIDs</li> <li>-&gt; Generate QR-code from GUIDs</li> <li>-&gt; Request upload of design documents automatically</li> <li>-&gt; Order required prefabricated panel</li> </ul>
3	Factory	Production of prefabricated panels, Retrieve QR code from SharePoint when ready to deliver	When retrieving the QR code SharePoint requests required production documents
4	On Site	Delivery of prefabricated panels with attached QR code Scan QR code with mobile device	Software-interface options: <ul style="list-style-type: none"> <li>- Retrieve detail model</li> <li>- Retrieve overview model</li> <li>- Retrieve documents (design &amp; production documents)</li> <li>- Check: comparison of delivered panels and design specifications</li> </ul>
5	Software Check	Compare delivered prefabricated panels information and design information	Results: <ol style="list-style-type: none"> <li>1. OK -&gt; approval / continue</li> <li>2. Mismatch -&gt; forward information to project manager for decision making               <ol style="list-style-type: none"> <li>a) Approval from PM: continue</li> <li>b) Denial from PM: further Decisions</li> </ol> </li> </ol>

Figure 7: general process steps to enable an on-site check of delivered goods via QR-code

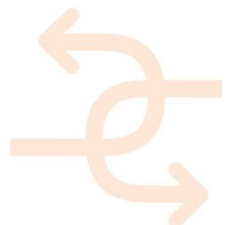

**Planning & Modelling**

The overall process starts with creating a general project BIM model in CAD systems. This model contains simple 3D objects representing all building objects at a low level of detail to give an overview of the project. In addition to this, detailed models of the several types of panels at high level of detail will be created and linked to the specific elements of the overview model. This will enable high performance while navigating through the overview model and provide specific information through the linked detail models. The link will be established through the GUID of the objects on the PostgreSQL Server. Subsequent the models will be uploaded to the SharePoint and copied to the BIM server if they are in IFC format.

**INSITER Server Environment / SharePoint workflow**

When uploading new data to the SharePoint an automatically workflow will be initiated which triggers following actions:

1. SharePoint requests the upload of all related design documents automatically. Drawings, instruction manuals and further information will be stored directly on the SharePoint server.
2. For each detail model of the prefabricated panels a QR code will be created and stored on SharePoint automatically. This will serve as a reference to the specific PostgreSQL entry.
3. The specific links to the BIM models and to the related design documents will be stored on an INSITER server to enable opening the correct 3D models and retrieving further information.
4. To make the most current version of the models available online the latest version will be forwarded to the Open Source BIM server automatically by the SharePoint workflow.

Note: the current models are stored on the Open Source BIM server, while all versions are stored on SharePoint to provide a history of the models and to enable version checking.

5. The last step of the automatically initiated workflow is an order placement of the specific prefabricated panel at the factory.

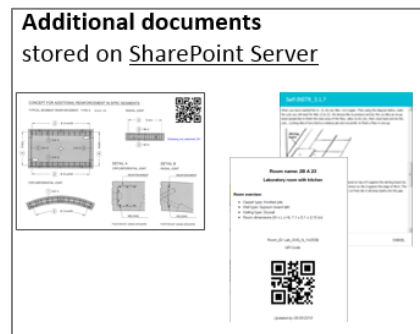

**Building Component information stored on INSITER Server**

Material	concrete C30
Fire Resistance	F 90
Lamda	0.0024
4D sequence	Sequence 1
assembly location definition	X/Y/Z

Link to	Report
Link to	Picture 1
Link to	Picture 2
Link to	assembly instruction document
Link to	specification document

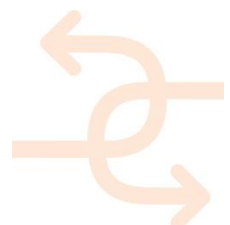
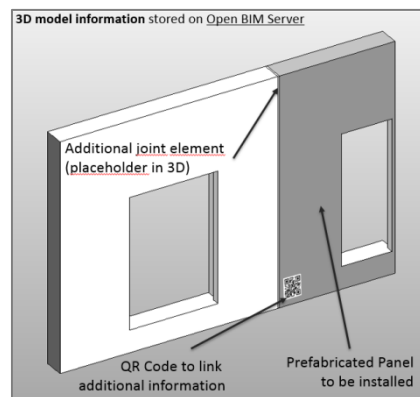

**Factory**

At the factory the panel will be produced and quality checked. When it is ready for delivery the related QR code will be downloaded from SharePoint. At this point SharePoint requests the upload of all required production information (certificates, product specifications, quality check protocols). After successfully uploading all required documents a contact person on site will receive an email that production has been finished and when the expected time of delivery will be. This enables the workers to prepare onsite the delivery of the panels.

**On Site**

As soon as the prefabricated panels arrive on site, the site worker will scan the attached QR-code via the INSITER toolset software by using a mobile device. The software connects to the INSITER servers and provides all available information (design documents and production documents). This will enable the site worker to check if the delivered panel is in line with the expected product according to the design.

In case the prefabricated panel does not match the given design specifications or has been damaged while transporting from factory to site, the site worker will be able to communicate this issue via the INSITER toolset software and all related persons will be contacted. This enables the project team to initiate countermeasures immediately and to keep loss of time and costs at a low grade.

The following figure represents the relation of the above-mentioned systems and locations:

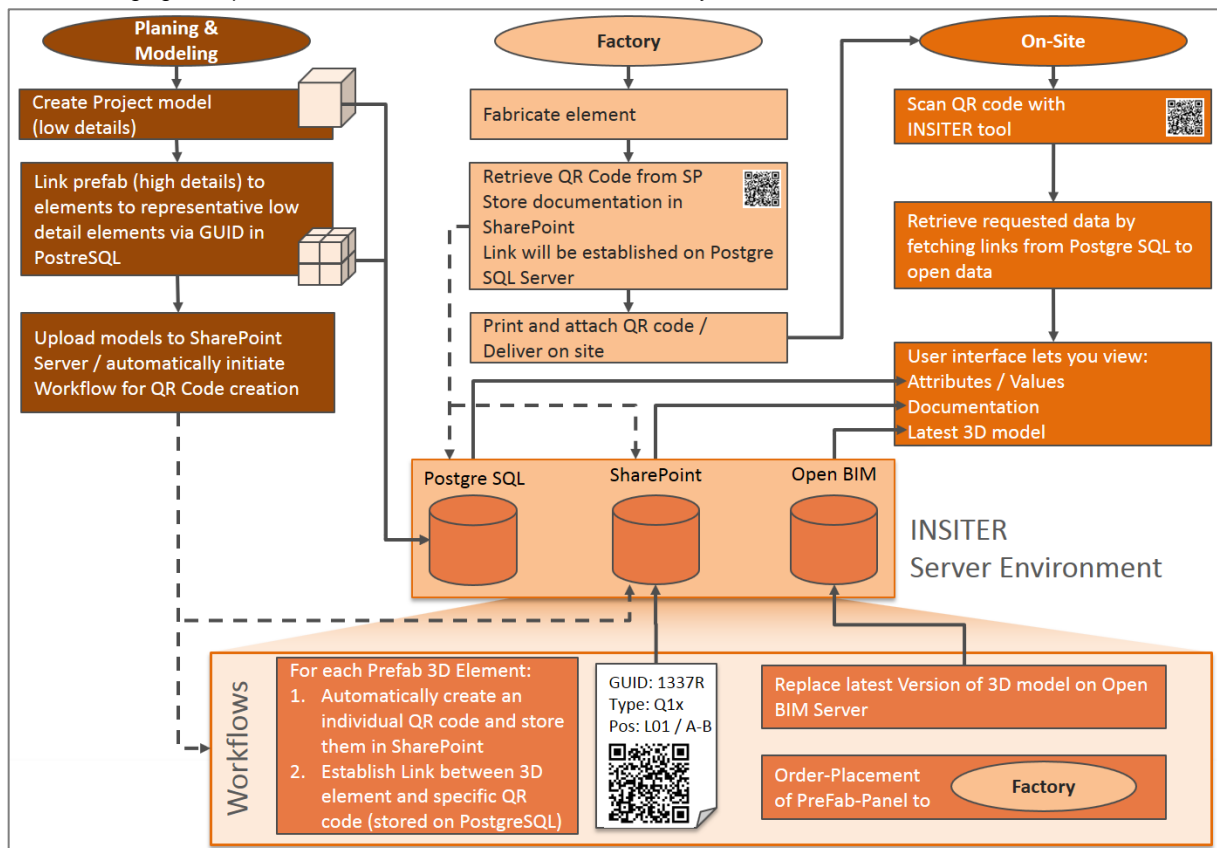

Figure 8: relation of systems and locations





2.3.2 Demo Case 2, geometry check of the groundsill

The facade panels will be mounted on a groundsill or sole-piece. These sole pieces must have a predefined minimum geometrical accuracy to enable a correct mounting of the panels (see storyboard no 1, prefab facade systems for rooftop extension, step 2: positioning of the panels). It is important to reassure the right positioning of the panels at groundsill level as tolerances at this level cause growing geometric deviations.



Figure 9: groundsill (example)

Expectations:

- geometrical accuracy to size:

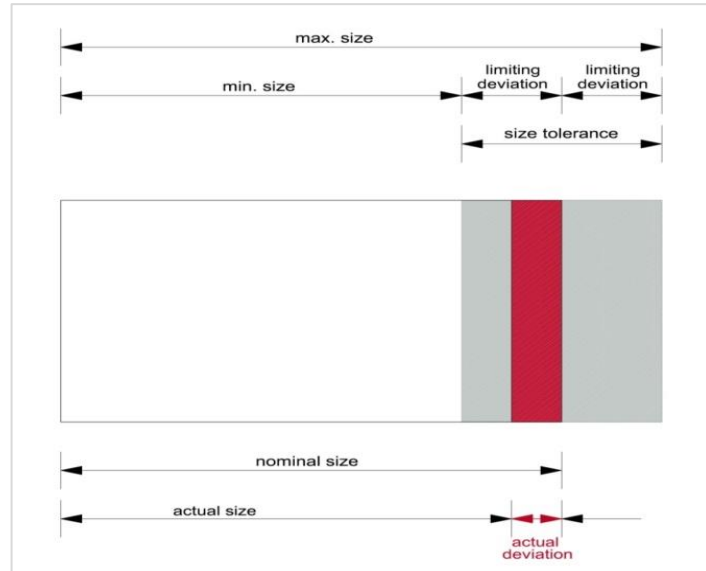

- geometrical accuracy to angular alignment:

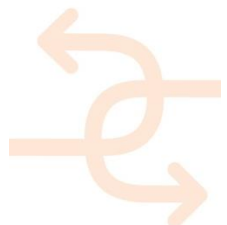
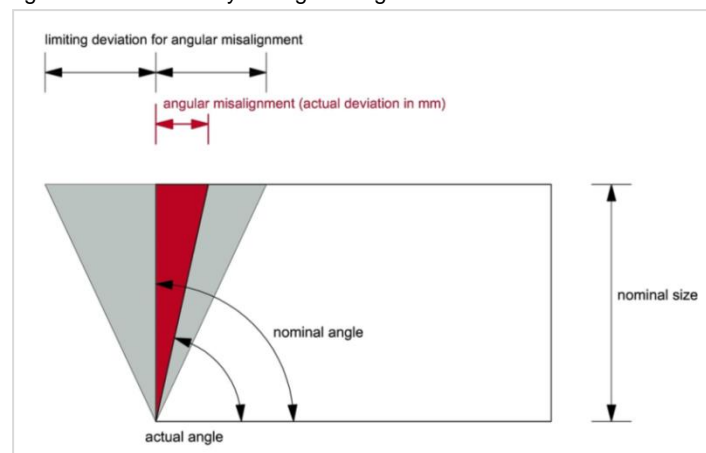

- geometrical accuracy to flatness:

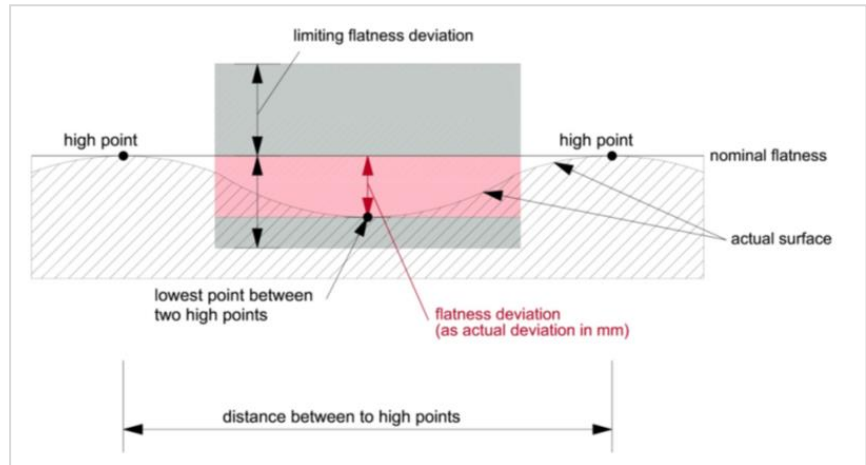

- geometrical accuracy to alignment:

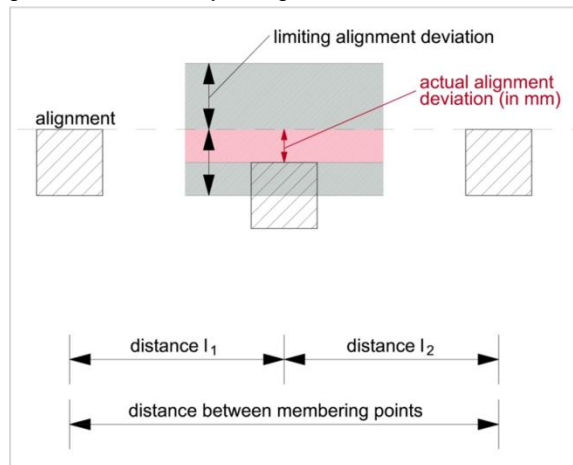

Threshold:

according to producer/system requirements; e.g. angular misalignment  $\leq$  "3 mm"

limiting deviations for angular misalignment DIN 18202							
	nominal sizes $\leq 0,5$ m	nominal sizes $>0,5$ m and $\leq 1$ m	nominal sizes $>1$ m and $\leq 3$ m	nominal sizes $>3$ m and $\leq 6$ m	nominal sizes $>6$ m and $\leq 15$ m	nominal sizes $>15$ m and $\leq 30$ m	nominal sizes $>30$ m and $<60$ m
floor surfaces, ceiling surfaces, wall surfaces, surfaces in stage, surfaces of building elements	3 mm	6 mm	8 mm	12 mm	16 mm	20 mm	30 mm

Figure 10: limiting deviations for angular misalignment according to DIN 18202

Equipment:

e.g. laser scanner for each case pinpoint which instruments will be used and to which extent

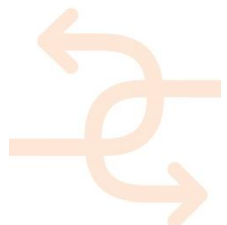

INSITER solution:

checking procedure, INSITER tool application e.g. BIM/existing overlay



Result:



not OK



possibly ok



OK

Follow-up actions:



action needed



action possibly needed



continue assembly process

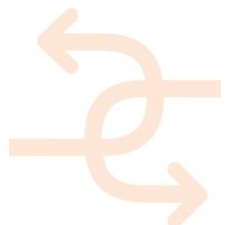

### 2.3.3 Demo Case 3, application of Augmented Reality

Within Demonstrator 1 – Health Care Centre, the INSITER Augmented Reality (AR) prototype application will be applied by the project manager, architects or construction engineers to visualize 3D BIM models and related planning data. One aspect is the use of the provided data for construction instruction or evaluation with a special emphasis on design and construction consistency of dedicated building elements and prefabricated panels with the help of AR.

Within the use cases, the focus is on BIM-based visualizations of 3D IFC models on the construction site with the available AR prototype application at this stage of development.

During the construction of the new rooftop extension the AR application will be applied for development tests, validation and demonstration. The executed tasks and functionalities to be applied will focus on:

- IFC 3D data visualization that is associated with a feature rich scene, initialized by an AR marker, visualized in superimposition (3D model overlay – see figure 11 below)
- Visualization of BIM-referenced information, such as additional metadata or planning data linked to IFC 3D model (e.g. PDF documents) as well as available instrumentation device data and others.

Data to be accessed within this demo case will be the use case IFC 3D-models, IFC model parameters, additional annotations or metadata provided by partners via the INSITER BIM server and database. Moreover, the overall performance of the developed AR application will be evaluated. During the on-site tests the implemented computer vision based tracking technology is applied and demonstrated.



Figure 11: Planned BIM-Model AR visualization of the INSITER use case demo in Cologne (example image)

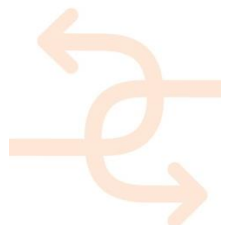

Further visualization of external planning documents (PDF, etc.) on file share systems (e.g. SharePoint) linked within the BIM model (part/object) as references is foreseen during development of the INSITER toolset as well.

Within the demonstration and evaluation workflow on-site, the stakeholders will evaluate the delivered building elements and compare them to the defined IFC objects for self-instruction concerning the correct location and construction of dedicated building elements and prefabricated façade elements as well as evaluation of possible construction errors and inconsistencies. The following main steps have been identified to be conducted during the demo case.

Step	System	Description	Output / Follow-Up Actions
1	AR	Retrieval of BIM Model: - The IFC model with building objects will be accessed from INSITER BIM server, made available and processed for the current AR prototype.	IFC BIM model made available for AR software workflow and interface options: - Retrieve IFC model - Selected IFC model object for current viewpoint - Retrieval of available additional metadata or planning information
2	AR	Set up AR Scene: - Set up tracking system, reference AR marker within the BIM model - Start computer vision based feature tracking and access related BIM objects	Software workflow and interface options: - Initialization of the tracking system - Generation of feature map and reference models for the computer vision based tracking system
3	AR	Apply AR Application - Start superimposed IFC 3D data visualization (3D model overlay) - Evaluate the delivered building elements and compare them to the IFC data objects - Visualization of available BIM-referenced information, such as additional metadata or planning data linked to IFC 3D model.	Workflow: - Visualize current on-site scene with digital 3D BIM IFC building components and available planning information or metadata. - Use of provided data for prefabricated panels construction instruction or evaluation. - Evaluate defined IFC objects and prefabricated façade panels concerning e.g. the correct location and construction position - Analyse possible construction errors and identify inconsistencies.

Figure 12: Main steps for application of AR

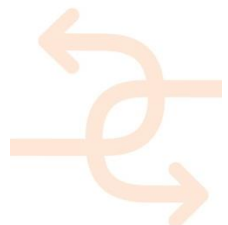

## 3. Cartif-3, ES

### 3.1 Site characteristics and description

CARTIF-3 is a building made of prefabricated panels located in the Boecillo's Technology Park (Valladolid, Spain), under a Mediterranean-Continental Climate having 4.075 m<sup>2</sup> of floor space for CARTIF Technology Centre research activities: one quarter for offices and three quarters for industrial activities (as testing facilities). It is a very low energy building, which integrates many solutions for energy saving and to improve the overall energy efficiency.

Field demonstration activities will focus on checking of measured values of building components, measurement thermal performance and commissioning of solar thermal systems related to maintenance demands. CARTIF-3 building has been designed to have several industrial activities zones and some offices for RTD tasks of CARTIF. So, there are four industrial areas of 3140 m<sup>2</sup> and an office area of 935 m<sup>2</sup>. The main façade is south oriented, with almost the entire cover-up and the entire south-west side closed with a glass wall that improves solar gain and a blind with oriented louvers, fixed to optimize the daylight use, avoiding glare.

The buildings has a basement, a ground floor and a first floor, but not in the whole plant, as some of the industrial zones were designed as cathedral ceiling or double height. It was designed as a very low energy building, and integrating a lot of energy saving solutions and high overall energy efficiency, achieving an annual primary energy demand below 60kWh/m<sup>2</sup>year. The design has sought the most optimal combination of several factors such as the weather, activities, size, economic or local regulations.

The envelope has been designed to minimize thermal energy such as heating and cooling and light electrical demand through a special concept (glass wall and louvers blinds) that allows an important use of daylight with high solar gain and reduces thermal requirements and a high insulation in the different elements of the envelope.

The following solutions are integrated to save energy and to improve the overall energy efficiency:

1. The envelope, already mentioned, was designed to minimize energy thermal and light electrical demand through a special concept (glass wall and louvers blinds) that permits a high solar gain to reduce thermal requirements and also an important use of daylight.
2. A polygeneration renewable energy facility, designed as a combination of thermal plants that will ensure high efficiency, energy balances between winter and summer periods (by means of the use of the ground storage capacity) and zero CO<sub>2</sub> emissions. This solution uses a geothermal and biomass integrated system. The geothermal energy is being used in reversible heat pumps in a seasonal operation in order to achieve zero requirements of thermal energy and offices zone. The biomass boiler supports the peaks of heating and hot water demand in the rest of the energy needs, heating for industrial zones and hot water.

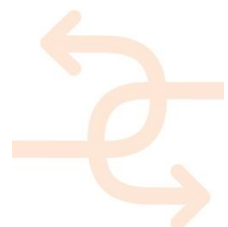

3. A PV plant is installed on the top roof in order to supply an important portion of the total electricity consumption. The 45 kWp solar PV plant has been designed to supply about 63.000 kWh per year, a very significant portion of the electricity consumed.
4. High efficiency lighting equipment.
5. An advanced building management systems (BMS) that optimizes energy uses by means of an efficient distribution and final use of the overall energy involved in each system and process. This system allows not only reading but also storing monitoring information in the data base.



*Figure 13: CARTIF-3 building; made of prefabricated modules, real scale prototypes testing facilities (chemical and industrial processes) nZEB*

Then the descriptive sheet of this building is given according to the inventory established in WP5 (Validation and Demos).

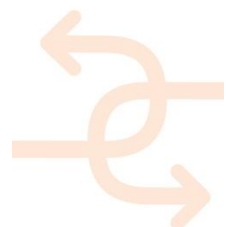

(Remark: The purpose of the inventory list is to gain general information from the demonstrators with regard to their qualification for testing needs. Further data are stored on the share point.)

INSITER INTUITIVE SELF-INSPECTION TECHNIQUES											
WP5 inventory list											
no	3										
name	CARTIF-3										
country	Spain										
year of completion	2011										
volume m <sup>3</sup>	26.224										
number of storeys	4										
new/existing	new construction										
use	office										
		available data									
		<table border="1"> <thead> <tr> <th>2D analog</th> <th>2D digital</th> <th>3D digital</th> <th>BIM</th> <th>other</th> </tr> </thead> </table>					2D analog	2D digital	3D digital	BIM	other
2D analog	2D digital	3D digital	BIM	other							
construction exterior walls (*)	input	concrete	<input checked="" type="checkbox"/>	<input checked="" type="checkbox"/>	<input checked="" type="checkbox"/>	<input type="checkbox"/>	<input checked="" type="checkbox"/>				
window frame material	from	aluminium	<input checked="" type="checkbox"/>	<input checked="" type="checkbox"/>	<input checked="" type="checkbox"/>	<input type="checkbox"/>	<input checked="" type="checkbox"/>				
door frame	T1.2	aluminium	<input checked="" type="checkbox"/>	<input checked="" type="checkbox"/>	<input checked="" type="checkbox"/>	<input type="checkbox"/>	<input checked="" type="checkbox"/>				
	input	drinking water	<input checked="" type="checkbox"/>	<input type="checkbox"/>	<input checked="" type="checkbox"/>	<input type="checkbox"/>	<input checked="" type="checkbox"/>				
	from	heating water (**)	<input type="checkbox"/>	<input type="checkbox"/>	<input type="checkbox"/>	<input type="checkbox"/>	<input type="checkbox"/>				
	T1.3	ventilation (**)	<input type="checkbox"/>	<input type="checkbox"/>	<input type="checkbox"/>	<input type="checkbox"/>	<input type="checkbox"/>				
		electric cable	<input checked="" type="checkbox"/>	<input checked="" type="checkbox"/>	<input checked="" type="checkbox"/>	<input type="checkbox"/>	<input checked="" type="checkbox"/>				
		light switch	<input checked="" type="checkbox"/>	<input checked="" type="checkbox"/>	<input checked="" type="checkbox"/>	<input type="checkbox"/>	<input checked="" type="checkbox"/>				
		plug socket	<input checked="" type="checkbox"/>	<input checked="" type="checkbox"/>	<input checked="" type="checkbox"/>	<input type="checkbox"/>	<input checked="" type="checkbox"/>				
test applicability (***)		air leakage	<input checked="" type="checkbox"/>	<input type="checkbox"/>	<input type="checkbox"/>	<input type="checkbox"/>	<input type="checkbox"/>				
		performance monitoring	<input checked="" type="checkbox"/>	<input type="checkbox"/>	<input type="checkbox"/>	<input type="checkbox"/>	<input type="checkbox"/>				
		joint security	<input checked="" type="checkbox"/>	<input type="checkbox"/>	<input type="checkbox"/>	<input type="checkbox"/>	<input type="checkbox"/>				
		material check	<input checked="" type="checkbox"/>	<input type="checkbox"/>	<input type="checkbox"/>	<input type="checkbox"/>	<input type="checkbox"/>				
		overall system check	<input checked="" type="checkbox"/>	<input type="checkbox"/>	<input type="checkbox"/>	<input type="checkbox"/>	<input type="checkbox"/>				
		other (***)	<input checked="" type="checkbox"/>	<input type="checkbox"/>	<input type="checkbox"/>	<input type="checkbox"/>	<input type="checkbox"/>				
test applicability construction phase		laboratory	<input type="checkbox"/>	<input type="checkbox"/>	<input type="checkbox"/>	<input type="checkbox"/>	<input type="checkbox"/>				
		factory	<input type="checkbox"/>	<input type="checkbox"/>	<input type="checkbox"/>	<input type="checkbox"/>	<input type="checkbox"/>				
		on site	<input checked="" type="checkbox"/>	<input type="checkbox"/>	<input type="checkbox"/>	<input type="checkbox"/>	<input type="checkbox"/>				
		other (please comment)	<input type="checkbox"/>	<input type="checkbox"/>	<input type="checkbox"/>	<input type="checkbox"/>	<input type="checkbox"/>				
special requirements regarding site logistics	no										
time schedule	not available										
		e.g. xlsx									

Figure 14: Inventory list



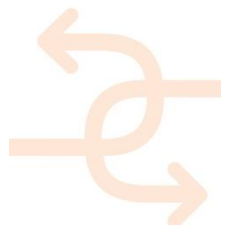

Comments to inventory list:

(\*) The wall is made by concrete, brick and metal sheet/layer.

(\*\*) Heating water system is placed in the floor. Ventilation systems are located in the roof.

(\*\*\*) Apart from the monitoring data, which are quite extensive, there are KPIs divided into 3 categories: comfort (usual and operative thermal, CO2...), energy performance for the overall building (thermal, electrical, and primary energy), and energy performance for the main systems (thermal, electrical, and primary energy).

(\*\*\*\*) These tests are listed considering the potential of this building to perform them:

-Air leakage: Blower-Door test

-Performance monitoring: KPIs and simulation

-Joint security: Infrared thermography test

-Material check: visual inspection

-Overall system check: TRNSYS simulation

-Other: Moisture detection by means of 3d laser scanning

### 3.2 Storyboards

Demo cases 1 and 2 are correlated with those storyboards already developed for the Ancona's meeting (M24 GA). This is logical since the same storyline could be transversal to several demo-cases, but complementary by offering different possibilities. On the other hand, Demo case 3 requires the development of a specific storyboard.

Demo Case 1: Check and approval of measured values (self-inspection at component level):

- Storyboard 1: Prefab facade system for rooftop extension; step 6a: Prefab made building deviation analysis.

See the sequence about CARTIF-3 building uploaded to *SharePoint*:

*Storyboard1\_Step6a\_Prefab\_Made\_Building\_Dev\_Analysis.zip*:

<https://www.insiter->

[project.org/Shared%20Documents/Forms/AllItems.aspx?RootFolder=%2fShared%20Documents%2f05%20General%20Assembly%2f02%20Meetings%2f06%20Consortium%20meeting%20%28M24%29%2030%20Nov%2d%201%20Dec%2e%202016%20%2d%20Ancona%2c%20IT%2fPresentations&FolderCTID=0x012000C2A304B4D90D9040A6CB656C2EE845CA&View=%7b6E9E3FDF%2d936F%2d48F4%2d9D22%2dA1971DF3C0F1%7d](https://www.insiter-project.org/Shared%20Documents/Forms/AllItems.aspx?RootFolder=%2fShared%20Documents%2f05%20General%20Assembly%2f02%20Meetings%2f06%20Consortium%20meeting%20%28M24%29%2030%20Nov%2d%201%20Dec%2e%202016%20%2d%20Ancona%2c%20IT%2fPresentations&FolderCTID=0x012000C2A304B4D90D9040A6CB656C2EE845CA&View=%7b6E9E3FDF%2d936F%2d48F4%2d9D22%2dA1971DF3C0F1%7d)

The objective is the check of the BIM model against reality. This is done by an analysis of a point cloud laser-measured result.

Demo Case 2: Building envelope quality (self-inspection at building level):

- Storyboard 2: Joints and critical insulations at connection between the original roof and new façade panels; step 12: Measurement of the thermal performance and air tightness.



A sequence of photographs and a video (not professional) about CARTIF-3 building for testing and validation is uploaded into *SharePoint*: see file *Storyboard2\_Step12-2D\_3D\_Thermal\_Performance-CARTIF.zip*:

<https://www.insiter-project.org/Shared%20Documents/Forms/AllItems.aspx?RootFolder=%2fShared%20Documents%2f05%20General%20Assembly%2f02%20Meetings%2f06%20Consortium%20meeting%20%28M24%29%2030%20Nov%2d%201%20Dec%2e%202016%20%2d%20Ancona%2c%20IT%2fPresentations&FolderCTID=0x012000C2A304B4D90D9040A6CB656C2EE845CA&View=%7b6E9E3FDF%2d936F%2d48F4%2d9D22%2dA1971DF3C0F1%7d>

Demo Case 3: Commissioning of the solar thermal system (Self-inspection & Self-instruction):

- Storyboard 3:
  - Verify if the components of the solar system (solar collectors, pumps, plumbing, heat exchanger, thermal storage and controllers) are in accordance with the purchase requirements, then the guidelines for the proper installation of the solar system through VR/AR.
  - Surveillance the performance of the solar thermal system during its life-span taking in to account the specifically related thresholds and KPI.

### 3.3 Demo case selection

Three demo-cases have been selected upon the two use case scenarios (*Figure* and *Figure 16*) pre-established in the project for the CARTIF-3 building.

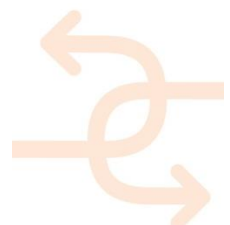

I. Project setting	II. EeB main aspects / inspection fields	III. EeB KPIs and parameters	IV. Scope / focus of inspection	V. Actors involved	VI. Applied techniques and instruments	VII. Used for
<b>Building renovation/maintenance (this use case complements the before one by adding the operational stage)</b>	Building envelope and Indoor Environment Quality	<p>based on Spanish technical standards / norms:</p> <p>Parameters:</p> <ol style="list-style-type: none"> <li>1. Air-tightness N50-value max. 1,5 (pressure 50 Pa)</li> <li>2. U-value</li> <li>3. Total primary energy consumption</li> <li>4. Indoor quality</li> </ol>	<p>prefab building panel:</p> <ol style="list-style-type: none"> <li>1. window /wall joint</li> <li>2. wall/wall joint</li> <li>3. wall/roof joint</li> <li>4. plug socket in wall</li> <li>5. roller shutter casing</li> <li>6. Unsuitable material</li> <li>7. Insulation/wall</li> </ol>	<p>Construction workers (during on-site process)</p> <p>Specialists / technical advisors</p>	<p>method: Blower door test Thermal Camera</p> <p>Hardware: e.g. Minneapolis DG-700 + laptop (+app) Fluke camera</p> <p>Software: e.g. TECTITE Express Fluke SW</p> <p>Data management: cloud solution</p>	CARTIF3 Valladolid, ES (CARTIF)

Figure 15: Initial use case scenario (1) proposed by means of CARTIF-3 building

I. Project setting	II. EeB main aspects / inspection fields	III. EeB KPIs and parameters	IV. Scope / focus of inspection	V. Actors involved	VI. Applied techniques and instruments	VII. Used for
<b>Building maintenance</b>	HVAC systems and Indoor Environment Quality	<p>based on Spanish technical standards / norms:</p> <p>Parameters:</p> <ol style="list-style-type: none"> <li>1. Delivered energy by the component</li> <li>2. Consumed energy by the component</li> <li>3. Efficiency (performance) of the component</li> </ol>	<ol style="list-style-type: none"> <li>1. Under/over-size of the heating/cooling systems</li> <li>2. Underperformance operation</li> </ol>	Energy specialists / technical advisors	<p>method: Inspection technique to be developed under T1.3 by using the WP tools</p> <p>Data management: Sensor network data measurements</p>	CARTIF3 Valladolid, ES (CARTIF)

Figure 16: Initial use case scenario (2) proposed by means of CARTIF-3 building

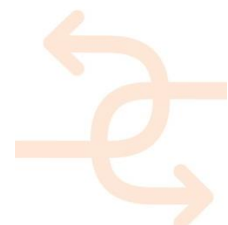

3.3.1 Demo Case 1, check and approval of measured values (self-inspection at component level)

See storyboard:

Storyboard within the Spanish Pilot	Pictures	Involved partners
<p>Prefab made building deviation analysis: This is in parallel to Storyboard 1: Prefab facade system for rooftop extension (step 6a) of the Cologne pilot site.</p> <p>CARTIF-3 demo case is focused on maintenance / refurbishment, adding the operational stage regarding Cologne's case (focused in new construction).</p> <p>3D imaging sensors, such as laser scanners, are being used not only to create CAD/BIM models of the as-is conditions of prefab made buildings, but also for quality assurance comparing the 3D data with the as-is CAD/BIM geometry to identify potential errors in the model (deviation analysis).</p> <p>This method can help identify the sources of errors and does not require additional physical access to the facility.</p>	 	<p>CARTIF, DEMO, HVC, 3L</p>

**Short description:**

3D point clouds and laser scanning derived models (even geolocated) can improve building projects by analysing clashes between newly designed elements and existing conditions or by evaluating the current situation prior to refurbishment. The accurateness of dimensions obtained by laser scanning can also help improve planning by providing exact measurements for insertion and removal of prefab components, minimizing waste and changes in the field.

**Expectation:**

Qualitative (images and 3D representations) and quantitative (numerical statistics) analysis of the geometric deviations between a design (CAD/BIM model) and the point cloud corresponding to the real situation for construction and refurbishment purposes.

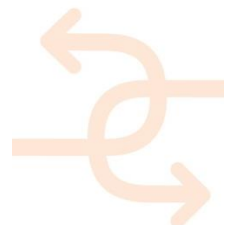

**Threshold:**

According to tolerance requirements.

In order to make a traffic light evaluation (red, yellow and green) two positive tolerance values (positive high: Hi+ and positive low: Lo+) and two negative levels of tolerance (negative high: Hi- and negative low: Lo-) must be fixed. *Figure* shows as an example with numerical values (1 and 2).

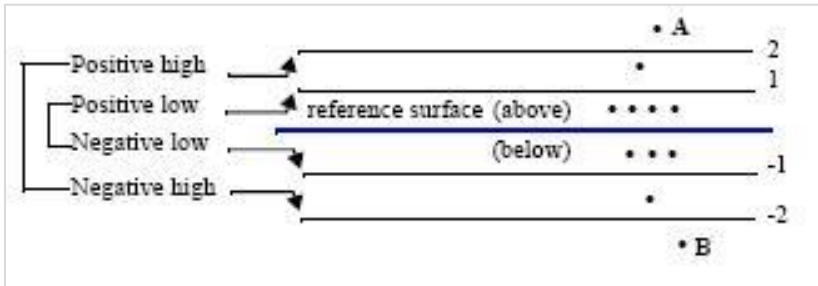

Figure 17: Tolerance range understanding

**Equipment & calibration:**

- 3D laser scanner (time of flight or phase shift technologies).
- Software package for point cloud editing, 3D modelling and dimensional control.
- High-performance computer.

Assuming proper use of the equipment, it is necessary to calibrate the scanner when there is discontinuity in the overlap between angular windows in the data collection. This calibration can only be executed by the manufacturer and implies an accurate adjustment in the mechanical elements that allow the laser scanning over the area to be digitised. This calibration is on demand, there is no specific periodicity.

**INSITER solution:**

The realisation of a 3D laser scanning to demonstrate its feasibility for geometry discrepancies/deviations assessment has already been stated in *D5.1: section 9.2.3: Proof-of-concept following the protocols for geometric discrepancy test with BIM and AR* and *D2.3: section 7.2: Verification on practical effectiveness of the solution*.

1. Laser scanning of representative elements of the envelope of an energy efficient building made of prefab modules (or where prefabricated panels are to be assembled) needs to be performed trying to evade voids.

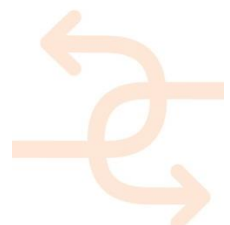



Figure 18: 3D laser scanning of CARTIF-3 as example of energy efficient building made of pre-fab components

2. Once it is verified that the data are complete, the partial point clouds are processed and registered together into *PolyWorks* (or equivalent 3D metrology & modelling sw package: *Figure 19*). It is rather unusual getting a unique point cloud at once on-site.

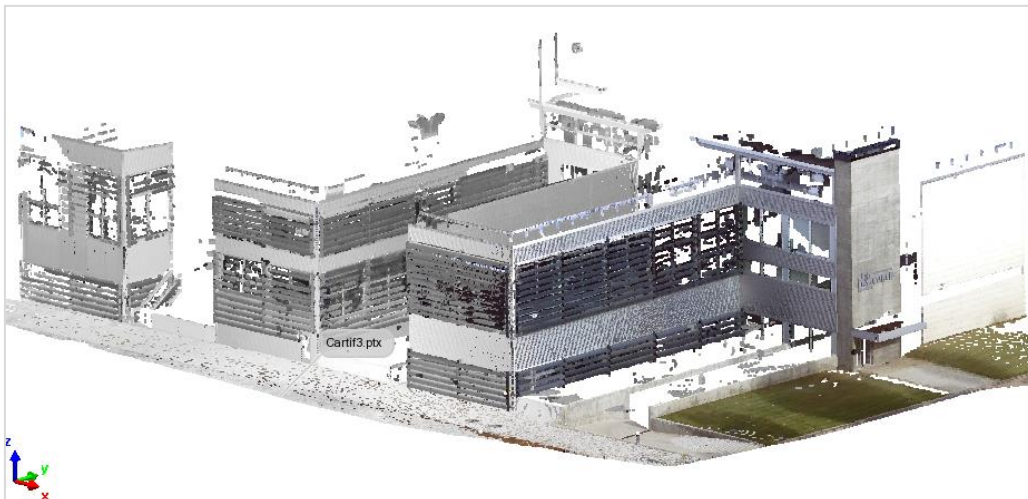
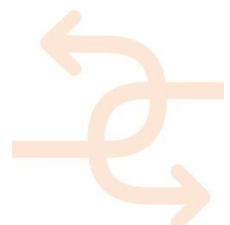

Figure 19: Global point cloud of the interesting area of CARTIF-3

The scanning accuracy is evaluated to verify the appropriateness for the assessment of deviations. As proven in the initial test cases at CARTIF-3 building, measuring deviations below the 2.5 mm are not possible since obtained standard deviation is 1.2 mm by modelled accuracy (plane featuring).

3. A parametric model of the building/part to build-up/refurbish is needed for proper planning (CAD/BIM format). This model is used as reference onto which contrasting the point cloud resulting of the scanning process (*Figure 20*).



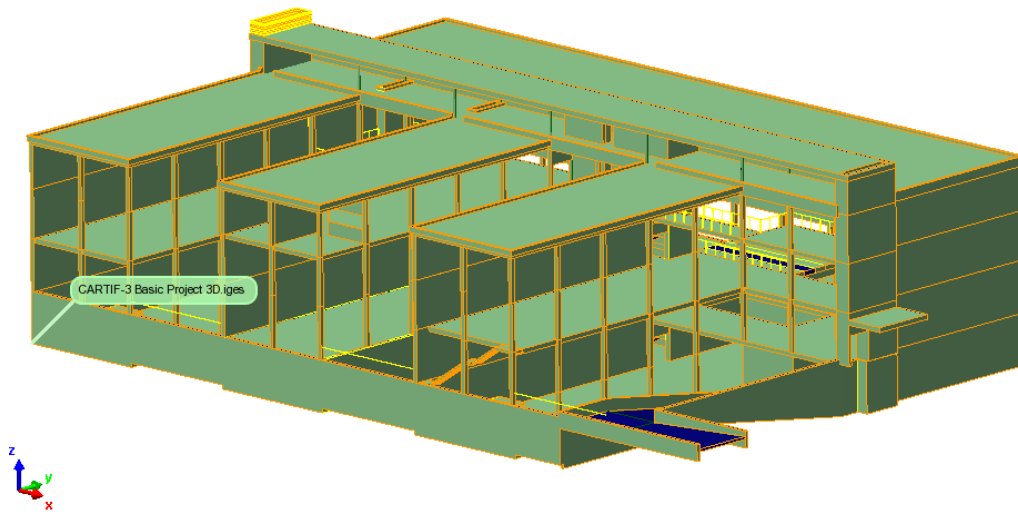

Figure 20: IGES reference model of CARTIF-3

4. The alignment of the reference model and the 3D scanning is carried out in a straightforward way into Polyworks (or eq.). The process can be done upon providing an initial solution by matching pairs of common points between both files, and then automatically applying the so called Iterative Closest Point algorithm (ICP) to iteratively best match the reference (this algorithm or eq. is included in 3D metrology & modelling sw packages).

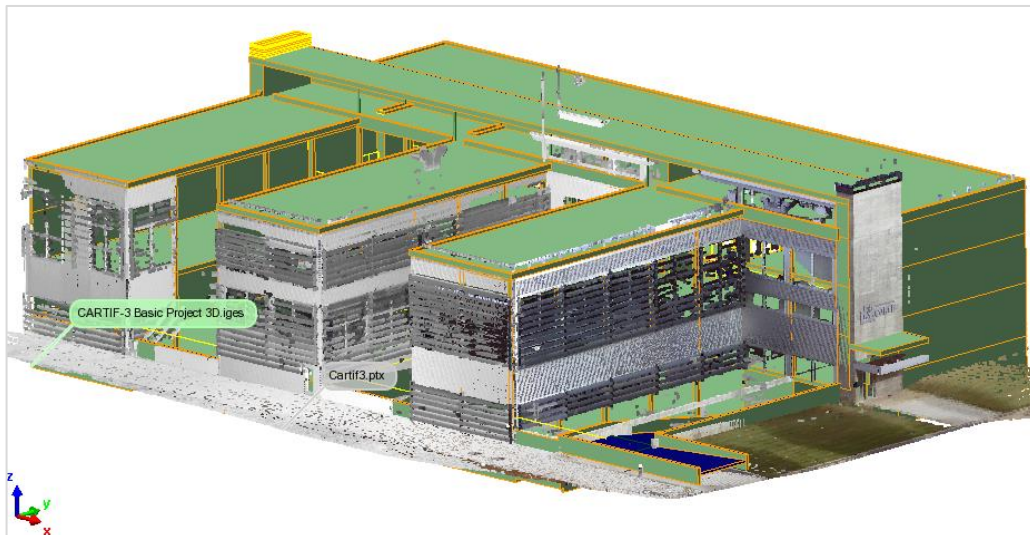
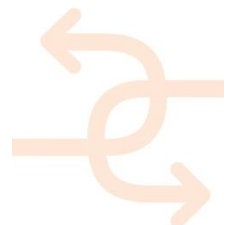

Figure 21: Registration between the data and reference models of CARTIF-3 for the analysis of deviations

Hence the deviations (in the nominal -shortest- direction) are computed by means of the indicated software package between the reference model and the data model (point cloud), which reflects the current status of the building made of prefab components.



- To make the deviations more evident, a range of tolerances according to expert criteria (two positives: Hi+, Lo+ and two negatives: Hi- and Lo-) are set to display a traffic light map (Figure 22).

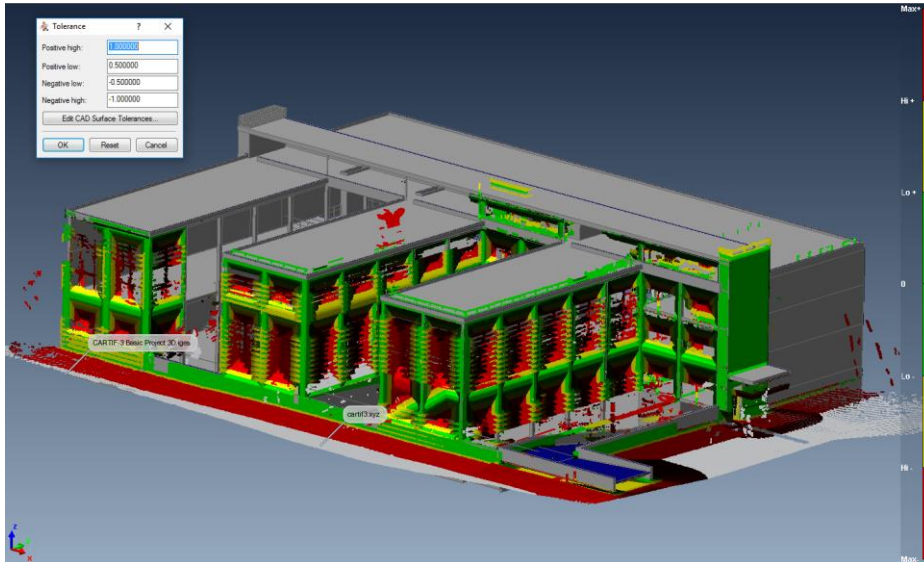

Figure 22: Traffic light deviation map according to tolerances: Hi  $\pm$  1.0m; Lo  $\pm$  0.5m; Lo = -0.5m; Hi = -1.0m.

The blades were not initially planned; consequently the highest deviations are there. This implies a positive (outwards) difference exceeding 40 cm from the original project, which has been verified on-site with a ruler.

**Result:**

According to tolerance values:



**Out of tolerances**



**Admissible:** deviations between Lo+ & Hi+ and between Lo- & Hi- tolerance values



**Adequate:** deviations between Lo- and Lo+ tolerance values

**Follow-up actions:**

Three categories are offered in line with the results:



**Action needed**



**Action possibly needed**



**Continue process**

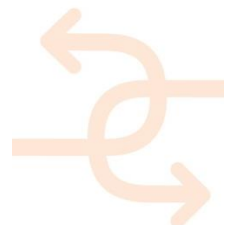



3.3.2 Demo Case 2, building envelope quality (Self-inspection at building level)

See storyboard:

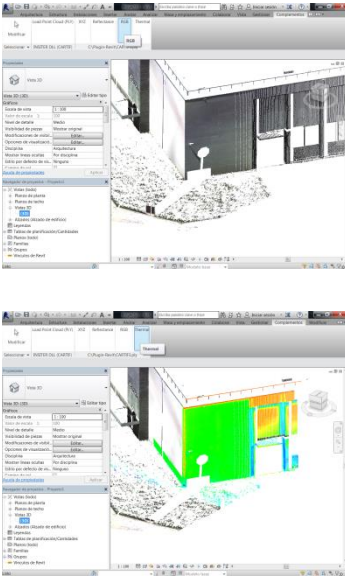
Storyboard within the Spanish Pilot	Pictures	Involved partners
<p>Measurement of the thermal performance and air tightness. This is in parallel to Storyboard 2: Joints and critical insulations at connection between the original roof and new façade panels (step 12) of the Cologne pilot site.</p> <p>CARTIF-3 demo case is focused on maintenance / refurbishment, adding the operational stage regarding Cologne's case (focused in new construction).</p> <p>The process to combine 2D imaging (for example: infrared thermography) with 3D data is described, just making it usable into BIM through a dedicated plug-in called INSITER-DLL (specifically developed for REVIT).</p>		<p>CARTIF, UNIVPM, SIEMENS, DEMO, HVC, 3L (to be confirmed)</p>

**Short description:**

To help the self-inspection procedure, the tailored INSITER-DLL plug-in allows combining 2D & 3D relevant information (geometry, colour, reflectivity, thermography, etc.) to be managed into REVIT as BIM representative tool through PLY point clouds (Figure 23).

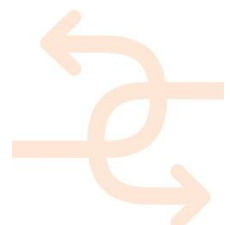

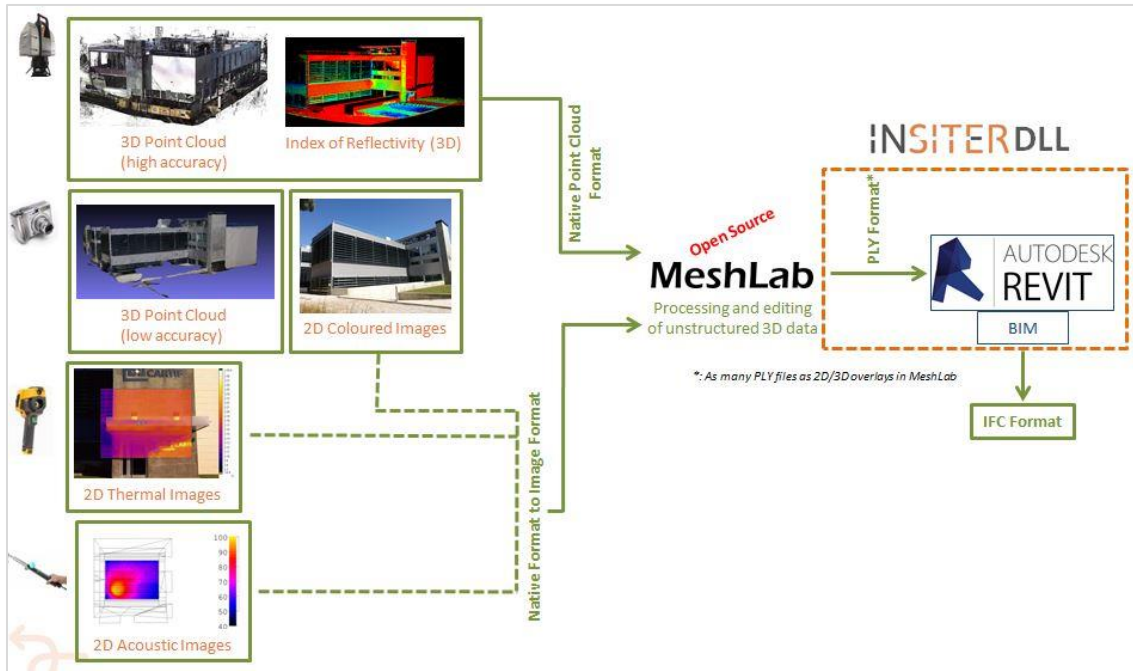

Figure 23: Process of integration of 2D images and 3D data for visualization and use into REVIT through the INSITER-DLL

**Expectation:**

Providing BIM compatible software tools to help in the decision making process on the actions to be carried out upon a building made of prefabricated panels and energetically efficient for renovation / maintenance actions.

The combination of 2D imaging and 3D data cannot be carried out online for self-inspection and self-instruction purposes, but the results it provides could always be used for analysis and verification on-site.

**Threshold:**

Not applicable.

**Equipment & calibration:**

- 3D laser scanner (Time of flight or Phase shift technologies) to get geometrical (dimensional control), colour (appearance control) and reflectivity data (materials & humidity control).
- Thermographic camera (emissivity mapping).
- Software package for point cloud editing, 3D modelling and dimensional control.
- MeshLab open source software (mainly for 2D/3D overlapping).
- REVIT license.
- High-performance computer.

The thermal imaging camera have to calibrate each image acquisition according to the type of material and the environmental conditions to relate the emissivity readings with specific temperatures for proper detection of thermal



bridges. Additionally, the thermal imaging camera needs periodical calibration (hardware) according to the specifications of each brand or trademark and model.

The 3D laser scanner has to be calibrated when there is discontinuity in the overlap between angular windows in the data collection. This calibration can only be executed by the manufacturer and implies an accurate adjustment in the mechanical elements that allow the laser scanning over the area to be digitised. This calibration is on demand, there is no specific periodicity.

**INSITER solution:**

The INSITER-DLL installation and use description is given in the sections 8.1 and 8.3.1 of the deliverable *D2.3: Toolset of capturing, measurement and diagnostic systems for self-inspection*.

The INSITER-DLL is continuously improved, including the current adaptation to the 2017 version of REVIT. Therefore, interested partners should request it to CARTIF on demand to be provided with the appropriate version for trials.

**Result:**

According to the derived analysis (in REVIT):



**Out of tolerances**



**Admissible:** deviations between Lo+ & Hi+ and between Lo- & Hi- tolerance values



**Adequate:** deviations between Lo- and Lo+ tolerance values

**Follow-up actions:**

Three categories are offered in line with the results:



**Action needed**



**Action possibly needed**



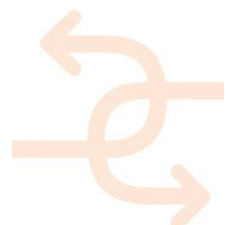

**Continue process**

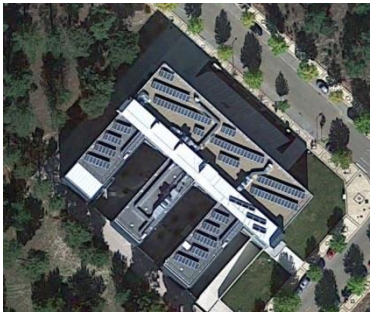

3.3.3 Demo Case 3, commissioning of the solar thermal system (Self-inspection & Self-instruction)

See storyboard No.3:

Storyboard within the Spanish Pilot	Pictures	Involved partners
<p>Two aspects need to be gathered regarding solar thermal systems installed in energy-efficient buildings made from prefabricated panels:</p> <ul style="list-style-type: none"> <li>• Verify if the components of the solar system (solar collectors, pumps, plumbing, heat exchanger, thermal storage and controllers) are in accordance with the purchase requirements, then the guidelines for the proper installation of the solar system through VR/AR.</li> <li>• Surveillance the performance of the solar thermal system during its life-span taking in to account the specifically related thresholds and KPI.</li> </ul>	 	<p>CARTIF, UNIVPM, SIEMENS, FRA-IPA, DEMO, RDF, 3L</p>

**Short description:**

During the lifespan of the solar thermal systems there are faults, underperformance, wrong operation conditions, and unexpected shutdowns of the installation. Thus, the target of this storyboard it is to avoid as much as possible those problems and try to improve the installation performance in relation to the foreseen quality.

**Expectation:**

Surveillance the right operation of the solar thermal system takes into account the KPI's and the design parameter to achieve the best performance of the system and increase the useful thermal energy.

**Threshold:**

The O&M department would be responsible of the threshold definition for the main components.

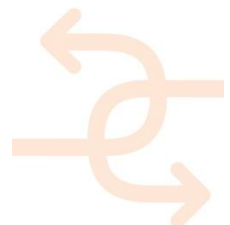

***Equipment & calibration:***

These devices are needed:

- Flow meters
- Data loggers
- Heat meters
- Weather station
- Thermographic camera
- QR/Bar code scanner

The calibration will be defined according to the specifications of each equipment and standards.

***INSITER solution:***

The storyboard begins when equipment is received at the facility. The aim of is **verifying** and checking of items according to invoice requested.

1. Using a bar code /QR scanner, people responsible for received equipment (solar collectors, heat exchangers, hydraulic elements, circulation pumps, accumulation tanks), should verify that the delivery is correct and check several points such as: references, quantity, specification and visual inspection (glass, insulation, casing, etc.). All information should be gathered in INSITER database.
2. The installation process by self-instruction support will be defined. 2D imaging will be used as support for the O&M team; they will have available 2D/3D installation schemes to allow the proper assembly of each element step by step. The tool will notify them through checks list not only the step that should be followed but its estimated time. The self-instruction will be defined for each one of the main elements (collectors, heat exchangers, circulation pumps, accumulation tanks, expansion vessels, control).
3. Filling the installation, it should be filled with the glycol/water mixture, the installer checks the concentration of the mixture which will depend of the geographical area, and then they would check the pressure of the system, antifreeze protection.
4. Check the electrical installation requirements (power of appliances, protections, connections, electrical supply) in accordance with the electrical schemes available in the INSITER tool.
5. Through the use of thermographs, it will be tested if the installation has problems of insulation, humidity, besides a visual inspection after the installation activities has been finished.

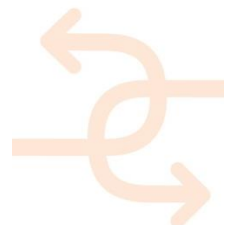

**Result:**

According to invoiced (INSITER solution step 1):



Rejected



Accepted and continue with the installation

According to INSITER proposed solution (steps 2 to step 5):



No correct installation



Installation in progress



Accepted and continue process

The last step of the storyboard is the monitoring and continuous commissioning of the installation during the lifetime. These **surveillance** tools avoid both the underperformance and correct operation of the solar thermal system.

By means of the monitoring available in the INSITER tool, the indicators for each of the main elements of the solar thermal system defined in the deliverable D1.6 will be implemented; those indicators will report in real time if the installation is operating within the right range or if any intervention is necessary. The following tables (*Table 33*, *Table 44*) show the indicators for each of the components.

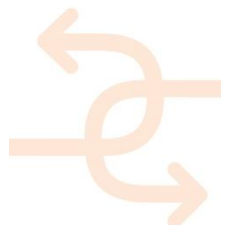

Solar Thermal System				
Indicator	Equation	Rule	Fault aim	Fault
Primary Flow	$\frac{\dot{m}_{measured}}{\dot{m}_{set}} = \dot{m}_{prim}$	$0,95 < \dot{m}_{prim} < 1,05$	Detect normal operation of pump	Primary pump out of nominal conditions
Secondary Flow	$\frac{\dot{m}_{measured}}{\dot{m}_{set}} = \dot{m}_{sec}$	$0,95 < \dot{m}_{sec} < 1,05$	Detect normal operation of pump	Second pump out of nominal conditions
Heat Exchanger	$\frac{\eta_{measured}}{\eta_{nominal}} = \eta$	$0,85 < \eta < 1$	Detect abnormal operation of solar system	Outperformance of solar system
Temperature of the collector fields		$T_{coll} < T_{coll,h}$	Protection of solar system	Stagnation risk

Table 2: Solar thermal system KPI's

Pumping modules				
Indicator	Equation	Rule	Fault aim	Fault
Flow	$\frac{\dot{m}_{measured}}{\dot{m}_{set}} = \dot{m}$	$0,7 < \dot{m} < 1,3$	Detect pump operation outside nominal regime	Pump error
Electric Power	$\frac{W_{measured}}{W_{foreseen}} = W$	$W > 1,25$	Fault in facilities after 30 sec. from start	Extra energy consumption
Temperature, Temp. ref.		$ T_x - T_{x,ref}  < \varepsilon_x, persistent$	Detect possible problem with valve. Detect possible problem with PID parameters, or with IO&C board	Wrong supply temperature

Table 3: Solar thermal pumping system KPI's

Storage system			
Indicator	Rule	Fault aim	Fault
Temperature	$T_{storage} < 50^{\circ}C$	Detect abnormal operation	Storage temperature too low
Temperature	$T_{storage} > 90^{\circ}C$	Detect storage overheating	Storage temperature too high
Temperature, Temp. ref.	$ T_x - T_{x,ref}  < \varepsilon_x, persistent$	Wrong supply temperature	Possible problem with valve. Possible problem with feedback PID parameters, possible problem with IO&C board

Table 4: Solar thermal storage system KPIs

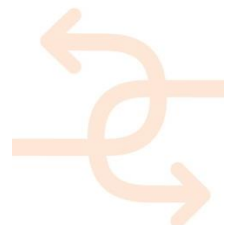

**Results:**

As outcomes of the surveillance of the performances of the solar thermal systems, three levels of quality will be identified and classified depending on priority.



**Follow-up actions:**

Three categories are offered in line with the global results (verifying components and surveillance the performance of the solar thermal system):

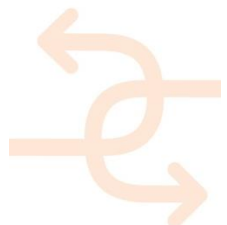



## 4. Concetto Marchesi, IT

### 4.1 Site characteristics and description

The Concetto Marchesi is a modular school building from 1974 with a modular construction grid, a precast structure and made of prefab components. The building is in poor maintenance condition and therefore deep renovation processes will be performed. Field demonstration activities will focus on geometrical consistency, testing of thermal bridges and checking of the connections between existing building and additions.

The school complex is located in a suburban area called Pisanova, located on the Eastern side of the town of Pisa, central Italy. The area is crossed by an important road axis that connects with the historic city to the West and with the highway and freeway to the East. The building is located in an irregular-shaped site, bordered on the North and East from Enrico Betti Street (beyond which there is a public green area) and Concetto Marchesi Avenue, while on West and South sides is surrounded by some residential buildings. The ground is flat and the entire area is considered of medium risk for flood from Arno river, therefore there are some specific construction requirements due to safety reasons.

On the East portion of the area, there is a huge sporting field with athletics track, directly connected to the school complex. The school complex has a swimming pool which is also accessible by the general public.

There is a parking area just next to the building, which can be used by school personnel, students and visitors. The district is connected to the city centre, to the railway station and to some important university centres by several public transport lines. The area is also accessible by private vehicles without any restrictions. The urban context is of recent construction and is made up of extremely heterogeneous buildings, in the architectural aspects as well as in the different building types: for instance, there are multi-story residential complexes, one-story commercial facilities and 8-story office buildings that coexist with some former agricultural buildings.



Figure 24: location of Concetto Marchesi in Pisa

The school complex project did not look for a synthesis with the context but still arises as an autonomous urban element.

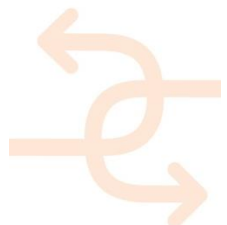

At the same time, the intention of the project was originally to provide a large square and a public space for the entire area. For this reason, the roof was accessible both from the students, since lessons could take place over there, and from inhabitants of the neighbourhood. In this sense, the building was very innovative and strictly related to the urban context. The school complex has a prefabricated concrete structure with pillars, beams and panels and consists of four different building portions, which house two different high schools, the shared areas and some other additional activities (canteen, swimming pool, two gyms, a large auditorium etc.). Those portions are characterized by strongly articulated volumes developed on two, three and four floors above ground. The roof is a broad, slightly sloping surface, which was originally completely workable. The steep pitch of the central core of the building, that hosts the shared facilities, stands out for the walkable roof surface. This nucleus is therefore the main element of the entire facility: it is accessible by two courtyards, defined by a system of simple or giant pillars (round-shaped and with massive shelves on the top), to support the roof and the school and the office spaces. In these courtyards there is the access to the two high schools and the vertical connections for the offices. The entire building is approximately 14,612 m<sup>2</sup> and 43,836 m<sup>3</sup>, for a total amount of approx. 1,675 students. The facility has been subjected to several maintenance works during the past decades, and has presented increasingly frequent criticisms, so that in 2017 it was decided to demolish the building and rebuild it, maintaining only the abovementioned nucleus (devoted to swimming pool, gyms and canteen), due to the excessive costs imposed by the continuous work of maintenance.

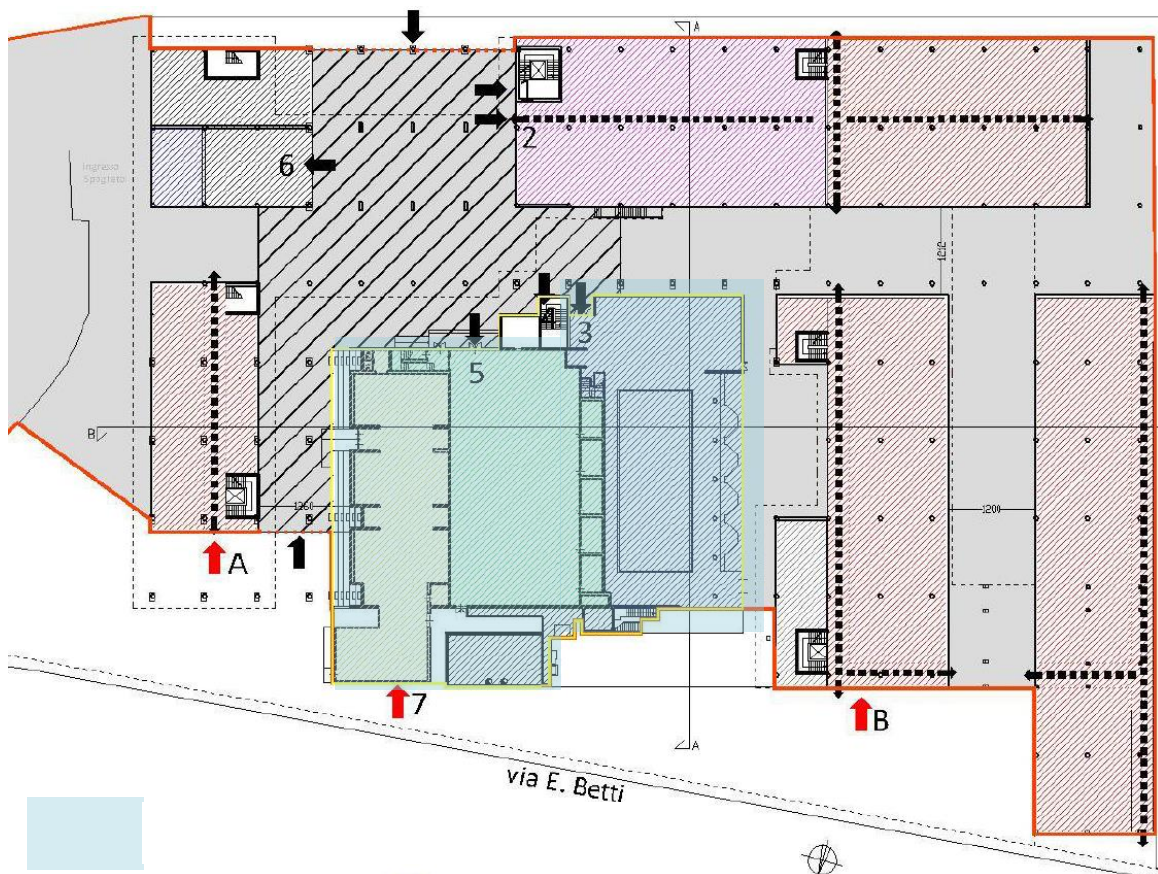
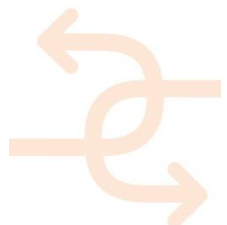

Figure 25: future condition, ground floor plan



Project name and location:

- Name: School complex Concetto Marchesi.
- Location: Pisa, Italy.

Short description:

- Characteristics:
  - School complex within a residential neighbourhood on the West side and non-residential district on the East side
  - Detached building on medium size area.
  - Used.
- Size: 14,612 m<sup>2</sup>.
- Volume: 43,836 m<sup>3</sup>.
- Construction and utility systems, main building materials:
  - Concrete basement.
  - Prefab structure and prefab panels for the envelope.
  - Aluminium windows.
  - Main construction (concrete) suitable for re-use
  - Utility systems (MEP) are obsolete
  - Building façade is old and energetically outdated
- Current maintenance state: poor.
- Maintenance and deep renovation plan:
  - No change of use
  - No change of occupancy level
  - School activities + social/community services

Project owners and stakeholders:

- Province of Pisa
- Stakeholders:
  - High school principal
  - Students
  - Citizens



(Remark: The purpose of the inventory list is to gain general information from the demonstrators with regard to their qualification for testing needs. Further data are stored on the share point.)



WP5 inventory list

no	1																																																			
name	School Complex "Concetto Marchesi", Pisa																																																			
country	Italy																																																			
year of completion	1975																																																			
volume m <sup>3</sup>	85.000																																																			
number of storeys	4																																																			
new/existing	retrofit																																																			
use	educational																																																			
		<table border="1"> <thead> <tr> <th colspan="5">available data</th> </tr> <tr> <th>2D analog</th> <th>2D digital</th> <th>3D digital</th> <th>BIM</th> <th>other</th> </tr> </thead> <tbody> <tr> <td><input checked="" type="checkbox"/></td> <td><input checked="" type="checkbox"/></td> <td><input type="checkbox"/></td> <td><input type="checkbox"/></td> <td><input type="checkbox"/></td> </tr> <tr> <td><input checked="" type="checkbox"/></td> <td><input checked="" type="checkbox"/></td> <td><input type="checkbox"/></td> <td><input type="checkbox"/></td> <td><input type="checkbox"/></td> </tr> <tr> <td><input checked="" type="checkbox"/></td> <td><input checked="" type="checkbox"/></td> <td><input type="checkbox"/></td> <td><input type="checkbox"/></td> <td><input type="checkbox"/></td> </tr> <tr> <td><input type="checkbox"/></td> <td><input type="checkbox"/></td> <td><input type="checkbox"/></td> <td><input type="checkbox"/></td> <td><input type="checkbox"/></td> </tr> <tr> <td><input type="checkbox"/></td> <td><input type="checkbox"/></td> <td><input type="checkbox"/></td> <td><input type="checkbox"/></td> <td><input type="checkbox"/></td> </tr> <tr> <td><input type="checkbox"/></td> <td><input type="checkbox"/></td> <td><input type="checkbox"/></td> <td><input type="checkbox"/></td> <td><input type="checkbox"/></td> </tr> <tr> <td><input type="checkbox"/></td> <td><input type="checkbox"/></td> <td><input type="checkbox"/></td> <td><input type="checkbox"/></td> <td><input type="checkbox"/></td> </tr> <tr> <td><input type="checkbox"/></td> <td><input type="checkbox"/></td> <td><input type="checkbox"/></td> <td><input type="checkbox"/></td> <td><input type="checkbox"/></td> </tr> </tbody> </table>	available data					2D analog	2D digital	3D digital	BIM	other	<input checked="" type="checkbox"/>	<input checked="" type="checkbox"/>	<input type="checkbox"/>	<input type="checkbox"/>	<input type="checkbox"/>	<input checked="" type="checkbox"/>	<input checked="" type="checkbox"/>	<input type="checkbox"/>	<input type="checkbox"/>	<input type="checkbox"/>	<input checked="" type="checkbox"/>	<input checked="" type="checkbox"/>	<input type="checkbox"/>	<input type="checkbox"/>	<input type="checkbox"/>	<input type="checkbox"/>	<input type="checkbox"/>	<input type="checkbox"/>	<input type="checkbox"/>	<input type="checkbox"/>	<input type="checkbox"/>	<input type="checkbox"/>	<input type="checkbox"/>	<input type="checkbox"/>	<input type="checkbox"/>	<input type="checkbox"/>	<input type="checkbox"/>	<input type="checkbox"/>	<input type="checkbox"/>	<input type="checkbox"/>	<input type="checkbox"/>	<input type="checkbox"/>	<input type="checkbox"/>	<input type="checkbox"/>	<input type="checkbox"/>	<input type="checkbox"/>	<input type="checkbox"/>	<input type="checkbox"/>	<input type="checkbox"/>	<input type="checkbox"/>
available data																																																				
2D analog	2D digital	3D digital	BIM	other																																																
<input checked="" type="checkbox"/>	<input checked="" type="checkbox"/>	<input type="checkbox"/>	<input type="checkbox"/>	<input type="checkbox"/>																																																
<input checked="" type="checkbox"/>	<input checked="" type="checkbox"/>	<input type="checkbox"/>	<input type="checkbox"/>	<input type="checkbox"/>																																																
<input checked="" type="checkbox"/>	<input checked="" type="checkbox"/>	<input type="checkbox"/>	<input type="checkbox"/>	<input type="checkbox"/>																																																
<input type="checkbox"/>	<input type="checkbox"/>	<input type="checkbox"/>	<input type="checkbox"/>	<input type="checkbox"/>																																																
<input type="checkbox"/>	<input type="checkbox"/>	<input type="checkbox"/>	<input type="checkbox"/>	<input type="checkbox"/>																																																
<input type="checkbox"/>	<input type="checkbox"/>	<input type="checkbox"/>	<input type="checkbox"/>	<input type="checkbox"/>																																																
<input type="checkbox"/>	<input type="checkbox"/>	<input type="checkbox"/>	<input type="checkbox"/>	<input type="checkbox"/>																																																
<input type="checkbox"/>	<input type="checkbox"/>	<input type="checkbox"/>	<input type="checkbox"/>	<input type="checkbox"/>																																																
construction exterior walls	input	concrete																																																		
window frame material	from	aluminium																																																		
door frame	T1.2	aluminium																																																		
	input	drinking water																																																		
	from	heating water																																																		
	T1.3	ventilation																																																		
		electric cable																																																		
		light switch																																																		
		plug socket																																																		
test applicability		air leakage																																																		
		performance monitoring																																																		
		joint security																																																		
		material check																																																		
		overall system check																																																		
		other (please comment)																																																		
test applicability construction phase		laboratory																																																		
		factory																																																		
		on site																																																		
		maintenance																																																		
special requirements regarding site logistics		no																																																		
time schedule		available (provide format)																																																		
		e.g. xlsx																																																		
<p>ORIGINAL PROJECT (1974 + Additions) Architect Luigi Pellegrin. Precast structure + prefab components (opaque/transparent envelope). Module: 1,80 m. Structural grid 7,20 x 10,80 m (Benini System).</p>																																																				

Figure 26: Inventory list

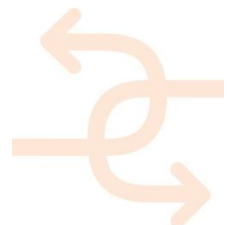



Figure 27: View of the east side



Figure 28: Partial rear view of the east side

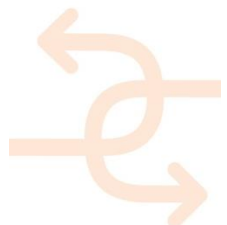
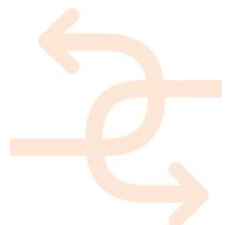



Figure 29: Detail of east side



Figure 30: Relief of structural elements



## 4.2 Storyboards and demo case selection

### Demo case 1: Building envelope – Inspection of deviations in façade panels and windows:

- The consistency of the available 2d drawings has been verified through a laser scanning geometric survey of a portion of the building.
- 3D models test deviation analysis have been performed to compare laser scanning 26 point clouds with created BIM models, via “Scan to BIM” (J. Derrick Braun, HVC, in “D5.2- Lab test report and recommendations”, 2016).
- Alignment of the coordinates of the 3D model with the point cloud reference.
- Inaccuracies and defects identification through ReCap format.

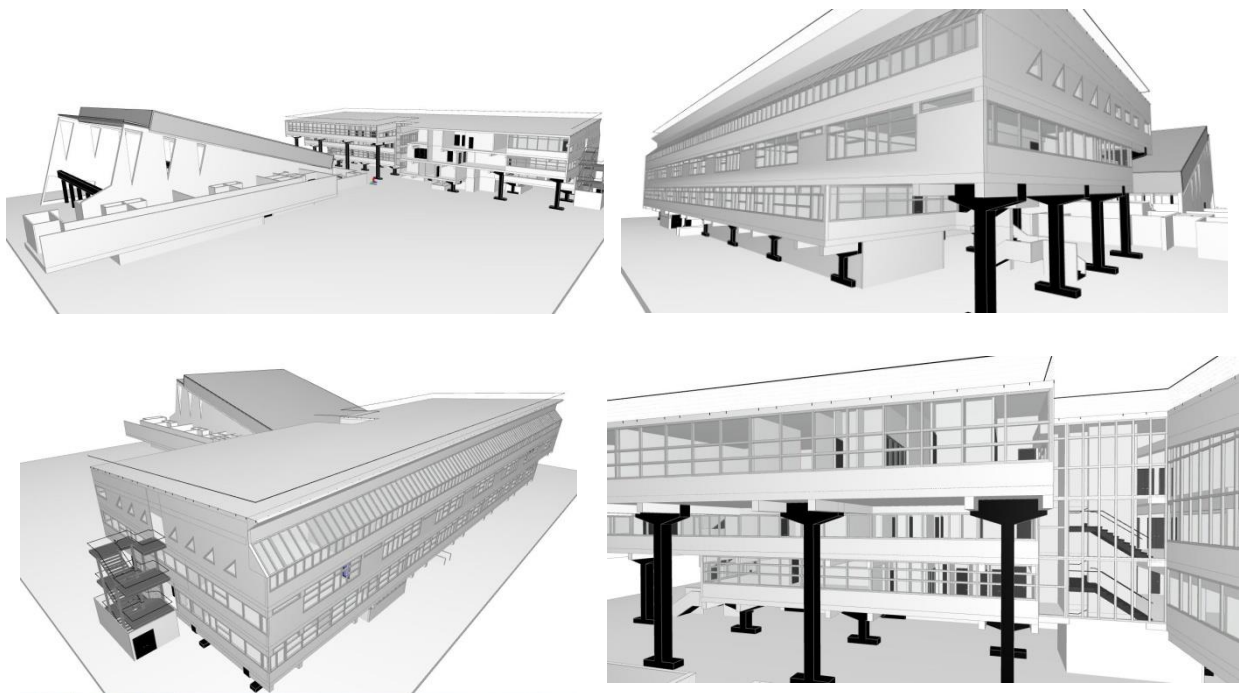

Figure 31: 3D model images

### Demo case 2: Building envelope – Inspection by infrared camera:

- Thermal measurement at critical joints in the façade system.
- Identification of gaps, thermal bridges.

The surveys have been performed using a FLIR B60 camera, capable of capturing the energy emitted by hot bodies ( $-20^{\circ}\text{C} < T < 120^{\circ}\text{C}$ ) in the form of electromagnetic radiation of the band "infrared" / LW (long wave) and turn it into thermographic image and has the following features:

Temperature range:  $-20^{\circ}\text{C}$  to  $120^{\circ}\text{C}$ )  
Temperature accuracy:  $\pm 2^{\circ}\text{C}$  or  $\pm 2\%$  of reading

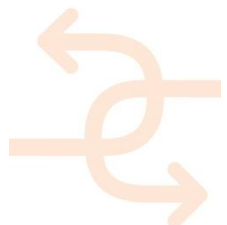

Image Storage:	(1GB micro SD card) 1000 Images
Emissivity Table:	0.1 to 1.0 (adjustable)
Field of view/min focus distance:	25° X 25°/0.10m (3.9")
Thermal sensitivity (N.E.T.D):	<0.08°C at 25°C
Spectral range:	7.5 to 13µm
Detector Type - Focal plane array:	32,400 pixels (180 x 180)
(FPA) uncooled microbolometer	

The analysis has been conducted in the passive voice, i.e. using the direct solar radiation incident on surfaces and natural convective flows.

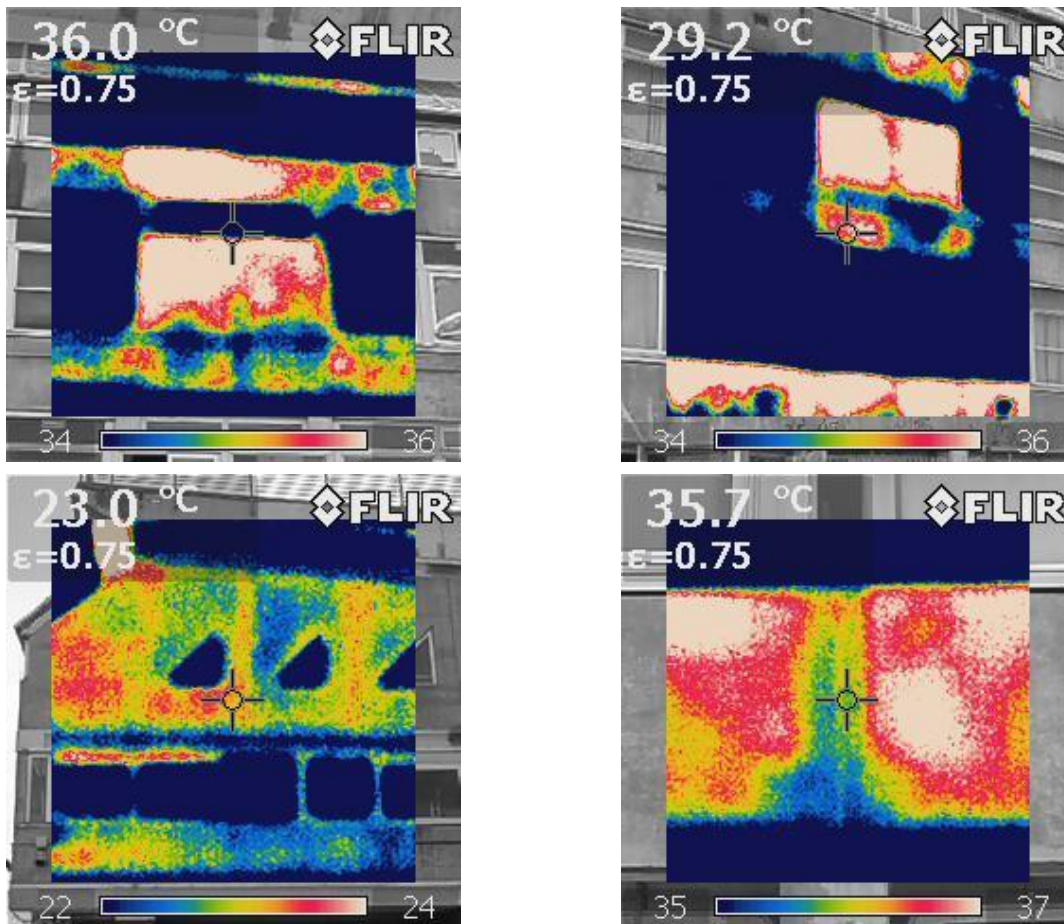

Figure 32: thermal camera images performed on the envelope of the school complex

### Demo case 3: Building envelope post-refurbishment building inspection

- Configuring the software for condition assessment after refurbishment, especially in the connection between the maintained building and the new building additions; embedding the “as-built” BIM model into the inspection software tool.
- Verifying the “as-built” BIM model by updating BIM with inspection data after refurbishment.
- Verifying joints and connections based on the “as-built” BIM model after refurbishment.

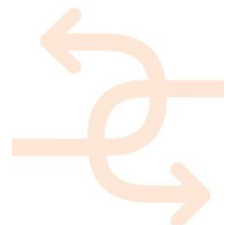
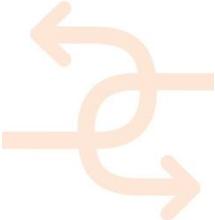





Figure 33: courtesy of [www.bdcnetwork.com](http://www.bdcnetwork.com)



## 5. Hogekamp Enschede, NL

### 5.1 Site characteristics and description

The name of the project is Hogekamp Enschede. It is a building located in Enschede in the eastern part of the Netherlands. The university building is being transformed to a student hostel. It is an abandoned building on the University of Twente campus, originally designed as a university building for teaching and research. The building will be deep renovated into a student hostel and hotel. This case study is a synergy with P2ENDURE project ([www.p2endure-project.eu](http://www.p2endure-project.eu)) coordinated also by DEMO (Dr. Rizal Sebastian). The BIM model is already developed as a part of P2ENDURE project and will be shared with the INSITER. In other words, the BIM model will be taken over and used for the purpose of testing the INSITER methodology. During the renovation of the building - with the agreement from the building owner, project developer and contractor - we will organise the INSITER field testing.

It is a building of approximately 25.000 m<sup>2</sup>, having a basement and 9 floors. It is an empty university education building which is not in use for over 5 years. The building has concrete basement and main construction consists of rib floor and steel windows and it is polluted with asbestos (high risk and amounts). The maintenance state is very bad. A building currently has an Energy label G with the aim to transition into energy label B (target A). Current energy consumption is unknown since building isn't in use for 5 years. The building is located within the University campus environment and there is no traffic or industrial noise. It is a solitary building on a medium size land plot.

Main construction (concrete) is suitable for re-use, while the installation reached end of lifetime. The façades are old and energetically outdated. According to the planning, deep renovation / transformation will start in April 2017 and should be completed in 10 July 2018. Renovation (product implementation) is scheduled to start on 17 June 2017.

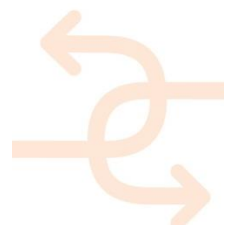

Project name and location:

- Name: Hogekamp Enschede.
- Location: Campus of the University of Twente, Enschede, the Netherlands.

Short description:

- Characteristics:
  - University campus environment – no traffic or industrial noise
  - Solitary building on medium size land plot
  - Empty university educational building, not in use in the past 5 years.
- Size: 25.000 m<sup>2</sup> (9 floors and 1basement floor)
- Construction and utility systems, main building materials:
  - Concrete basement and rib floor plates, steel windows
  - Main construction (concrete) suitable for re-use
  - Polluted with asbestos (high risk and amount)
  - Utility systems (MEP) has reached the end of lifetime
  - Building façade is old and energetically outdated
- Current maintenance state: poor
- Current energy label: G
- Deep renovation / transformation plan:
  - 445 student studio apartments
  - 60 apartments
  - 900m<sup>2</sup> conference and meeting rooms
  - a hotel with 79 guest rooms
- Website: <http://nl.cameloteurope.com/ontwikkeling/ut-enschede>

Project owners and stakeholders:

- Camelot Europe is 75% owner of the building, and thereby the decision maker for the 'student living concept'.
- University of Twente is 25% owner of the building, and thereby the decision maker for the 'hotel and conference concept'.
- Main contact person: Mr. Olaf Terpstra (Manager of Camelot Real Estate)
- Stakeholders:
  - Camelot Property Management (property management of 'student living')
  - University of Twente (owner of hotel)
  - Van Wijnen (building contractor)
  - Hotel Drienerburgt (operator of hotel)
- BIM for research: TU Berlin (Prof. Timo Hartmann)

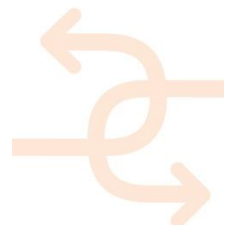

Pictures and drawings

*(property of Camelot Real Estate, not to be published without prior permission)*



*Figure 34: Original building at first opening in 1965 (51 years ago)*



*Figure 35: Picture of the existing building (2016)*

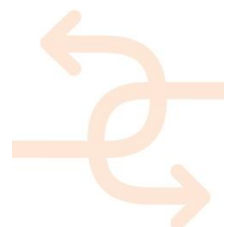

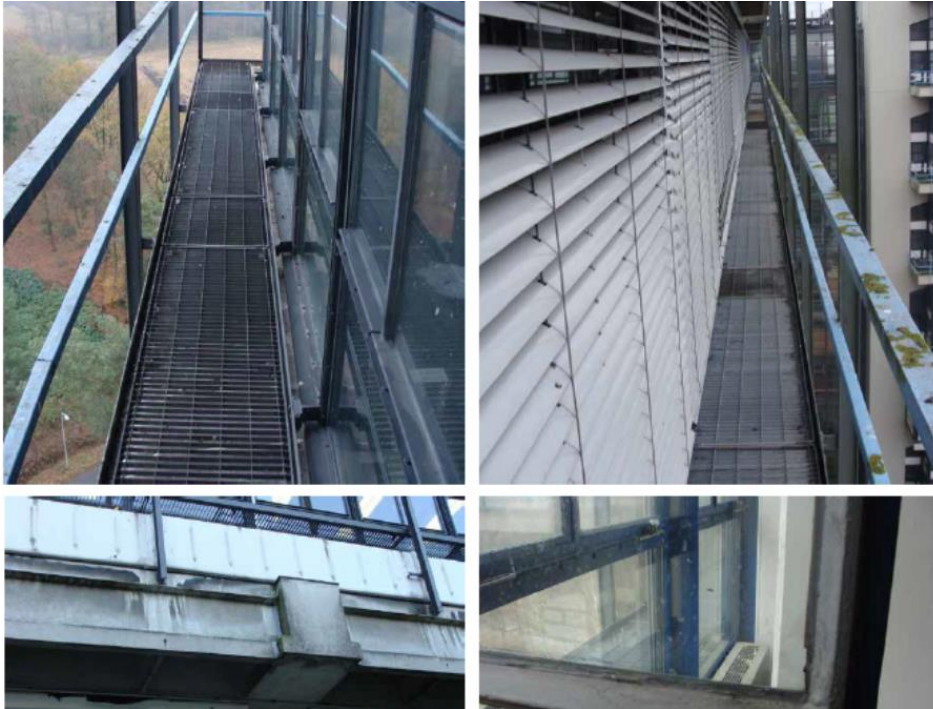
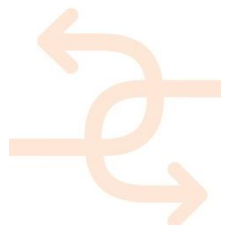

Figure 36: Picture of the existing building (2016)



Figure 37: Picture of the existing building (2016)



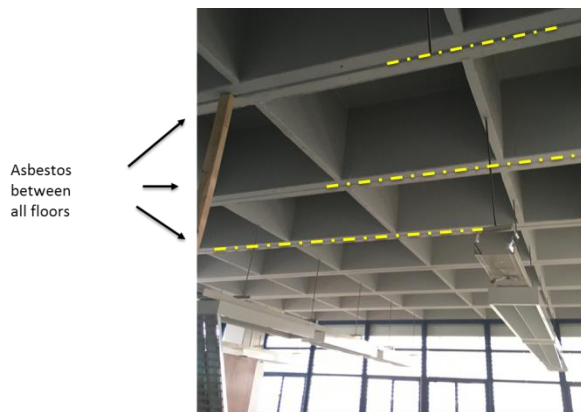

Figure 38: Picture of the existing building (2016)

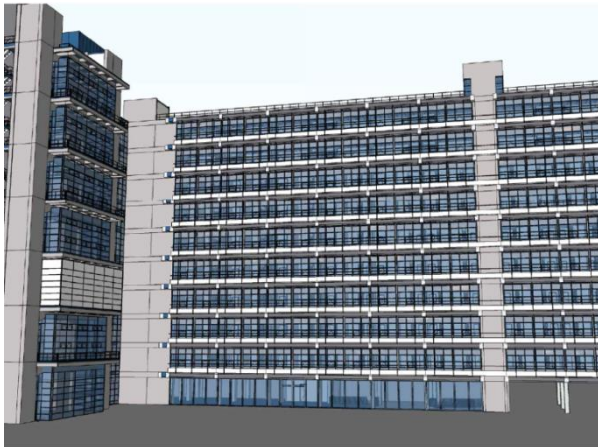

Figure 39: 3D BIM model of the new situation (after deep renovation / transformation)

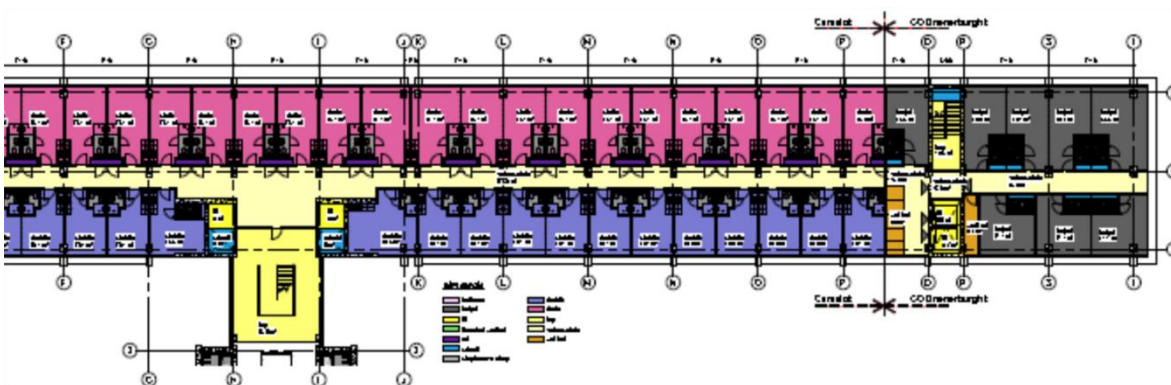
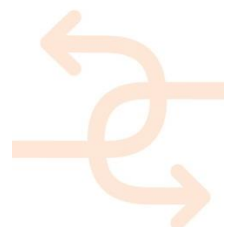

Figure 40: Floor plan of the new situation (after deep renovation / transformation)



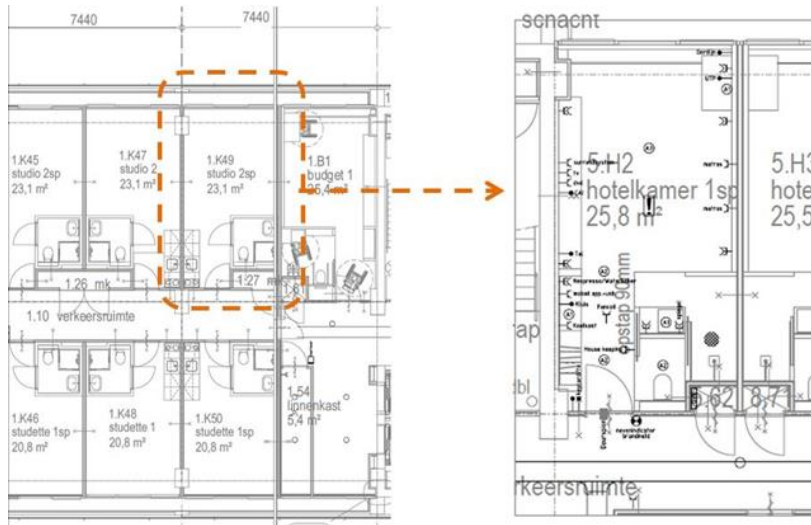

Figure 41: Detailed floor plan of the standard apartment

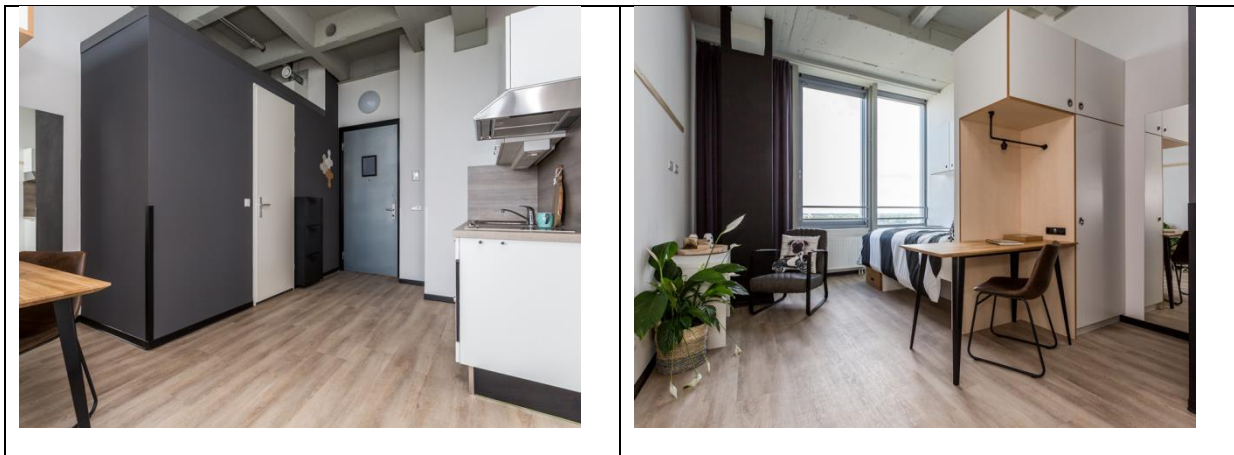
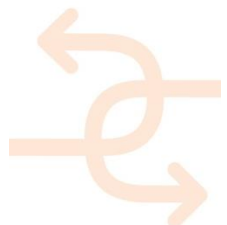
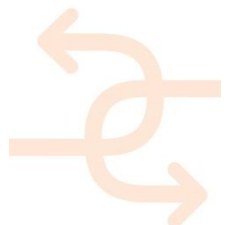

Figure 42: Mock-up of the typical apartment



Project duration	Sept 16	Oct 16	Nov 16	Dec 16	Jan 17	Feb 17	March 17	Apr 17	May 17	June 17	July 17	Aug 17	Sept 17	Oct 17	Nov 17	Dec 17	Jan 18	Feb 18	March 18	Apr 18	May 18	June 18	July 18	Aug 18	
1. Condition assessment: 3D scanning / survey of existing building for obtaining a BIM model	█																								
2. Development of BIM model		█	█	█	█																				
3. Monitoring before renovation (considered only for not vacant buildings, if needed)																									
4. Building permit design		█	█	█	█																				
5. Building permit																									
6. Client's decision about selection of P2ENDURE components				█	█																				
7. Programme of requirements for renovation		█	█	█	█	█	█	█																	
8. Detail design of P2ENDURE renovation																									
9. Detailed specification for P2ENDURE solutions (quantities and dimensions for production)																									
10. Production of components																									
11. On-site preparation																									
12. Renovation/ products implementation																									
13. Commissioning																									
14. Post-intervention monitoring																									

Figure 43: Outlined tentative project planning





WP5 demonstrator inventory list

(Remark: The purpose of the inventory list is to gain general information from the demonstrators with regard to their qualification for testing needs. Further data are stored on the share point.)

INSITER INTUITIVE SELF-INSPECTION TECHNIQUES													
WP5 inventory list													
no			5										
name			Transformation university >> apartments + hotel										
country			The Netherlands										
year of completion			2018										
floor area m2			25,000										
number of storeys			9 floors + 1 basement										
new/existing			refurbishment										
use			other										
				available data									
				2D analog		2D digital		3D digital		BIM		other	
construction exterior walls	input	concrete		<input checked="" type="checkbox"/>	<input checked="" type="checkbox"/>	<input checked="" type="checkbox"/>	<input checked="" type="checkbox"/>	<input checked="" type="checkbox"/>	<input checked="" type="checkbox"/>	<input checked="" type="checkbox"/>	<input checked="" type="checkbox"/>	<input checked="" type="checkbox"/>	<input checked="" type="checkbox"/>
window frame material	from	other		<input checked="" type="checkbox"/>	<input checked="" type="checkbox"/>	<input checked="" type="checkbox"/>	<input checked="" type="checkbox"/>	<input checked="" type="checkbox"/>	<input checked="" type="checkbox"/>	<input checked="" type="checkbox"/>	<input checked="" type="checkbox"/>	<input checked="" type="checkbox"/>	<input checked="" type="checkbox"/>
door frame	T1.2	other		<input checked="" type="checkbox"/>	<input checked="" type="checkbox"/>	<input checked="" type="checkbox"/>	<input checked="" type="checkbox"/>	<input checked="" type="checkbox"/>	<input checked="" type="checkbox"/>	<input checked="" type="checkbox"/>	<input checked="" type="checkbox"/>	<input checked="" type="checkbox"/>	<input checked="" type="checkbox"/>
		input from T1.3		<input checked="" type="checkbox"/>	<input checked="" type="checkbox"/>	<input checked="" type="checkbox"/>	<input checked="" type="checkbox"/>	<input checked="" type="checkbox"/>	<input checked="" type="checkbox"/>	<input checked="" type="checkbox"/>	<input checked="" type="checkbox"/>	<input checked="" type="checkbox"/>	<input checked="" type="checkbox"/>
		drinking water		<input checked="" type="checkbox"/>	<input checked="" type="checkbox"/>	<input checked="" type="checkbox"/>	<input checked="" type="checkbox"/>	<input checked="" type="checkbox"/>	<input checked="" type="checkbox"/>	<input checked="" type="checkbox"/>	<input checked="" type="checkbox"/>	<input checked="" type="checkbox"/>	<input checked="" type="checkbox"/>
		heating water		<input checked="" type="checkbox"/>	<input checked="" type="checkbox"/>	<input checked="" type="checkbox"/>	<input checked="" type="checkbox"/>	<input checked="" type="checkbox"/>	<input checked="" type="checkbox"/>	<input checked="" type="checkbox"/>	<input checked="" type="checkbox"/>	<input checked="" type="checkbox"/>	<input checked="" type="checkbox"/>
		ventilation		<input checked="" type="checkbox"/>	<input checked="" type="checkbox"/>	<input checked="" type="checkbox"/>	<input checked="" type="checkbox"/>	<input checked="" type="checkbox"/>	<input checked="" type="checkbox"/>	<input checked="" type="checkbox"/>	<input checked="" type="checkbox"/>	<input checked="" type="checkbox"/>	<input checked="" type="checkbox"/>
		electric cable		<input checked="" type="checkbox"/>	<input checked="" type="checkbox"/>	<input checked="" type="checkbox"/>	<input checked="" type="checkbox"/>	<input checked="" type="checkbox"/>	<input checked="" type="checkbox"/>	<input checked="" type="checkbox"/>	<input checked="" type="checkbox"/>	<input checked="" type="checkbox"/>	<input checked="" type="checkbox"/>
		light switch		<input checked="" type="checkbox"/>	<input checked="" type="checkbox"/>	<input checked="" type="checkbox"/>	<input checked="" type="checkbox"/>	<input checked="" type="checkbox"/>	<input checked="" type="checkbox"/>	<input checked="" type="checkbox"/>	<input checked="" type="checkbox"/>	<input checked="" type="checkbox"/>	<input checked="" type="checkbox"/>
		plug socket		<input checked="" type="checkbox"/>	<input checked="" type="checkbox"/>	<input checked="" type="checkbox"/>	<input checked="" type="checkbox"/>	<input checked="" type="checkbox"/>	<input checked="" type="checkbox"/>	<input checked="" type="checkbox"/>	<input checked="" type="checkbox"/>	<input checked="" type="checkbox"/>	<input checked="" type="checkbox"/>
test applicability		air leakage		<input checked="" type="checkbox"/>	<input checked="" type="checkbox"/>	<input checked="" type="checkbox"/>	<input checked="" type="checkbox"/>	<input checked="" type="checkbox"/>	<input checked="" type="checkbox"/>	<input checked="" type="checkbox"/>	<input checked="" type="checkbox"/>	<input checked="" type="checkbox"/>	<input checked="" type="checkbox"/>
		performance monitoring		<input checked="" type="checkbox"/>	<input checked="" type="checkbox"/>	<input checked="" type="checkbox"/>	<input checked="" type="checkbox"/>	<input checked="" type="checkbox"/>	<input checked="" type="checkbox"/>	<input checked="" type="checkbox"/>	<input checked="" type="checkbox"/>	<input checked="" type="checkbox"/>	<input checked="" type="checkbox"/>
		joint security		<input checked="" type="checkbox"/>	<input checked="" type="checkbox"/>	<input checked="" type="checkbox"/>	<input checked="" type="checkbox"/>	<input checked="" type="checkbox"/>	<input checked="" type="checkbox"/>	<input checked="" type="checkbox"/>	<input checked="" type="checkbox"/>	<input checked="" type="checkbox"/>	<input checked="" type="checkbox"/>
		material check		<input checked="" type="checkbox"/>	<input checked="" type="checkbox"/>	<input checked="" type="checkbox"/>	<input checked="" type="checkbox"/>	<input checked="" type="checkbox"/>	<input checked="" type="checkbox"/>	<input checked="" type="checkbox"/>	<input checked="" type="checkbox"/>	<input checked="" type="checkbox"/>	<input checked="" type="checkbox"/>
		overall system check		<input checked="" type="checkbox"/>	<input checked="" type="checkbox"/>	<input checked="" type="checkbox"/>	<input checked="" type="checkbox"/>	<input checked="" type="checkbox"/>	<input checked="" type="checkbox"/>	<input checked="" type="checkbox"/>	<input checked="" type="checkbox"/>	<input checked="" type="checkbox"/>	<input checked="" type="checkbox"/>
		other (please comment)		<input type="checkbox"/>	<input type="checkbox"/>	<input type="checkbox"/>	<input type="checkbox"/>	<input type="checkbox"/>	<input type="checkbox"/>	<input type="checkbox"/>	<input type="checkbox"/>	<input type="checkbox"/>	<input type="checkbox"/>
test applicability construction phase		laboratory		<input type="checkbox"/>	<input type="checkbox"/>	<input type="checkbox"/>	<input type="checkbox"/>	<input type="checkbox"/>	<input type="checkbox"/>	<input type="checkbox"/>	<input type="checkbox"/>	<input type="checkbox"/>	<input type="checkbox"/>
		factory		<input type="checkbox"/>	<input type="checkbox"/>	<input type="checkbox"/>	<input type="checkbox"/>	<input type="checkbox"/>	<input type="checkbox"/>	<input type="checkbox"/>	<input type="checkbox"/>	<input type="checkbox"/>	<input type="checkbox"/>
		on site		<input checked="" type="checkbox"/>	<input checked="" type="checkbox"/>	<input checked="" type="checkbox"/>	<input checked="" type="checkbox"/>	<input checked="" type="checkbox"/>	<input checked="" type="checkbox"/>	<input checked="" type="checkbox"/>	<input checked="" type="checkbox"/>	<input checked="" type="checkbox"/>	<input checked="" type="checkbox"/>
		other (please comment)		<input type="checkbox"/>	<input type="checkbox"/>	<input type="checkbox"/>	<input type="checkbox"/>	<input type="checkbox"/>	<input type="checkbox"/>	<input type="checkbox"/>	<input type="checkbox"/>	<input type="checkbox"/>	<input type="checkbox"/>
special requirements regarding site logistics		yes (please comment below)		<input checked="" type="checkbox"/>	<input checked="" type="checkbox"/>	<input checked="" type="checkbox"/>	<input checked="" type="checkbox"/>	<input checked="" type="checkbox"/>	<input checked="" type="checkbox"/>	<input checked="" type="checkbox"/>	<input checked="" type="checkbox"/>	<input checked="" type="checkbox"/>	<input checked="" type="checkbox"/>
time schedule		available (provide format)		<input checked="" type="checkbox"/>	<input checked="" type="checkbox"/>	<input checked="" type="checkbox"/>	<input checked="" type="checkbox"/>	<input checked="" type="checkbox"/>	<input checked="" type="checkbox"/>	<input checked="" type="checkbox"/>	<input checked="" type="checkbox"/>	<input checked="" type="checkbox"/>	<input checked="" type="checkbox"/>
		xls		<input checked="" type="checkbox"/>	<input checked="" type="checkbox"/>	<input checked="" type="checkbox"/>	<input checked="" type="checkbox"/>	<input checked="" type="checkbox"/>	<input checked="" type="checkbox"/>	<input checked="" type="checkbox"/>	<input checked="" type="checkbox"/>	<input checked="" type="checkbox"/>	<input checked="" type="checkbox"/>
		Site logistics: the renovation process is planned in 2017-2018. Building access based on permission from the project owner (Camelot Real Estate). INSITER demonstration activities are in synergy with the H2020 project P2Endure.											

Figure 44: Inventory list



**5.2 Storyboards for field demonstration activities and demo cases**

Demo case 1: Building envelope – Inspection of deviations or flaws at the placement of new façade panels and windows

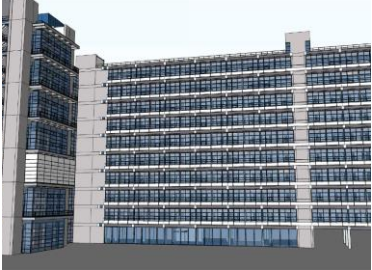
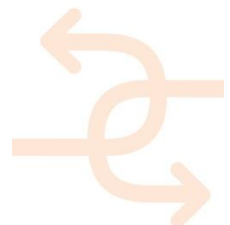
Storyboard: Check and approval of measured values (self-inspection at component level)

- The installed façade panels and windows in real live will be compared to the BIM model.
- Inaccuracies and defects will be identified using:
  - Partial geometrical survey using 3D laser scanning.
  - Thermal scanning and acoustic measurement at critical joints in the façade system.
- Research question to be resolved: After field measurement, how to determine that the realised quality is acceptable / within the accepted tolerance; how to set the threshold?

Specific activity related to Construction Phase	Demonstration actions
Checking the panels delivered on building site	Scanning RFID or QR in prefab panels, and retrieval of component's ID in BIM
Deployment of BIM models for on-site use	Loading the partial BIM model onto a tablet (iPad), showing the specific parts of the façade including the panels
Check whether the panels are 'perfectly' aligned; check the gaps between panels and at the joints panels and floor slabs	Use of laser measuring / alignment tool
Check if the measured values (i.e. the sizes of the gaps) are acceptable (within the tolerance) for: <ul style="list-style-type: none"> <li>- individual gaps between panels</li> <li>- cumulative gaps in the case of a series of panels</li> </ul>	Entering the measurement results in the software tool (mobile inspection tool); operate the software to check whether the measured values are acceptable; if a defect or error is identified, taking pictures of the particular object; sending the on-site inspection information to be synchronised in the database

Demo case 2: MEP system – AR on-site simulation at the assembly / installation of a part of the new MEP system

Storyboard: Check of installation quality (self-inspection at system level)

- Modelling the MEP system of the new situation in BIM (by Camelot; in synergy with P2Endure project).
- Checking the BIM model of the MEP system created by Camelot by virtual clash detection.
- Preparing BIM-based AR visualization of the new MEP system.
- On-site test deployment of AR for visual comparison between BIM model and realization of parts of the MEP system

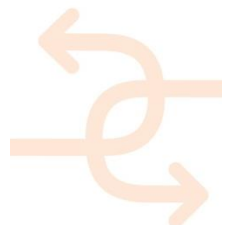

Specific activity related to Construction Phase	Demonstration actions
Checking the particular MEP components delivered on the building site.	Scanning RFID or QR in prefab panels, and retrieval of component's ID in BIM. This stage requires retrieving a list of materials from the BIM and collecting the (prefabricated) components that have to be installed.
Deployment of Augmented Reality tool at the particular location where the MEP components are installed	Loading the BIM on a portable device (tablet); setting the positioning and orientation points for AR; starting AR visualisation
Visual inspection of the installation work using AR	Project AR overlay over the installed components/ducting to verify correct installation, course and location

Demo Case 3: Mobile inspection tool for post-renovation condition assessment

Storyboard: Post-renovation building inspection (self-inspection at commissioning)

- Configuring the software for condition assessment after renovation; embedding the “as-built” BIM model into the inspection software tool.
- Verifying the “as-built” BIM model by updating BIM with inspection data after renovation.



Specific activity related to Construction Phase	Demonstration actions
<b>5D BIM preparation</b>	Retrieving the relevant data and integrating project management information in 5D BIM (3D model + cost and planning information)
<b>Virtual clash detection of geometric information</b>	Operating the software tool for clash detection to verify the BIM model
<b>Off-site simulation of 3D construction process</b>	Displaying the chronologic construction steps on the mobile device
<b>On-site AR simulation of 3D construction process</b>	Setting-up AR positioning; loading the relevant part of the BIM model (according to the location/positioning); displaying the chronologic construction steps in the AR tool on mobile device

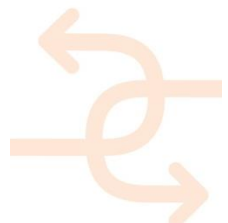

## 6. Sustainer Homes, Delft, NL

This demonstration case has just recently been identified for INSITER through collaboration with the project developer Sustainer Homes. This young company has a high ambition regarding sustainable prefab buildings. The INSITER contact partner for this case is SBRCURnet. INSITER consortium has decided to take this very interesting opportunity to organise a demonstration case.

Sustainer Homes and INSITER partners have defined the field demonstration case of new, to be realised building in Delft, the Netherlands, located at the campus of Delft Technical University (TU Delft). More information (currently in Dutch) is available on: <https://www.sustainerhomes.nl/projecten/green-village/>

At the moment of writing of this deliverable, the project plans are under development as well as a synergy agreement with the Sustainer Homes. In this report, the building concept and preliminary designs are presented. The purpose of the inventory list is to gain general information from the demonstrators with regard to their qualification for testing needs. The detailed elaboration of the demonstration case will follow shortly as this project continues to evolve, and the outcomes will be reported in the follow-up deliverables of INSITER. The information will be updated continuously and accessible in the INSITER SharePoint website.



Figure 45: visualisation

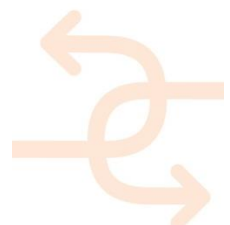



Figure 46: Project site in Delft, NL

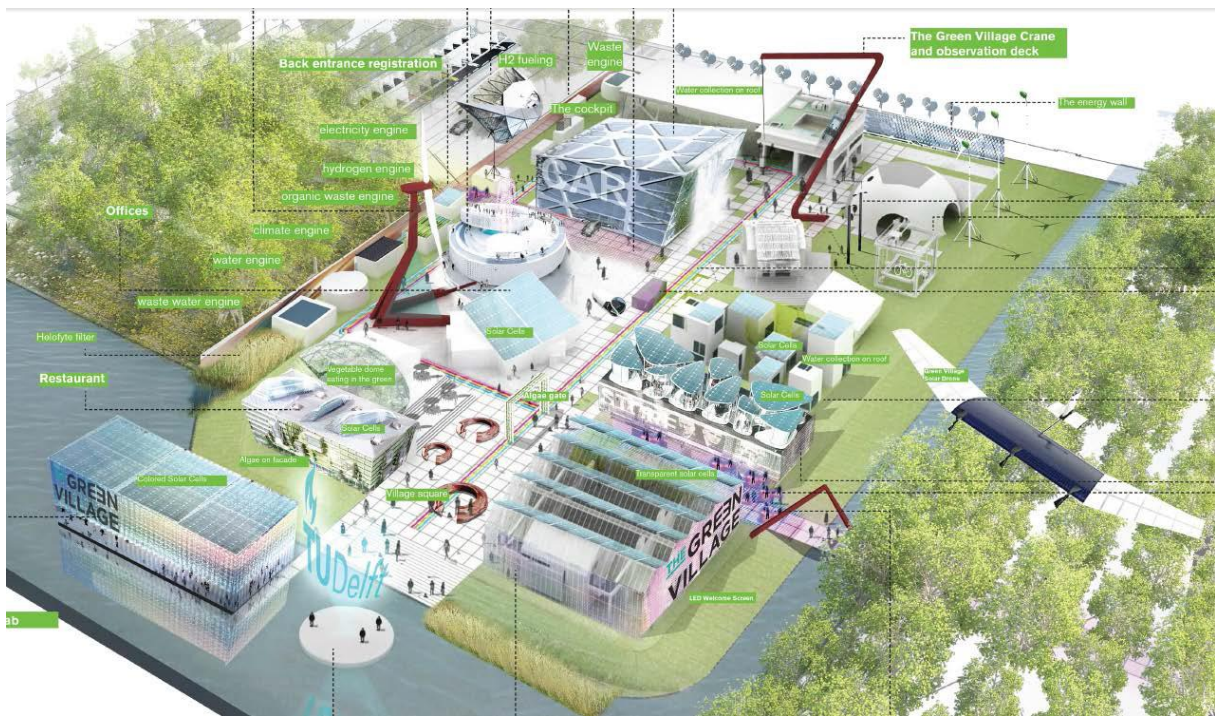
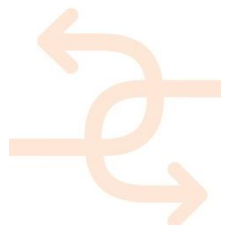

Figure 47: Artist impression ( <http://www.thegreenvillage.org>)



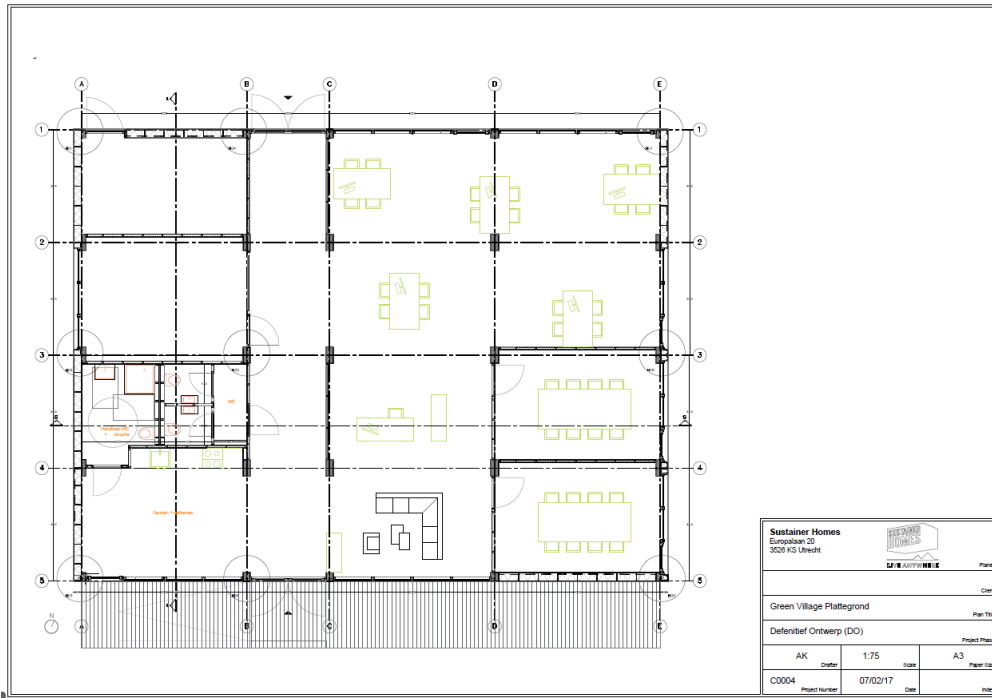

Figure 48: floorplan

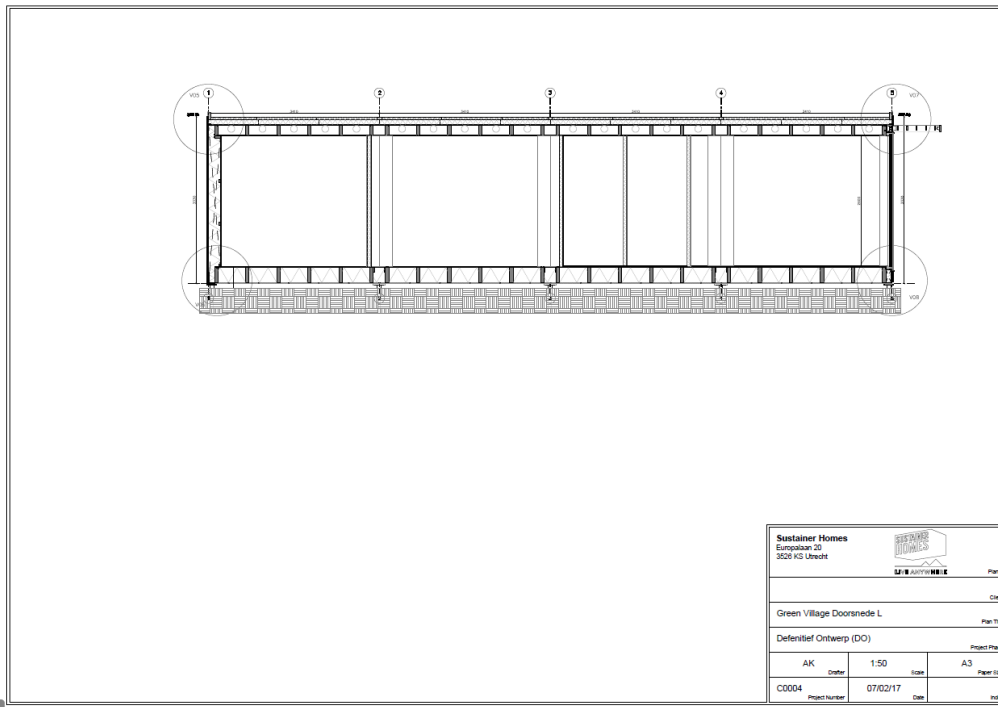
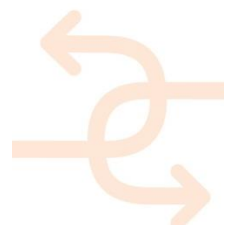

Figure 49: vertical section



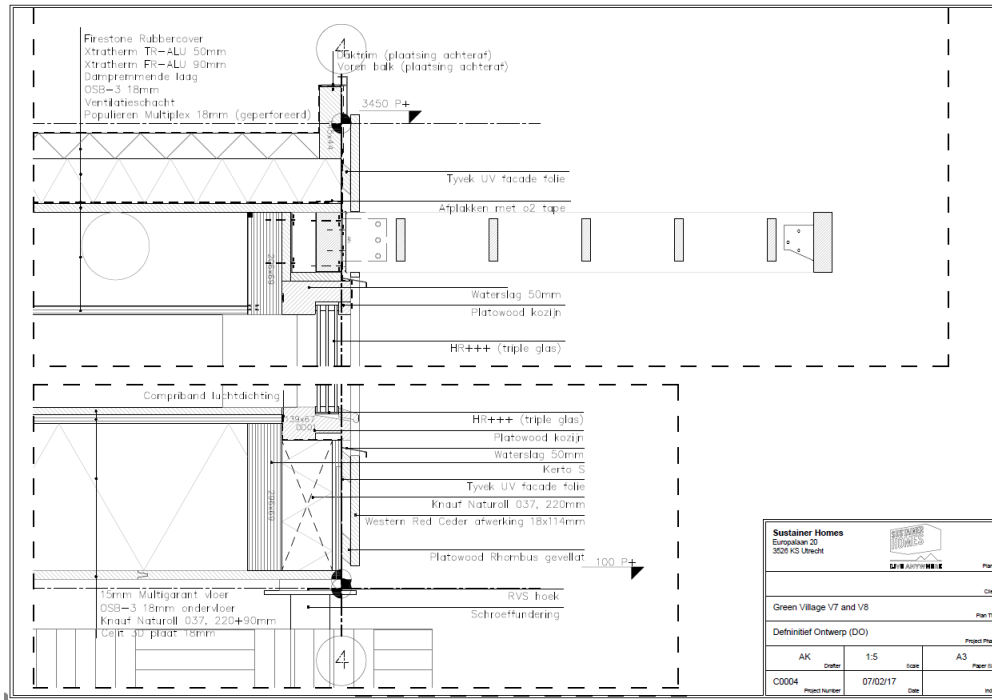

Figure 50: vertical detail

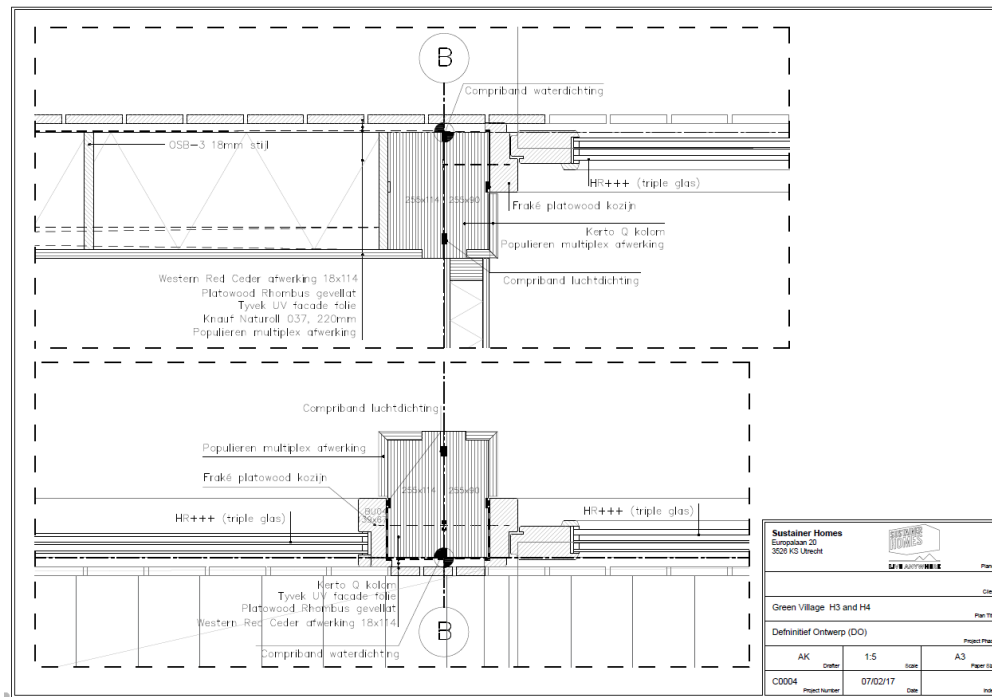
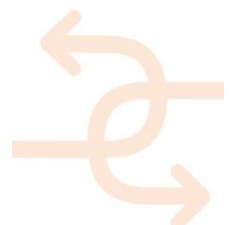

Figure 51: horizontal detail





### WP5 inventory list

no						
name		Sustainer Home - Office Lab 'the green village'				
country		The Netherlands				
year of completion		2017				
volume m <sup>3</sup>		Approximately 645 m3				
number of storeys		1				
new/existing		new construction				
use		office				
		available data				
		<input type="checkbox"/> 2D analog <input checked="" type="checkbox"/> 2D digital <input type="checkbox"/> 3D digital <input type="checkbox"/> BIM <input type="checkbox"/> other				
construction exterior walls	input from	wood	<input type="checkbox"/>	<input checked="" type="checkbox"/>	<input type="checkbox"/>	<input type="checkbox"/>
window frame material		wood	<input type="checkbox"/>	<input checked="" type="checkbox"/>	<input type="checkbox"/>	<input type="checkbox"/>
door frame	T1.2	wood	<input type="checkbox"/>	<input checked="" type="checkbox"/>	<input type="checkbox"/>	<input type="checkbox"/>
	input from	drinking water	<input type="checkbox"/>	<input type="checkbox"/>	<input type="checkbox"/>	<input type="checkbox"/>
		heating water	<input type="checkbox"/>	<input type="checkbox"/>	<input type="checkbox"/>	<input type="checkbox"/>
	T1.3	ventilation	<input type="checkbox"/>	<input type="checkbox"/>	<input type="checkbox"/>	<input type="checkbox"/>
		electric cable	<input type="checkbox"/>	<input type="checkbox"/>	<input type="checkbox"/>	<input type="checkbox"/>
		light switch	<input type="checkbox"/>	<input type="checkbox"/>	<input type="checkbox"/>	<input type="checkbox"/>
		plug socket	<input type="checkbox"/>	<input type="checkbox"/>	<input type="checkbox"/>	<input type="checkbox"/>
test applicability		air leakage	<input type="checkbox"/>	<input type="checkbox"/>	<input type="checkbox"/>	<input type="checkbox"/>
		performance monitoring	<input type="checkbox"/>	<input type="checkbox"/>	<input type="checkbox"/>	<input type="checkbox"/>
		joint security	<input type="checkbox"/>	<input type="checkbox"/>	<input type="checkbox"/>	<input type="checkbox"/>
		material check	<input type="checkbox"/>	<input type="checkbox"/>	<input type="checkbox"/>	<input type="checkbox"/>
		overall system check	<input type="checkbox"/>	<input type="checkbox"/>	<input type="checkbox"/>	<input type="checkbox"/>
		other (please comment)	<input type="checkbox"/>	<input type="checkbox"/>	<input type="checkbox"/>	<input type="checkbox"/>
test applicability construction phase		laboratory	<input type="checkbox"/>	<input type="checkbox"/>	<input type="checkbox"/>	<input type="checkbox"/>
		factory	<input checked="" type="checkbox"/>	<input type="checkbox"/>	<input type="checkbox"/>	<input type="checkbox"/>
		on site	<input checked="" type="checkbox"/>	<input type="checkbox"/>	<input type="checkbox"/>	<input type="checkbox"/>
		maintenance	<input type="checkbox"/>	<input type="checkbox"/>	<input type="checkbox"/>	<input type="checkbox"/>
special requirements regarding site logistics		select	<input type="checkbox"/>	<input type="checkbox"/>	<input type="checkbox"/>	<input type="checkbox"/>
time schedule		select	<input type="checkbox"/>	<input type="checkbox"/>	<input type="checkbox"/>	<input type="checkbox"/>

Figure 52: Inventory list

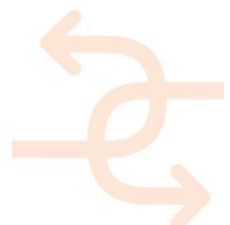



## 7. Dragados Factory, ES

### 7.1 Site characteristics and description

DRAGADOS has been involved in the business of modular construction since 1972 and, from day one, this business has been under constant improvement. It currently is a perfect alternative to traditional construction, without any limitations in terms of specifications and finishing, needing 50% less execution time and with a higher capability to adapt in order to meet clients' requirements.

The prefabricated buildings DRAGADOS produces consist of a set of modules which are almost entirely produced in the factory and then shipped on-site for assembly.

The factory where these modules are manufactured is in the South of Spain, in a town called Las Cabezas de San Juan near Seville. It opened in 1972 and has been continuously active ever since. The total surface of the factory is 100.000 m<sup>2</sup>, of which over 20.000 m<sup>2</sup> are dedicated to the production process, which takes place in the several industrial units (hangars) and the auxiliary workshops.

The industrial buildings and workshops are equipped with all the production, manipulation and transportation means necessary to efficiently and safely deliver high quality buildings which meet any requirement set by clients.



Figure 53: Factory layout

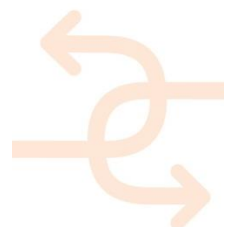



*Figure 54: Industrial buildings for manufacturing and storage*



*Figure 55: Industrial buildings for manufacturing and storage*





*Figure 56: Industrial buildings for manufacturing and storage*



*Figure 57: Industrial buildings for manufacturing and storage*

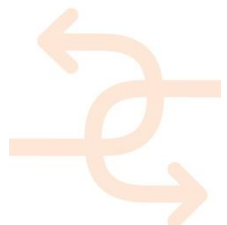
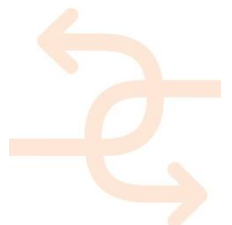



Figure 58: Industrial buildings for manufacturing and storage



Figure 59: Industrial buildings for manufacturing and storage





*Figure 60: Industrial buildings for manufacturing and storage*



*Figure 61: Industrial buildings for manufacturing and storage*

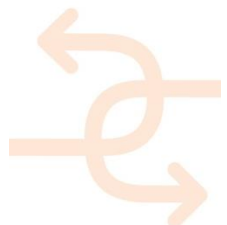
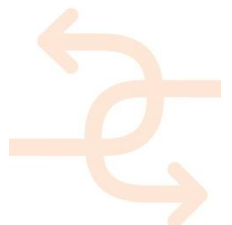



Figure 62: Industrial buildings for manufacturing and storage



Figure 63: Industrial buildings for manufacturing and storage



## 7.2 Storyboard

### **Storyboard for the demonstration in Las Cabezas factory:**

Description of the demonstration for the purpose of **field validation** of the prototype INSITER Systems and tools – detailed test description due for D5.4 ( end of 2017).

The field validation will use the results of lab testing (D5.2) and the initial trials on the factory. As well, the input given by WP1 – see e.g. D1.1, D1.4, D 1.6.

## 7.3 Demo case selection

The **field validation** will address construction & assembly phases, demonstrating the INSITER tools and methodology using different construction processes as Demo Cases.

Work to do:

1. Objectives of the validation activities
2. Description of the current fabrication and assembly process and QA process.
3. Choice of the important construction processes relevant to be tested off-on site and short description of demo case
4. Detailed description of those processes and the tests to be carried out.
5. Check of feasibility by involved partners and assignment of responsibilities for each project

1. Objectives of the validation activities

To gain insight on how the use of the technologies, systems and processes of self-inspection and self-instruction developed in INSITER can contribute to improve both the current fabrication and assembly process followed in the factory to manufacture prefabricated buildings and the company's Quality Assurance process.

There are three main factors that have a strong influence on the final quality and energy efficiency of the prefabricated buildings produced in the factory. These are the design project, on which DRA has a limited say, the off-site manufacturing and on-site assembly process and the QA process followed throughout the whole process.

Tools and process oriented towards workers self-instruction, focussed on the right key processes, will prevent common mistakes and reduce execution times and non-productive times. Self-inspection oriented support processes will contribute to ensure that the final product complies (or exceeds) any pre-set requirement (from the client, regulation or internal).

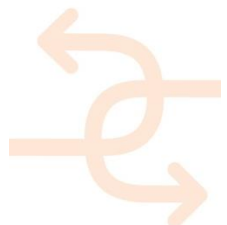

2. Description of the current fabrication and assembly process and QA process.

The CARACOLA modular system allows to manufacture and assembly single or multi story buildings composed of three-dimensional modules with metallic structure and welded joints which can be assembled horizontally or vertically.

These modules are manufactured off-site (in the factory) and include envelope and inner partitions, finishing works and necessary services.

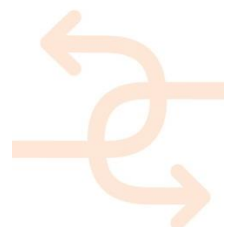

*Figure 64: Examples of buildings using the CARACOLA system*

Once the modules are manufactured, they are assembled in the factory to check and then disassembled as pre-assembly is carried out.



*Figure 65: Modules assembly off-site*





Once on-site, the modules are joined to the foundations, assembled to each other, and services are connected among modules. The building is then finished.

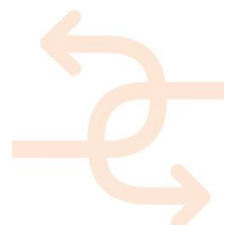

Figure 66: Modules final assembly on-site

Main features of this system are versatility, since almost any kind of building can be produced; execution control since most of the activities are done off-site and geographical adaptability since individual modules can be taken anywhere by road.

CARACOLA's system main application fields are in the sectors of education, administration, sanitary, temporary facilities, etc.

Some of the execution processes carried out to produce the prefab buildings will be selected as demo cases for the INSITER tools/methodologies. In order to carry out this selection, the QA process followed in DRAGADOS is being analysed in order to detect how INSITER tools/methodologies can help to improve our QA process and how this process should be modified in order to embrace the advantages that the use of these methodologies and tools bring. The current QA process is a paper based Inspection Points Programme that heavily relies on the experience of the worker performing the inspection in order to assess the quality of the product.



Example of an IPP for GRC panels:

<b>DRAGADOS</b>		<b>INSPECTION POINTS PROGRAMME (I.P.P.)</b>				<b>PLAN</b>	#REF!
						<b>SHEET</b>	
						<b>VERSION</b>	#REF!
						<b>DATE</b>	#REF!
<b>Business area</b>		GRC					
<b>Site:</b>		FACTORY				<b>CODE:</b>	297/100
<b>ACTIVITY:</b>		GRC PANELS FABRICATION				<b>I.P.P. N°:</b>	2
<b>Num ber</b>	<b>OPERATIONS</b>	<b>PROCE DURE</b>	<b>TYPE OF INSPECTIO N</b>	<b>RESPO NSIBLE</b>	<b>PRECOU FE FACTA</b>	<b>HOLD POINT</b>	<b>SPECIFICATIONS</b>
<b>a)</b>	<b>Geometry check</b>		MET	SITE ENGINE ER	100%	YES	
	Total height and length						For measurements below 3m: ± 3 mm. See IPP detail For measurements over 3m: ± 3 mm/m cwith a mx of
	Diagonals						Diference between opposite diagonals < 3mm
	Thickness						+ 10 mm / - 6 mm. See IPP detail
	Other dimensions						According to tolerances in the detail IPP
<b>b)</b>	<b>Thickness check</b>	DIT 367/R	MET	SITE ENGINE ER	100%	SO	Thickness is measured using a gauge. 6 times if the panel surface is equal to or below 6m2. Otherwise, 12 times. Nominal thickness 10mm; Tolerance: -0mm /+ 5 mm.
<b>c1)</b>	<b>Sandwich panels check</b>						
	Polystyrene placement and nerves fabrication		VIS	SITE ENGINE ER	100%	NO	Unless specified otherwise, nerves will be placed every meter and will have a thickness of 15-20 mm. A polystyrene board will be placed. GRC will be sprayed around its perimeter to fabricate the nerves. Then a second board will be placed next to the first one and the spraying is done again. The process is repeated until the pnel is completed. Never place all the polystyrene boards at the same time, leaving the spaces for the nerves and then spary all the concrete at once.
	Fixing system layout		MET	SITE ENGINE ER	100%	NO	Fixing elements will be placed according to the tolerances specified in the PPI detail.
	Panels identification		VIS	SITE ENGINE ER	100%	NO	The populated identification label will be placed on the inner side of the panel, ensuring it is correctly adhered to the panels. Besides, the panel code and the fabrication date will be written on the panel's inner side
<b>c2)</b>	<b>Stud-Frame panels check</b>						
	Metallic frame placement		VIS	SITE ENGINE ER	100%	NO	The frame will not be placed directly on top of the concrete to avoid marks in the exposed side of the panel. Specific tools will be used, complying with the specified panef's maximum thickness. The frame will be placed parallel to the panel sides.
	Spaying over connectors		VIS	SITE ENGINE ER	100%	NO	All connectors will be sprayed upon, leaving just the angle free. See IPP detail.
	Panels identification		VIS	SITE ENGINE ER	100%	NO	The populated identification label will be placed on the inner side of the panel, ensuring it is correctly adhered to the panels. Besides, the panel code and the fabrication date will be written on the panel's inner side
<b>d)</b>	<b>Visual inspection</b>		VIS	SITE ENGINE ER	100%	YES	No harmed areas or visual defects ( cracks, stains, shattered areas, etc.)
VIS: Visual Inspection							
MET: Measurement							



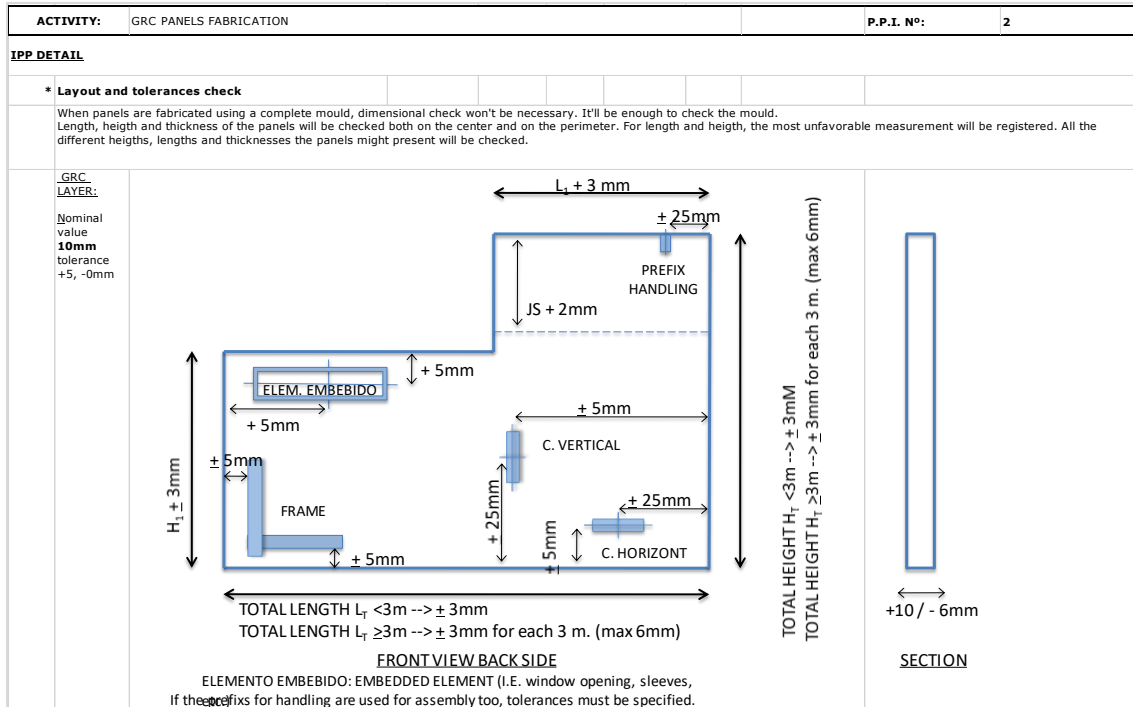

Figure 67: Example of an IPP for GRC panels

- Choice of the important construction processes relevant to be tested off-on site and short description of demo case:

According to the professionals in the factory, the following are the most critical processes affecting the final quality of the final building.

- At factory level:
  - Roof panel fabrication and assembly
  - GRC façade panels fabrication
  - GRC façade panels assembly in the module
  - Joints check ( panel-panel, panel-roof, panel-floor slab)
  - MEP/HVAC components installation on the module
  - Pre-assembly of modules off-site
  - Quality/Energy performance checks (thermal, acoustic, air leakage, etc.)
- At building level (depending on the existence of a real project during 2017,2018)
  - Joining modules with foundation
  - Assembly of modules on site
  - MEP integration among modules



Examples of critical process identified by the factory quality manager can be seen below:

- Slabs perimeter beam



Figure 68: slab perimeter beam

- Joints between GRC sandwich panels with the roof for the base slab

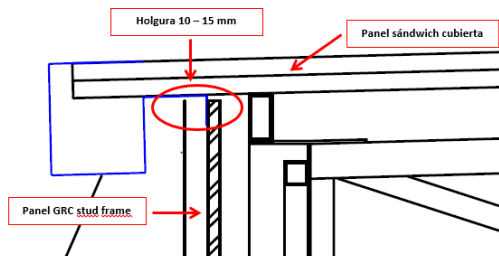

Detalle.1: Encuentro entre panel GRC stud frame y panel sándwich de cubierta

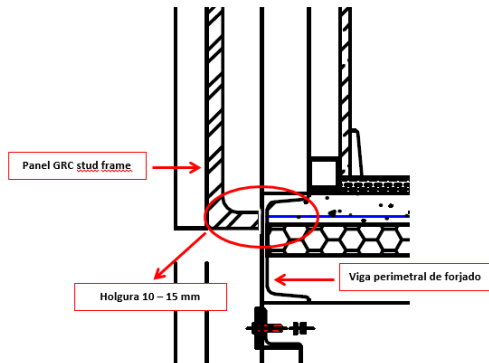
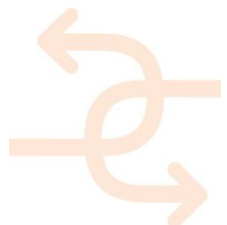

Figure 69: vertical section facade system



## 8. Conclusions

The 6 demonstrators foreseen offer a wide range of at least 18 case studies listed and explicitly described as demo cases in chapters 2 to 7. The preparation of qualified field validation protocols has been coordinated between the different demonstration projects related to their specific characteristics. Furthermore the responsible partners for test performing and analysis have been assigned to the demo cases. The storyboards involve all stakeholders and their characteristic demands in order to assure the interaction related to quality issues.

The objectives for follow-up actions are to detail the demo cases and develop maps of duties related to testing and validation needs for the INSITER tool and the methodology survey.

The validation will be done on site and is prepared in this deliverable D5.3 –due at M27 and will be further elaborated in *D5.4 Field validation report and recommendations* –due at M36. The test on site will be described in detail in *D5.5 Field demonstration set-up* –due at M39, the results of the site testing will be reported in *D5.6 Field demonstration report* –due at M45 and finally analysed in *D5.7 Cross-case analysis and benchmarking* –due at M48.

In addition the equipment needed to perform the tests is described in the demo cases and the expected results and thresholds are documented. As preliminary tests have been performed already at laboratory, factory and at field level, too, e.g. for laser scanning to BIM processes, the integration and calibration of the testing equipment is prepared for further action at the factory and on site at the same time.

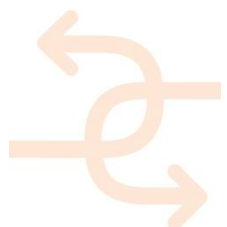

## 9. APPENDIX 1 – Storyboard 1

### STORYBOARD 1

#### PREFAB FAÇADE SYSTEM FOR ROOFTOP EXTENSION

*Klaus Luig/ 3L*



INSITER

INSITER INTUITIVE  
SELF-INSPECTION  
TECHNIQUES

INSITER INTUITIVE  
SELF-INSPECTION  
TECHNIQUES

### SITUATION: HEALTH CENTRE COLOGNE





2

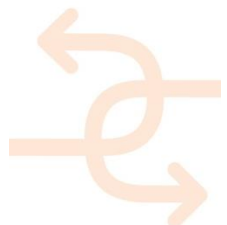

**SITUATION: HEALTH CENTRE COLOGNE  
PLANNED ROOFTOP EXTENSION**



3

**SITUATION: HEALTH CENTRE COLOGNE  
PLANNED ROOFTOP EXTENSION**



4

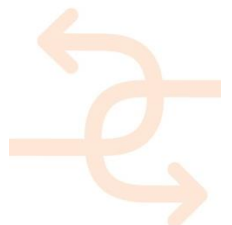

**SITUATION: HEALTH CENTRE COLOGNE  
STRUCTURAL ANALYSIS ON HAND (500 PAGES)**

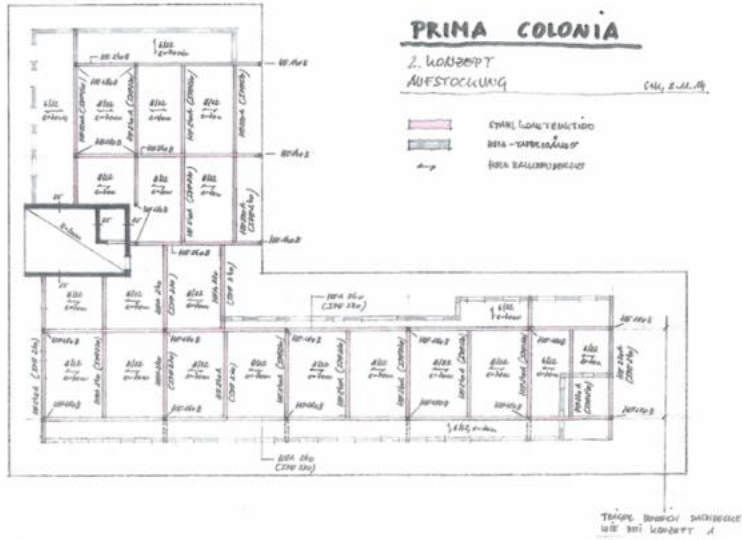

5

**SITUATION: HEALTH CENTRE COLOGNE  
STRUCTURAL ANALYSIS ON HAND**

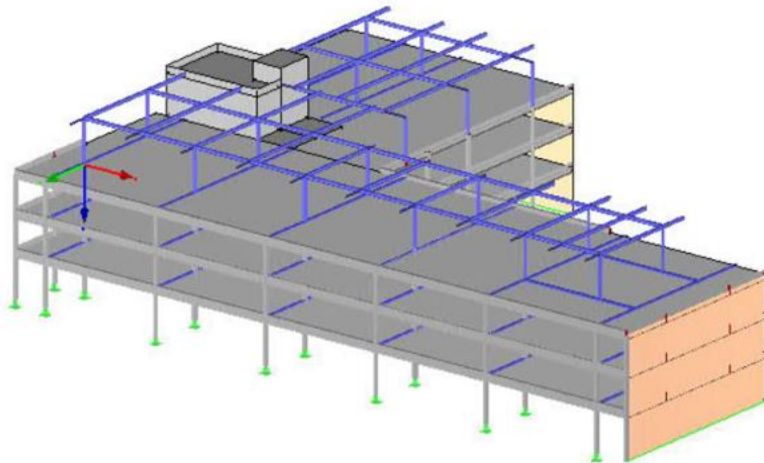

6

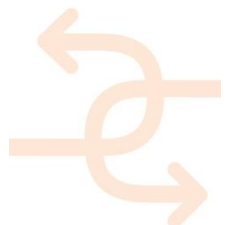



**SITUATION: HEALTH CENTRE COLOGNE  
STRUCTURAL ANALYSIS ON HAND**

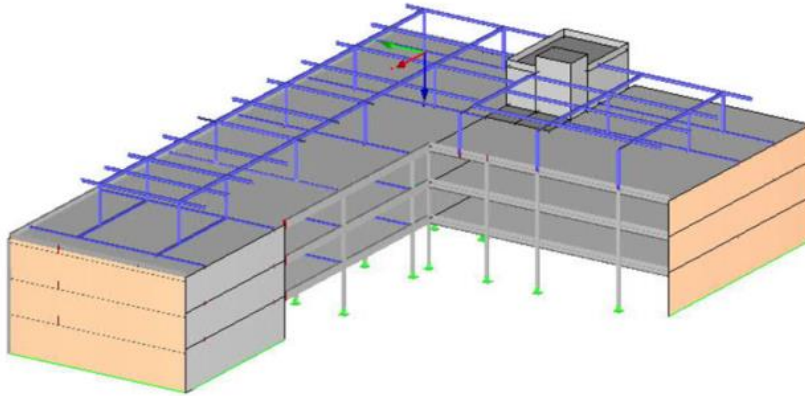

**SITUATION: HEALTH CENTRE COLOGNE  
OFFER READY FOR COMMISSIONING**

Projekt: Prima Colonia, Aufstockung Gesundheitszentrum und  
Seniorenpflege in Köln-Widdersdorf Datum:  
Angebots-Nr.:  
Seite:

armieren.

01.01.02 Zertifizierte Holzrahmenbauaußenwände werksmäßig  
vorgefertigt (inkl. der erforderlichen Güteüberwachung)  
**F-30B**

Die Wände werden wie folgt hergestellt:

- innenseitige Bekleidung mit einer Gipskartonplatte 12,5 mm stark im Bereich der Nutzflächen, unverspachtelt
- innenseitige Bekleidung mit OSB-3, 15 mm stark
- Ständerwerk gem. Statik (Pfosten, Schwelle, Rähm) aus 6/24 F1/Ta Konstruktionsvollholz, unbehandelt, gehobelt und gefast, techn. getrocknet, Plastermaß beträgt 62,5 cm
- die Dämmung innerhalb der Ständergefache aus 240 mm Steinwolle, WLG 035 mit 10 mm Übermaß einlegen
- die außenliegende A1 Ferrocem Powerpanel HD Platte 12,5mm stark

herstellen und einschl. der Abklebung der luftdichten Ebene (innenseitige OSB) mit einem zugelassenen Klebeband fertig verladen ab Werk.

Die außenliegende Ferrocemplatten planen mind. 5mm Schichtstärke incl. Gewebeeinlage und die erforderlichen Anschließprofile im Werk armieren.

Sockelausbildung mit einer 15mm starken OSB Platten einschl. der erforderlichen Sockelabdichtung gem. Herstellervorschriften mit einer Woffin IB Bahn werkseitig mit einem Sprühkleber aufgetragen und mechanisch befestigt. (Sockelhöhe gesamt max. 50 cm)

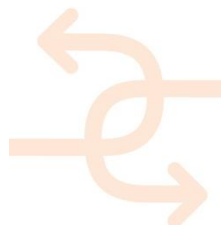
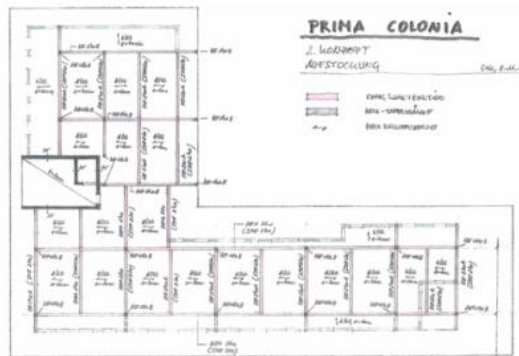

## STORYBOARD 1 PREFAB FAÇADE SYSTEM FOR ROOFTOP EXTENSION

Klaus Luig/ 3L



INSITER INTUITIVE SELF-INSPECTION TECHNIQUES

### STORYBOARD 1, CONTENT:

Chronology of activities representing a specific construction activity	Content to be presented or demonstrated	Demonstration action of Accessory meeting	Responsible partner	
1. Checking the panels delivered on building site <i>For example:</i>	<ul style="list-style-type: none"> <li>- RFID or QR in prefabricated panels</li> <li>- Removal of component's ID in BIM</li> </ul>	<ul style="list-style-type: none"> <li>- 1 presentation slide with illustrations</li> <li>- 1 presentation slide with illustrations</li> </ul>	<ul style="list-style-type: none"> <li>- 3L</li> <li>- HVAC</li> </ul>	
2. Handling of the panels on the building site (loading, offloading, positioning) <i>For example:</i>	<ul style="list-style-type: none"> <li>- Examples of assembly manual from a prefabricated panel supplier</li> </ul>	1 short video example	3L	
3. Loading the partial BIM model into a tablet or smartphone, showing the specific parts of the facade including the panels	<ul style="list-style-type: none"> <li>- Loading BIM model of Cologne Case into iPad, viewing the relevant building parts or components</li> </ul>	Recorded software demonstration of the activity	DEMO (off-chart)	
4. Installation process of the facade panels of the new storey (roof-top extension)	<ul style="list-style-type: none"> <li>- Animation of the panel installation using BIM of Cologne case, similar to the installation panel installation at the refrigerator</li> </ul>	Short animation	PHO/PA	
Workshop progress	<ul style="list-style-type: none"> <li>- 1. Demonstration workers assembling the prefabricated panels on-site</li> </ul>	<ul style="list-style-type: none"> <li>- An example of an existing video about prefabricated panel assembly on-site</li> </ul>	<ul style="list-style-type: none"> <li>- Short video examples, for instance</li> </ul>	3L
Self-inspection at the level of building component	<ul style="list-style-type: none"> <li>- Use of laser measuring / alignment tool</li> <li>- Removal from drawings (UNIFPM) into short 1-2 presentation slides or a short movie</li> </ul>	<ul style="list-style-type: none"> <li>- If the device is available at UNIFPM, then demonstrate in situ, if not, then 1-2 presentation slides or a short movie</li> </ul>	UNIFPM, CERTIF	
<ul style="list-style-type: none"> <li>- For example:</li> </ul>	<ul style="list-style-type: none"> <li>- <a href="https://www.youtube.com/watch?v=1818590010k">https://www.youtube.com/watch?v=1818590010k</a> or <a href="https://www.youtube.com/watch?v=3818590010k">https://www.youtube.com/watch?v=3818590010k</a> or <a href="https://www.youtube.com/watch?v=5818590010k">https://www.youtube.com/watch?v=5818590010k</a> or <a href="https://www.youtube.com/watch?v=7818590010k">https://www.youtube.com/watch?v=7818590010k</a></li> </ul>			

Colour marking levels of the measured presentation and actions:

- Blue: presentation / illustration / video from reference material or literature
- Red: recorded software presentation or BIM animation
- Yellow: live demonstration using devices in the lab

7. Insert the measured values in the software, and store the data	Show the functionality / feature in the WP3 software	Recorded software demonstration of this activity, if not possible, then 1 presentation slide showing the proposed software feature with 'lock-up screenshots'	DEMO (off-chart)
8. Check if the measured values in the view of the (panels) are acceptable (within the tolerance) for individual gaps	Show the functionality / feature in the WP3 software (e.g. validation of measured values against 'range limit' or 'threshold limit')	1 presentation slide showing the proposed software feature with 'lock-up screenshots'	DEMO (off-chart)
9. Approval and decision-making supported by the software	Show functionality included in the WP3 software: <ul style="list-style-type: none"> <li>- if the 'validation' is OK, then self-approved by workers</li> <li>- if the 'validation' is not OK, then send an inquiry to the site supervisor</li> </ul>	1-2 presentation slides showing the proposed software feature with 'lock-up screenshots'	DEMO (off-chart)
Self-inspection at the level of room or building section			
10. Measurement of the thermal performance (thermal transmittance) of the facade	Measure the actual U-value of a part of the facade after on-site assembly	Real demonstration of the use of thermal measurement device on the panel of the 'refrigerator' in UNIFPM lab	UNIFPM
11. Insert the measured values in the software, and store the data	Show functionality included in the WP3 software	1-2 presentation slides showing the proposed software feature with 'lock-up screenshots'	DEMO (off-chart)
12. Check if the measured values are acceptable	Show the functionality / feature in the WP3 software (e.g. validation of measured values against 'range limit' or 'threshold limit')	1-2 presentation slides showing the proposed software feature with 'lock-up screenshots'	DEMO (off-chart)
13. Approval and decision-making supported by the software	Show functionality included in the WP3 software: <ul style="list-style-type: none"> <li>- if the 'validation' is OK, then self-approved by workers</li> <li>- if the 'validation' is not OK, then send an inquiry to the site supervisor</li> </ul>	1-2 presentation slides showing the proposed software feature with 'lock-up screenshots'	DEMO (off-chart)
14. Update of the BIM model = creation of 'as-built BIM'	Generating an updated BIM model that contains measured data, including geometric revisions in case of discrepancies between design and assembly	1-2 presentation slides showing the proposed solution	HVC
15. Generation of a list of objects (parts or specifications) based on the comparison between 'as-built BIM' and 'as-built part'	BIM4D checking and verifying	1-2 presentation slides in a recorded software demonstration of BIM comparison / reviewing	HVC

10

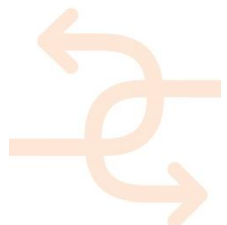



**Storyboard 1: “Prefab façade system for rooftop extension”**

[storyboard director: 3L (Klaus & Dieter)]

Colour-marking codes of the required preparation and actions:

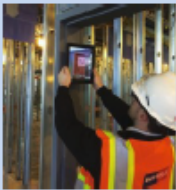
- Blue:	presentation / illustration / video from reference materials or literature
- Red:	recorded software presentation or BIM showcase
- Yellow:	live demonstration using devices in the lab

Chronological storyline representing a specific on-site construction activity	Content to be presented or demonstrated	Demonstration action at Ancona meeting	Responsible partner	
<i>On-site preparation</i>				
1	Checking the panels delivered on building site  For example: <div style="display: flex; justify-content: space-around; margin-top: 10px;">   </div>	<ul style="list-style-type: none"> <li>- RFID and QR in prefab panels</li> <li>- Retrieval of component's ID in BIM</li> </ul> <ul style="list-style-type: none"> <li>- 1 presentation slides with illustrations</li> <li>- 1 presentation slide with illustrations</li> </ul>	<ul style="list-style-type: none"> <li>- 3L</li> <li>- HVC</li> </ul>	
<i>Self-instruction</i>				
2	Handling of the panels on the building site (storing, lifting, positioning)  For example: <a href="https://www.youtube.com/watch?v=hK5liuZSLwY">https://www.youtube.com/watch?v=hK5liuZSLwY</a>	Example of 'assembly manual' from a prefab panel supplier	1 short video example	
3	Loading the partial BIM model onto a tablet or smartphone, showing the specific parts of the façade including the panels	Loading BIM model of Cologne case onto iPad; viewing the relevant building parts or components	Recorded software demonstration of this activity	DEMO (Richard)
4	Installation process of the façade panels of the new storey (rooftop extension)	Animation of the panel installation using BIM of Cologne case, similar to the insulation panel installation at the 'refrigerator'	Short animation	FHG-IPA
<i>Work-in-progress</i>				
5	Construction workers assembling the prefab panels on-site  For example: <a href="https://www.youtube.com/watch?v=fOOHcuWIRs">https://www.youtube.com/watch?v=fOOHcuWIRs</a>	An example of an existing video about prefab panel assembly on-site	Short video example, for instance	3L

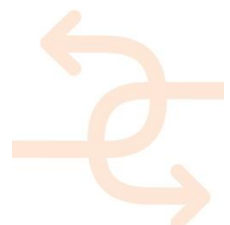

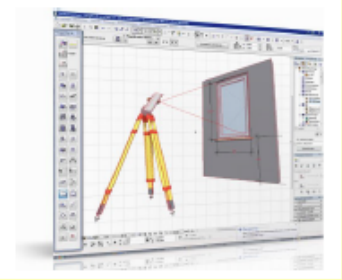
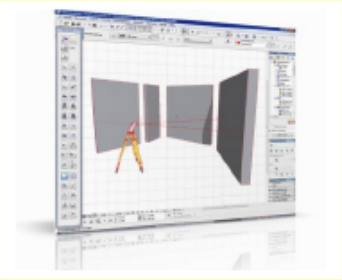
<i>Self-inspection at the level of building component</i>				
6	Check whether the panels are 'perfectly' aligned; check the gaps between panels and at the joints panels and floor slabs	Use of laser measuring / alignment tool. <i>Remark from Giuseppe (UNIVPM): We don't have available the 3D laser scanner, If CARTIF wants to send the equipment there are no problems for us otherwise CARTIF could be produce a demo on CARTIF-3 Building</i>	If the device is available at UNIVPM, then demonstrate in lab; if not, then 1-2 presentation slides or a short movie.	UNIVPM, CARTIF
<p>For example: <a href="https://www.youtube.com/watch?v=14RAH9UTDEY">https://www.youtube.com/watch?v=14RAH9UTDEY</a> or <a href="http://www.stramien.nl/sites.php?fb=fb_news_showitem&amp;sid=22">http://www.stramien.nl/sites.php?fb=fb_news_showitem&amp;sid=22</a> or <a href="http://www.flexijet.info/en/products/flexijet-4architects/the-flexijet-4architects/">http://www.flexijet.info/en/products/flexijet-4architects/the-flexijet-4architects/</a></p> <div style="display: flex; justify-content: space-around;">   </div>				
7	Insert the measured values in the software, and store this data	Show this functionality / feature in the WP3 software	Recorded software demonstration of this activity ; if not possible, then 1 presentation slide showing the proposed software feature with 'mock-up screenshots'	DEMO (Richard)
8	Check if the measured values (i.e. the sizes of the gaps) are acceptable (within the tolerance) for: <ul style="list-style-type: none"> <li>- individual gaps between panels</li> <li>- cumulative gaps in the case of a series of panels</li> </ul>	Show this functionality / feature in the WP3 software (e.g. validation of measured values against 'range limits' or 'threshold limits')	1 presentation slide showing the proposed software feature with 'mock-up screenshots'	DEMO (Richard)
9	Approval and decision-making supported by the software	Show functionality included in the WP3 software <ul style="list-style-type: none"> <li>- If the 'validation' is OK, then self-approval by workers</li> <li>- If the 'validation' is not OK, then send an inquiry to the site supervisor</li> </ul>	1-2 presentation slides showing the proposed software feature with 'mock-up screenshots'	DEMO (Richard)
<i>Iteration of the work (steps 5 – 9) until all panels are placed, and the façade is completed (closed façade)</i>				

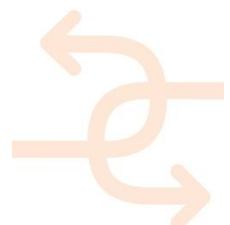

<i>Self-inspection at the level of room or building section</i>				
10	Measurement of the thermal performance (thermal transmittance) of the façade	Measure the actual U-value of a part of the façade after on-site assembly	Real demonstration of the use of thermal measurement device on the panel of the 'refrigerator' in UNIVPM lab	UNIVPM
11	Insert the measured values in the software, and store this data	Show functionality included in the WP3 software	1-2 presentation slides showing the proposed software feature with 'mock-up screenshots'	DEMO (Richard)
12	Check if the measured values are acceptable	Show this functionality / feature in the WP3 software (e.g. validation of measured values against 'range limits' or 'threshold limits')	1-2 presentation slides showing the proposed software feature with 'mock-up screenshots'	DEMO (Richard)
13	Approval and decision-making supported by the software	Show functionality included in the WP3 software <ul style="list-style-type: none"> <li>- If the 'validation' is OK, then self-approval by workers</li> <li>- If the 'validation' is not OK, then send an inquiry to the site supervisor</li> </ul>	1-2 presentation slides showing the proposed software feature with 'mock-up screenshots'	DEMO (Richard)
14	Update of the BIM model >> creation of "as-built BIM"	Generating an updated BIM model that contains measured data, including geometric revisions in case of discrepancies between design and assembly	1-2 presentation slides showing our proposed solution	HVC
15	Generation of a list of adjusted objects or specifications based on the comparison between "pre-built BIM" and "as-built BIM"	Model checking and versioning	1-2 presentation slides or a recorded software demonstration of BIM comparison / versioning	HVC

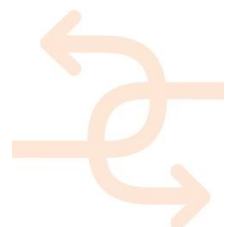

**ACTION 1: CHECKING THE PANELS DELIVERED ON BUILDING SITE  
(ON-SITE PREPARATION)**

- Scan RFID and QR in prefab elements before moving
- Retrieval of component's ID in BIM



11

**ACTION 1: CHECKING THE PANELS DELIVERED ON BUILDING SITE  
(ON-SITE PREPARATION)**

Process Sub-Step	System	Description	Output / Follow-Up Actions
1	CAD	Creation of BIM Model: - Overall Project Model with Attribute about reference to specific panel version - Detail Model of specific panel linked to Project model	Export BIM Modell to IFC
2	SharePoint	Upload IFC-Model to SharePoint and initiate Workflow  <i>Required to</i> - initiate Workflow and - enable version tracking (History of Models) and - do version comparison)	Workflow: -> Copy models to BIM Server -> Prepare PostGre SQL according to BIM Elements' GUIDs -> Generate QR-Code from GUIDs -> Request upload of Design documents automatically -> Order required Panels from Factory
3	Factory	Pre-Fabrication of Panel Retrieve QR Code from SharePoint when ready to deliver	When retrieving the QR Code Sharepoint requests required production documents
4	On Site	Delivery of Prefabricated Panel with attached QR Code Scan QR Code with tablet	Software-Interface Options: - Retrieve Detail Model - Retrieve Overview Model with BCF-Viewpoint - Retrieve Documents (Design & Production) - Check: Comparison of Delivery and Design
5	Software Check	Compare delivered Panel Information and Design Information	Results: 1. OK -> Approval / Continue 2. Mismatch -> Forward Information to Project Manager for Decision Making a) Approval from PM -> Continue b) Denial from PM -> further Decisions

12

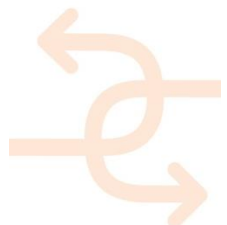

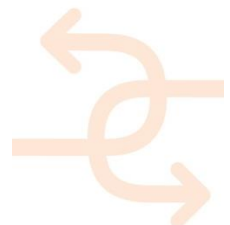
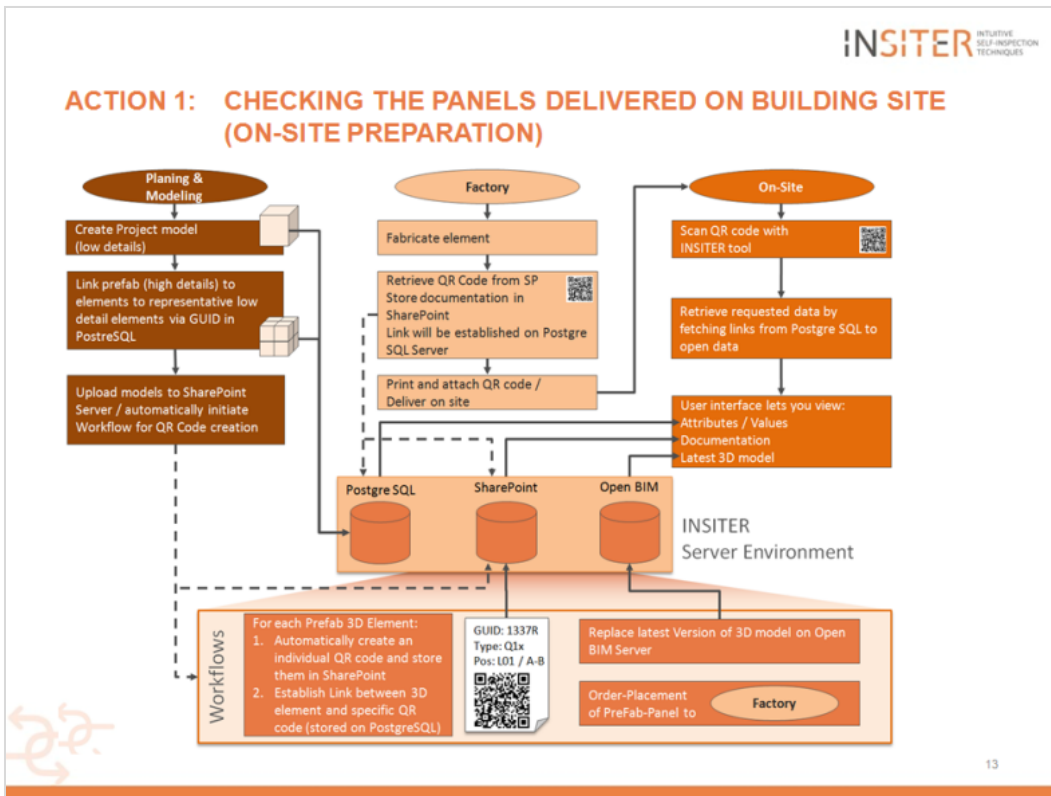

**ACTION 3: LOADING BIM MODEL ONTO TABLET  
VIEWING THE RELEVANT COMPONENTS ON DISPLAY  
(SELF-INSTRUCTION)**



15

**ACTION 4: INSTALLATION PROCESS OF THE FAÇADE PANELS  
(SELF-INSTRUCTION)**



16

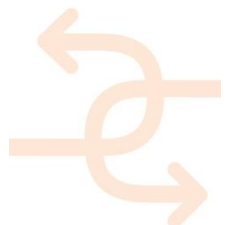



**ACTION 5: CONSTRUCTION WORKERS ASSEMBLING THE PREFAB  
PANELS ON SITE  
(WORK IN PROGRESS)**



17

**ACTION 6: CHECK PERFECT ALIGNMENT  
(SELF-INSPECTION AT COMPONENT LEVEL)**

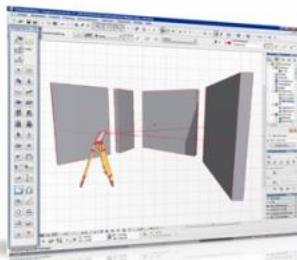

18

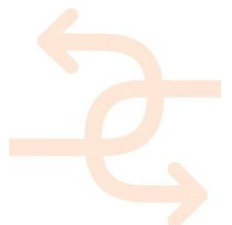

**ACTION 7: INSERT AND STORE THE MEASURED VALUES IN SOFTWARE  
(SELF-INSPECTION AT COMPONENT LEVEL)  
REGISTER MEASUREMENTS ON THE TABLET**

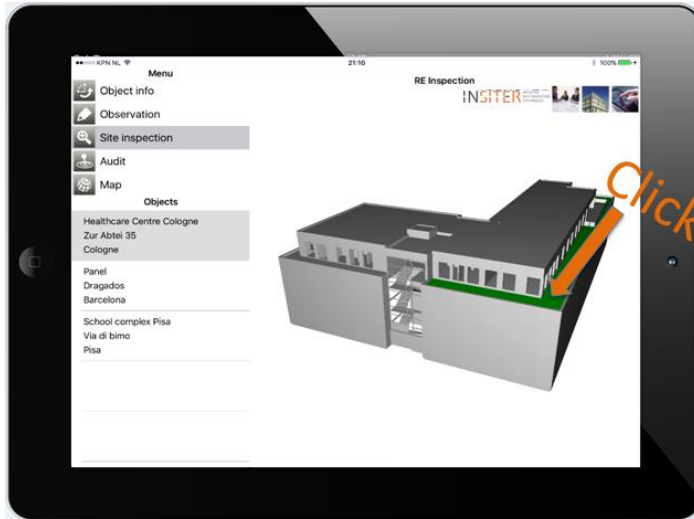

19

**ACTION 7: INSERT AND STORE THE MEASURED VALUES IN SOFTWARE  
(SELF-INSPECTION AT COMPONENT LEVEL)  
PERFORM A SITE INSPECTION**

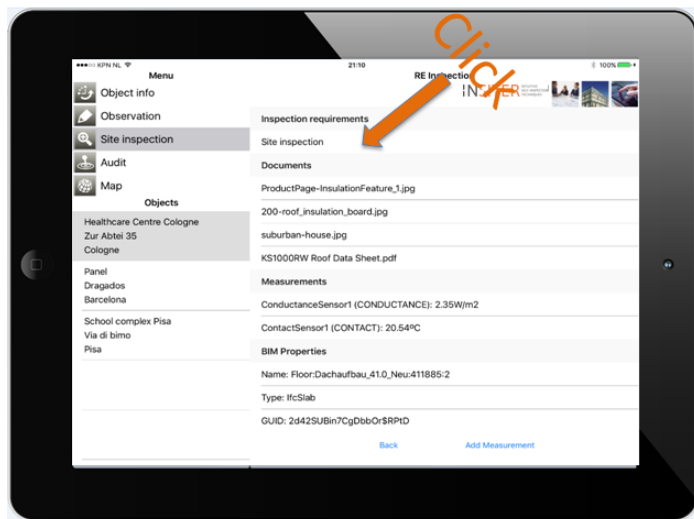

20

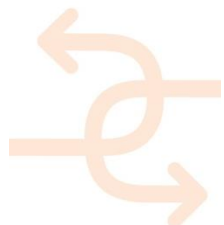

**ACTION 7: INSERT AND STORE THE MEASURED VALUES IN SOFTWARE  
(SELF-INSPECTION AT COMPONENT LEVEL)  
FILL IN THE SELF INSPECTION CHECKLIST**

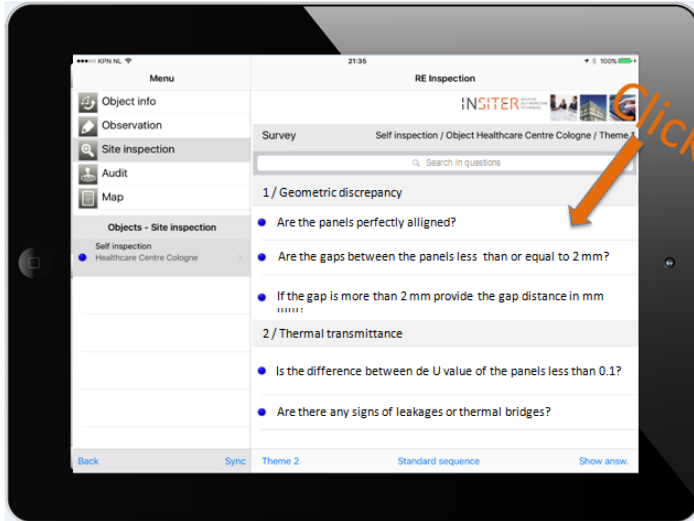

21

**ACTION 7: INSERT AND STORE THE MEASURED VALUES IN SOFTWARE  
(SELF-INSPECTION AT COMPONENT LEVEL)  
PROVIDE THE ANSWERS (CAN ALSO BE A VALUE)**

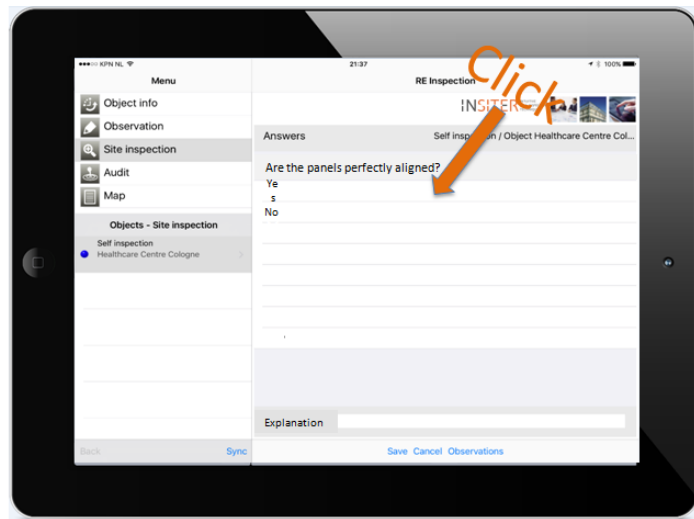

22

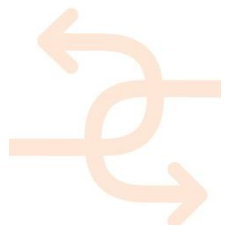

**ACTION 8, 9: CHECK AND APPROVAL OF MEASURED VALUES  
(SELF-INSPECTION AT COMPONENT LEVEL)  
TAKE DECISIONS BASED ON KPI'S**



**ACTION 8, 9: CHECK AND APPROVAL OF MEASURED VALUES  
(SELF-INSPECTION AT COMPONENT LEVEL)  
EXAMPLE FLEXIJET**

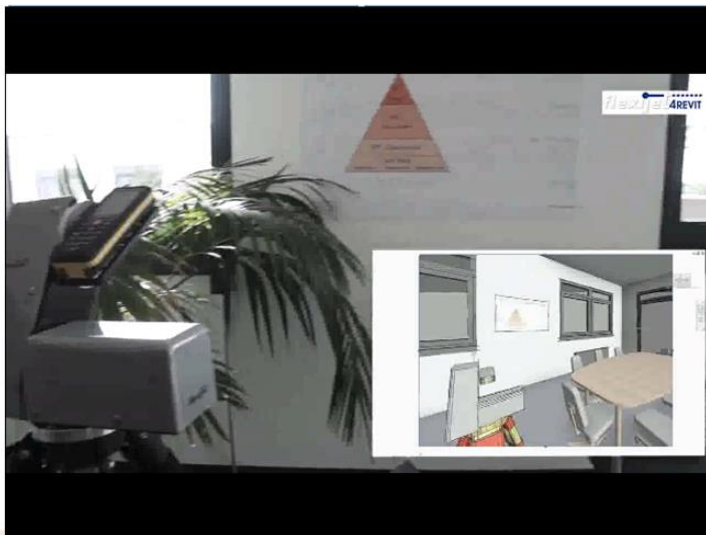

**ACTION 8, 9: CHECK AND APPROVAL OF MEASURED VALUES  
(SELF-INSPECTION AT COMPONENT LEVEL)  
EXAMPLE CARTIF**

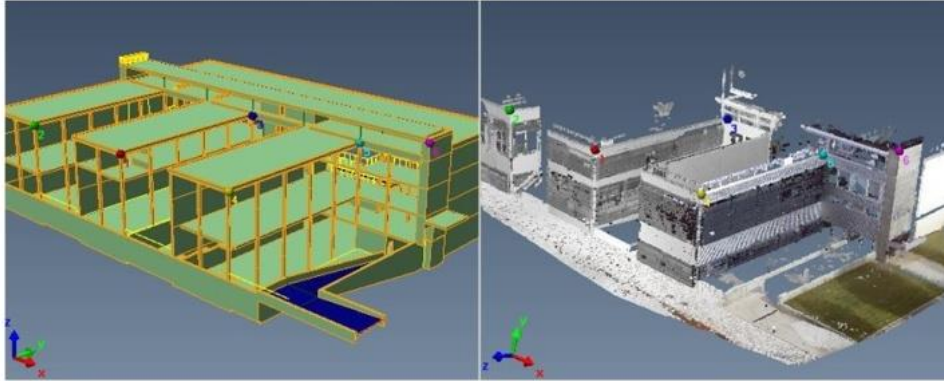

*BIM Model*

*3D laser scan*



**ACTION 8, 9: CHECK AND APPROVAL OF MEASURED VALUES  
(SELF-INSPECTION AT COMPONENT LEVEL)  
EXAMPLE CARTIF**

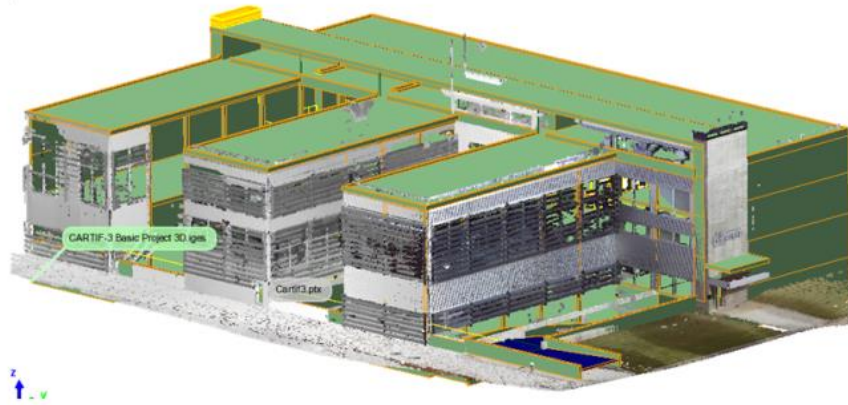

*Junction BIM Model & 3D laser scan*

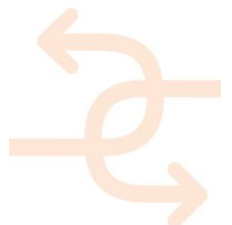

**ACTION 8, 9: CHECK AND APPROVAL OF MEASURED VALUES  
(SELF-INSPECTION AT COMPONENT LEVEL)  
EXAMPLE CARTIF**

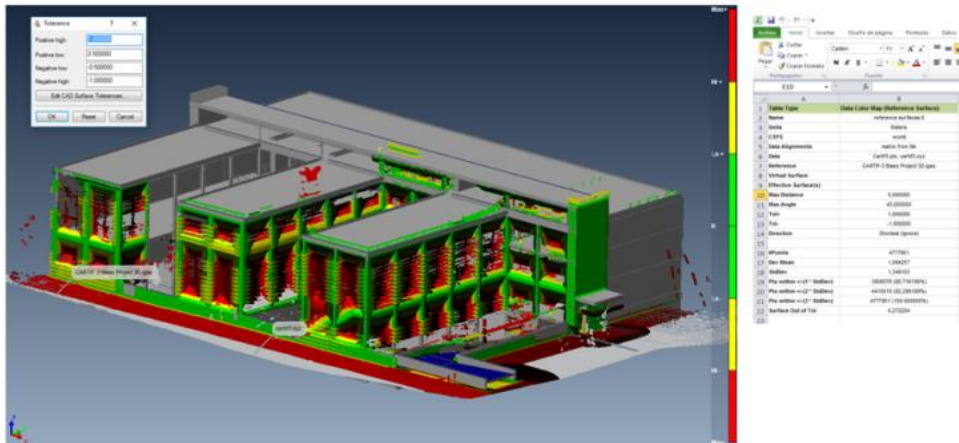

Quantify and qualify deviations BIM Model & 3D laser scan

28

**ACTION 10: MEASUREMENT OF THERMAL PERFORMANCE OF FACADE  
(SELF-INSPECTION AT COMPONENT LEVEL)  
IN SITU THERMAL TRANSMITTANCE EVALUATION**

- Experimental procedure steps
  1. TEST SET-UP with prefabricated panel installed in a mock-up
  2. Thermal test
  3. Thermal transmittance evaluation



29

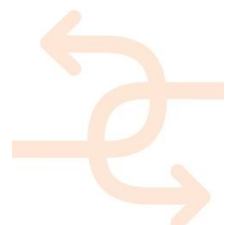

**ACTION 10: MEASUREMENT OF THERMAL PERFORMANCE OF FACADE  
(SELF-INSPECTION AT COMPONENT LEVEL)**

**1. SET-UP: THERMAL CAMERA INSTALLATION**

- 1. Set the correct distance from the wall surface. The field of view must guarantee the inspection of the region of interest with the spatial resolution required for the accurate reconstruction of small objects in the image (as thin thermal bridges)
- 2. Calibrate the sensor for temperature reading. The surface emissivity and reflected temperature must be evaluated; environmental humidity and temperature must be measured



Emissivity reference

Thermal hygrometer

Aluminium foil for reflected temperature calculation

30



**ACTION 10: MEASUREMENT OF THERMAL PERFORMANCE OF FACADE  
(SELF-INSPECTION AT COMPONENT LEVEL)**

**1. SET-UP: THERMOCOUPLE+HEATFLUX METER INSTALL.**

- Identification of sensor position:
  - Far from regions affected by thermal bridges or areas where thermal flow is not mono-directional (those regions can be potentially identified by thermography)
  - Far from areas under the direct influence of either a heating or a cooling device

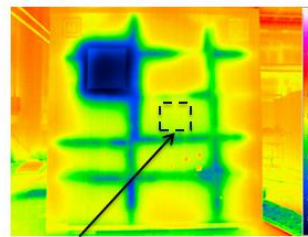

Potential sound area

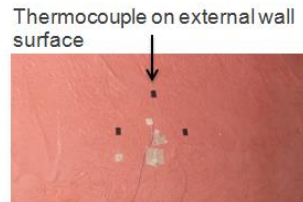
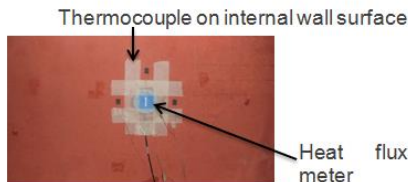

31

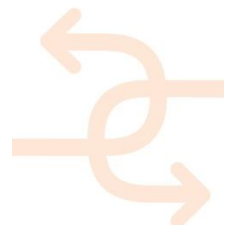

**ACTION 10: MEASUREMENT OF THERMAL PERFORMANCE OF FACADE (SELF-INSPECTION AT COMPONENT LEVEL)**  
**2. THERMAL TEST**

- The refrigerator room must be thermally conditioned and controlled in order to generate thermal gradients between the interior and exterior wall surface

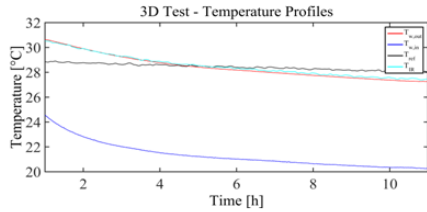

$T_{win}$ : Indoor surface temperature  
 $T_{w,out}$ : Outdoor surface temperature  
 $T_{IR}$ : IR sensor temperature  
 $T_{ref}$ : Reflected temperature

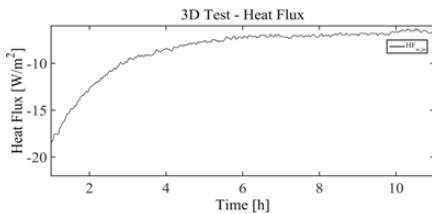

$HF_{win}$ : thermal heat flux measured on the internal wall surface

32

**ACTION 10: MEASUREMENT OF THERMAL PERFORMANCE OF FACADE (SELF-INSPECTION AT COMPONENT LEVEL)**  
**2. THERMAL TEST**

- The Soft-Sensing approach based on IR thermal camera allows to reduce the time of inspection

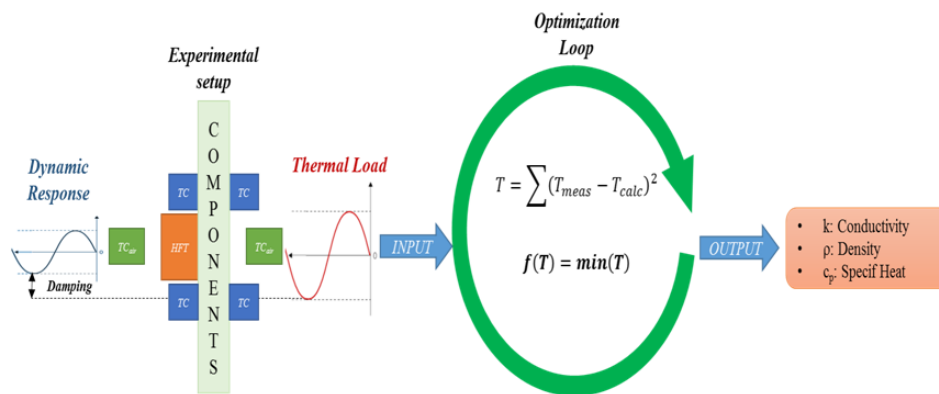

33





**ACTION 10: MEASUREMENT OF THERMAL PERFORMANCE OF FACADE  
(SELF-INSPECTION AT COMPONENT LEVEL)  
3. THERMAL TRANSMITTANCE EVALUATION**

Thermal transmittance calculated from the heat flux and from temperature gradients using IR thermal camera

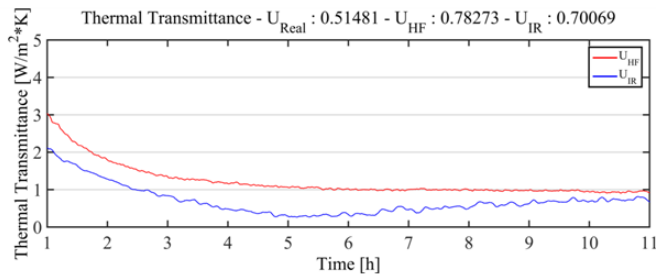

- Thermal transmittance calculated from the heat flux: 0.78 W/m<sup>2</sup>K
- Thermal transmittance calculated from temperature gradients using IR thermal camera: 0.70 W/m<sup>2</sup>K
- Thermal transmittance calculated by applying soft-sensing approach : 0.51 W/m<sup>2</sup>K
- Thermal transmittance reference value (supplied by DRAGADOS): 0.51 W/m<sup>2</sup>

**ACTION 11: INSERT + STORE THE MEASURED VALUES IN THE SOFTWARE  
FILL IN THE SELF INSPECTION CHECKLIST**

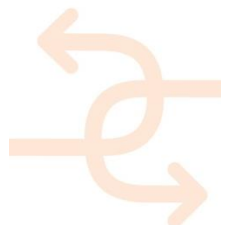

**ACTION 11: INSERT + STORE THE MEASURED VALUES IN THE SOFTWARE  
PROVIDE THE ANSWERS (CAN ALSO BE A VALUE)**

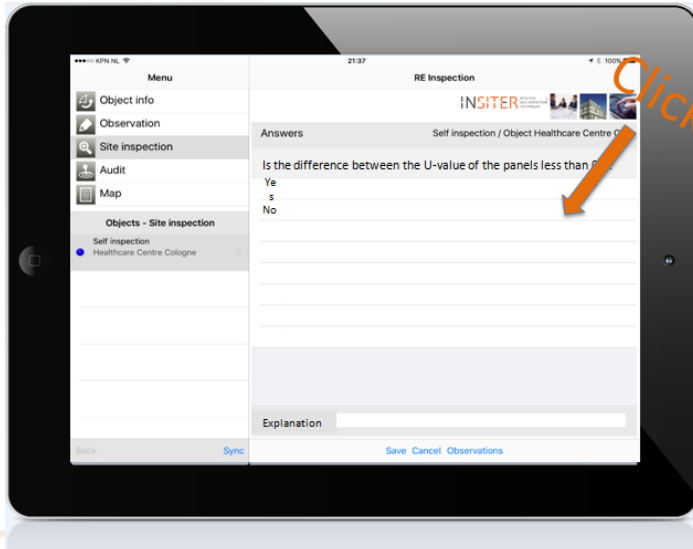

36

**ACTION 12, 13: CHECK AND APPROVE ACCEPTABILITY OF MEASURED  
VALUES BASED ON KPI'S, DECISION MAKING**



37



**ACTION 14: UPDATE OF BIM MODEL (AS BUILT BIM)  
(SELF-INSPECTION AT ROOM LEVEL)**

Process Sub-Step	System	Description	Output / Follow-Up Actions
1	Change Request System	Site-Supervisor receives list of inquiries and evaluates the impact: - on-site changes are ignorable -> OK - Changes have to be adjusted -> Change Request	Issue of Change Request will be created in Change Request DB (part of Postgre SQL Server)
2	Change Request System	Site-Supervisor quantifies the kind of Change Request: - Minor Change (e.g. very small geometrical differences) -> to be adjusted via As-Built attribute information - Major Change (e.g. missing wall element) -> model has to be updated to represent as-built	Change Request Report: Quantified list of change requests will be forwarded to BIM modeller
3	CAD	BIM Modeller evaluates Change Request Report and incorporates changes in latest BIM model: - Minor changes: -> just listed as as-built attributes - Major changes: -> revising the model	All issues are revised in As-Built BIM model -> export to IFC
4	Model Check System	Perform model check of latest BIM model to guarantee full consistency with existing data	Model Check Report: - Errors: perform update (continue at 3) - No errors: As-Built model finalized
5	SharePoint	Upload updated As-Built model to Sharepoint Server	Initiated automatically Workflow: - Update status in Change Request DB - Update latest model on Open BIM Server - Inform all participants

38

**ACTION 14: UPDATE OF BIM MODEL (AS BUILT BIM)  
(SELF-INSPECTION AT ROOM LEVEL)**

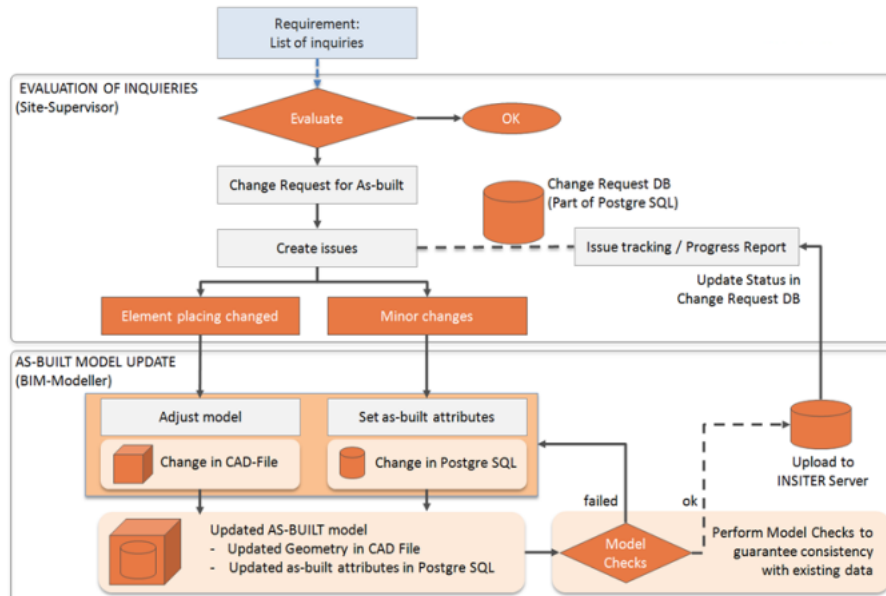

39

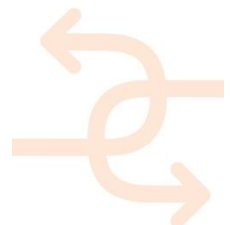

**ACTION 15: GENERATION OF ADJUSTED OBJECTS' LIST  
(SELF-INSPECTION AT ROOM LEVEL)**

Process Sub-Step	System	Description	Output / Follow-Up Actions
1	Sharepoint	BIM-Modeller checks the availability of the "Design BIM"-model and the "As-Built BIM"-model  In case those files are not available to the BIM-modeler: Download both versions of the model from SharePoint.	"Design BIM"-model and "As-Built BIM"-model are available to the BIM-Modeller.
2	Desite MD	Preparing the Version comparison: 1. Load "Design BIM"-model, 2. Start version checking tool and 3. Add "As-Built BIM"-model.	Models now are integrated to the Version Checking Tool
3	Desite MD	Decision which information should be compared: - Geometry: dimensions of elements, - Coordinates: position of elements - Attributes: attributes itself and values of attributes	Colored model, showing the changes: - new elements - changed elements - deleted elements
4	Desite MD	Generation of a list of adjusted objects or specifications based on the comparison between "pre-built BIM" and "as-built BIM"	Generated report as excel or pdf document or stored in a database. Will be uploaded to INSITER Server
5	SharePoint	Upload of report on share point to show all participants	



**ACTION 15: GENERATION OF ADJUSTED OBJECTS' LIST  
(SELF-INSPECTION AT ROOM LEVEL)**

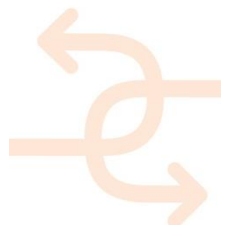
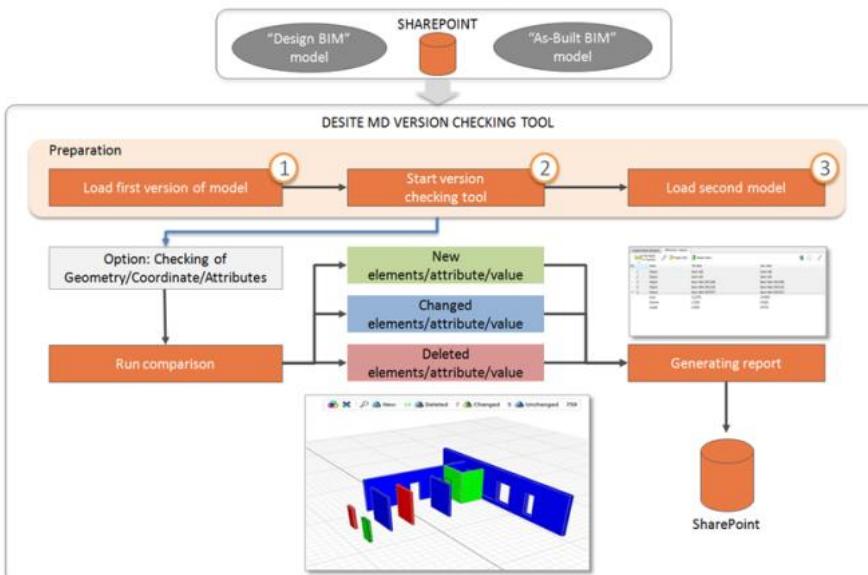

## 10. APPENDIX 2 – Storyboard 2

30 November 2016  
Ancona meeting

# STORYBOARD 2: JOINTS AND CRITICAL INSULATIONS AT CONNECTION BETWEEN THE ORIGINAL ROOF AND NEW FAÇADE PANELS



**INSITER** INTUITIVE  
SELF-INSPECTION  
TECHNIQUES

**INSITER** INTUITIVE  
SELF-INSPECTION  
TECHNIQUES

### DEMO CASE COLOGNE

Situation

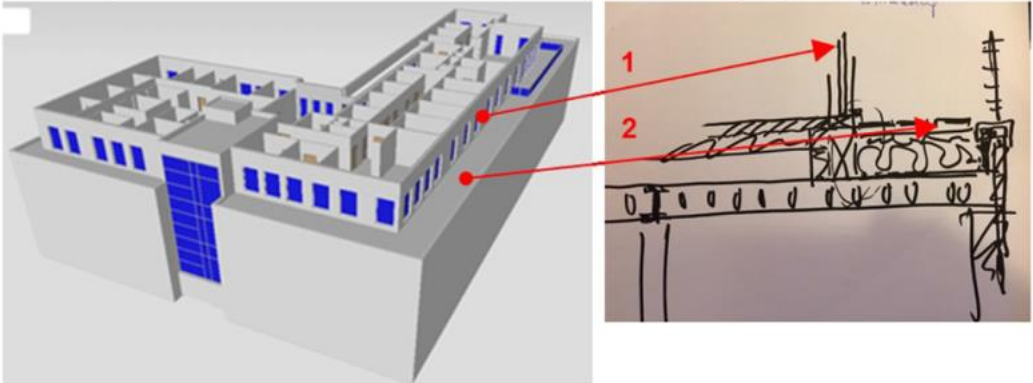

13 February 2017

INSITER KICK-OFF

2

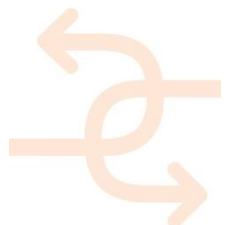

## EXPERIENCED ROOFER

We assume that we deal with an experienced roofer.

But we want to make sure that critical elements get extra attention by self-instruction and self-inspection

With the help of BIM-system / software for self instruction / self-inspection



DAKDEKKER



13 February 2017

INSITER KICK-OFF

3

## CRITICAL ELEMENTS

1. Right material
2. Right handling and storage
3. Safety
4. Inspection of starting situation
5. Technical details
  - Connection vapour layer to concrete
  - Connection layers + insulation to prefab wall panel
  - Connection layers + insulation to edge old building
  - Gaps between insulation boards and between boards and connections to vertical elements.
  - Watertight rainwater discharge
  - Right slope (no rainwater accumulation on roof)
  - Watertight finishing
  - Careful placing of the tiles

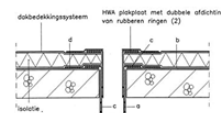
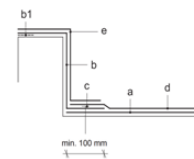
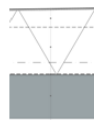

13 February 2017

INSITER KICK-OFF

4

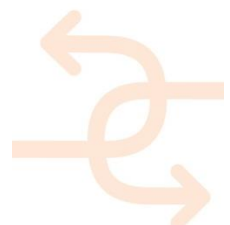

### 1. CHECK OF RIGHT MATERIAL

Self inspection on product quality

- Vapour resistant layer e.g. a bitumen layer
- Insulation e.g. mineral wool
- Fixing material
- Roof finishing / membrane
- Promenade slabs on paving slabs supports

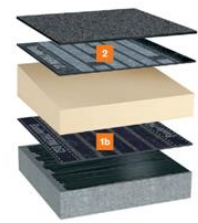

13 February 2017

INSITER KICK-OFF

5

### CHECKLIST (E.G. INSULATION MATERIAL MINERAL WOOL)

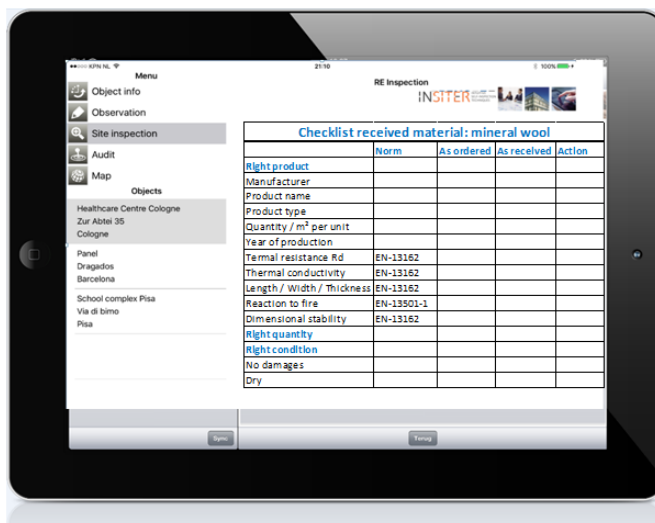

13 February 2017

INSITER KICK-OFF

6

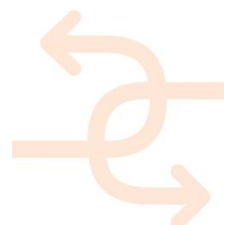

## 2. HANDLING & STORAGE GUIDELINES

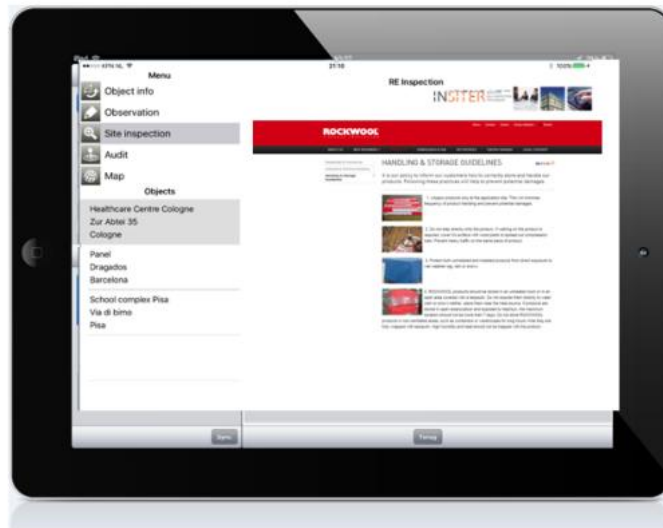

13 February 2017

INSITER KICK-OFF

7

## 3. SAFETY INSTRUCTIONS AND BUILDING SITE REGULATIONS

- Be sure that all the staff knows the safety instructions for working at heights
  - In general
  - Specific for the job
- Be sure that all the staff knows the safety instructions for working with open fire
- Be sure that all the staff knows the specific building site regulations (hospital)

13 February 2017

INSITER KICK-OFF

8





**SAFETY INSTRUCTIONS AND BUILDING SITE REGULATIONS**



13 February 2017

INSITER KICK-OFF

9

**4. INSPECTION OF THE STARTING SITUATION**

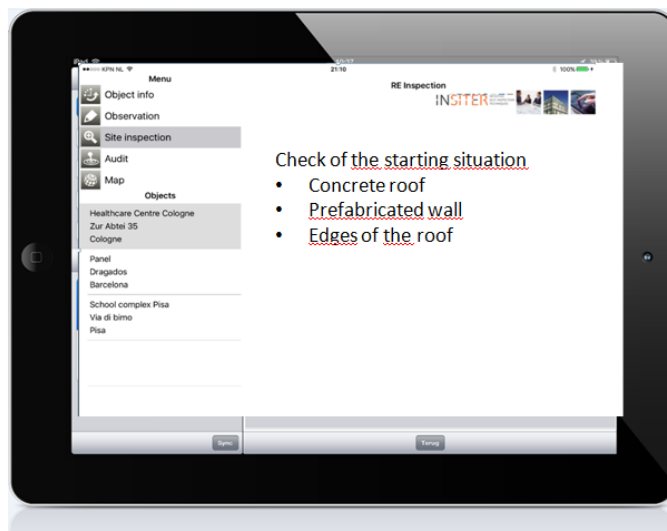

13 February 2017

INSITER KICK-OFF

10

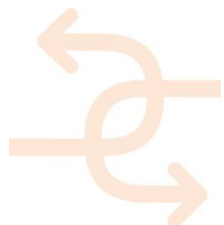

#### 4. INSPECTION OF THE STARTING SITUATION

Proof the condition of the concrete roof

- Flat (tolerances less than 5mm/m1)
- Not damaged
- Dry (< humidity 18 volume % depending on the layer)
- Clean
- No cables, ducts etc.

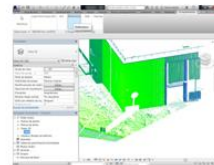

How:

- Visual with photo as proof
- Check of humidity of roof (visual) and with 3D laser scanning
- Check flatness of roof by 3D laser scanning



13 February 2017

INSITER KICK-OFF

11

#### PERFORM SITE INSPECTION

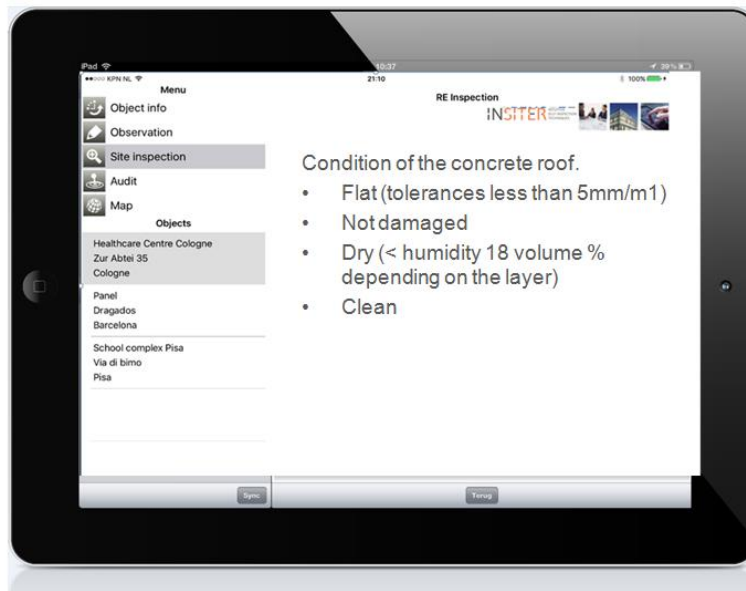

13 February 2017

12

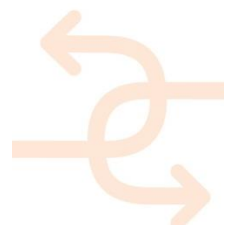

**FILL IN THE INSPECTION CHECKLIST**

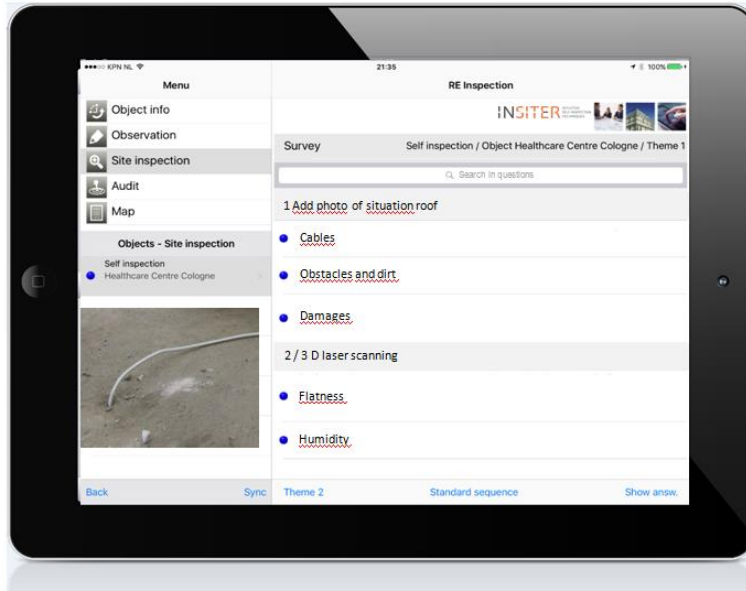

13 February 2017

13

**PROVIDE THE ANSWERS (CAN ALSO BE A VALUE)**

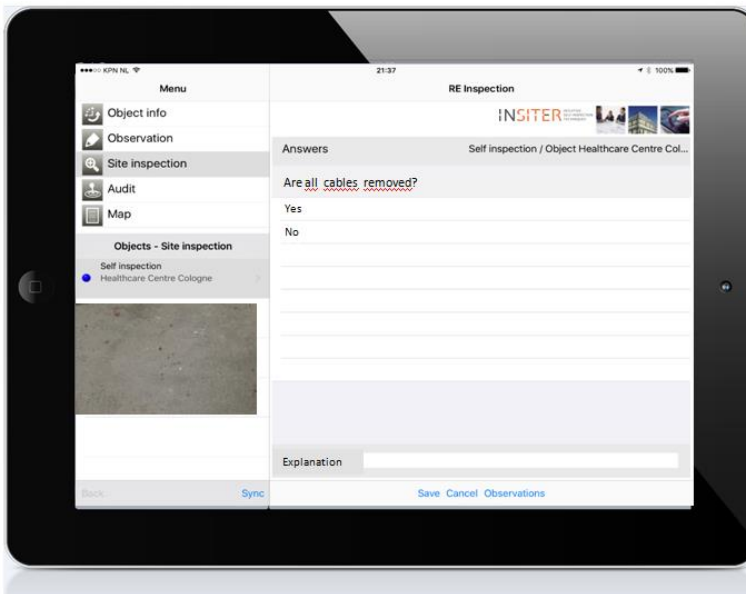

13 February 2017

14

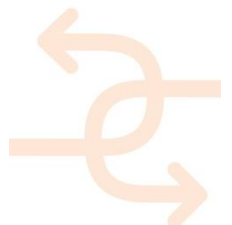

## 5. TECHNICAL DETAILS

In advanced we determined the critical technical details. This critical technical details have to be available for self instruction and self inspection

- Connection vapour layer to concrete
- Connection layers + insulation to prefab wall panel
- Connection layers + insulation to edge old building
- Gaps between insulation boards and between boards and connections to vertical elements.
- Watertight rainwater discharge
- Right slope (no rainwater accumulation on roof)
- Watertight finishing
- Careful placing of the tiles



13 February 2017

M18 REVIEW MEETING

15

## DETAILED INFORMATION

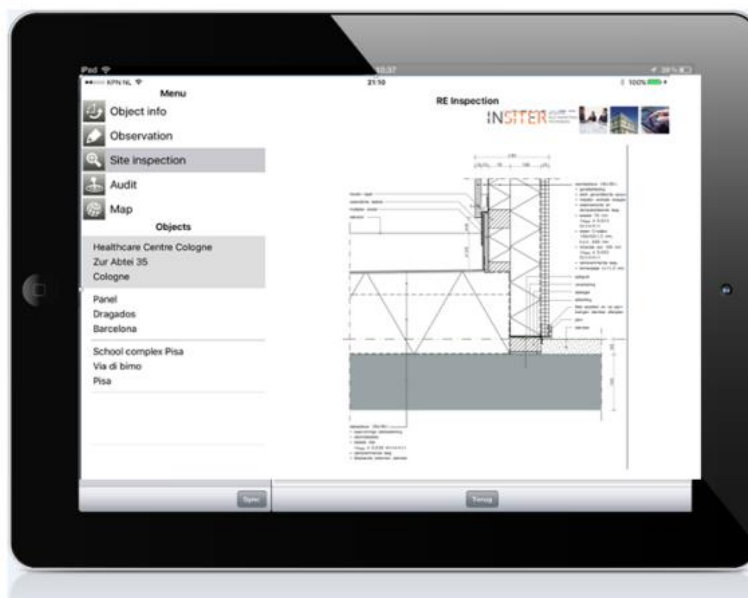

13 February 2017

16

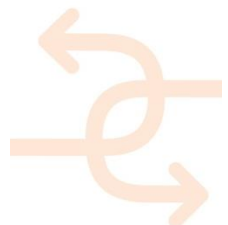

**LINK TO FURTHER INFORMATION (DETAIL, BUILDING PHYSICS, DESIGN AND REALISATION)**

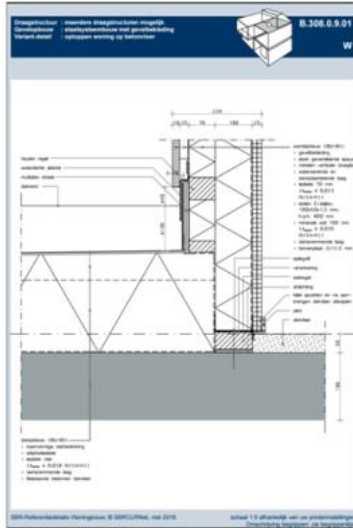

13 February 2017

M18 REVIEW MEETING

17

**DETAILED INFORMATION INSTALLATION PROCESS**

- The vapour layer is glued to the concrete floor and edge of the building and set up against the prefab facade element



- The insulation layer exists of two layer (flat layer and slope)



- The roof finishing / membrane is set up against concrete edge and prefab facade element

13 February 2017

INSITER KICK-OFF

18

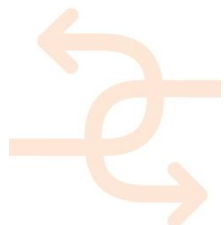

## INSTALLATION PROCESS

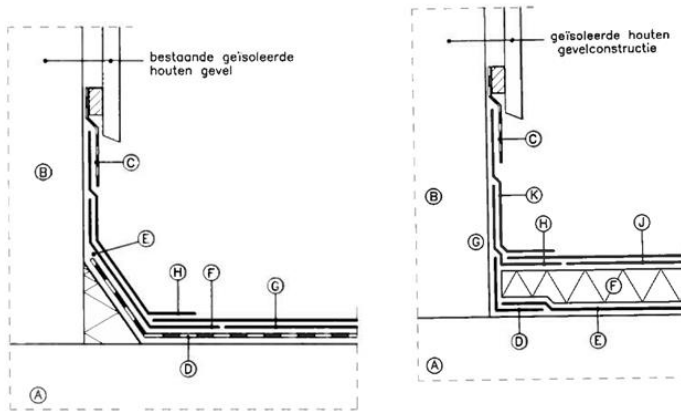

Source BDA

13 February 2017

INSITER KICK-OFF

19

## ASSEMBLY OF FINISHING LAYER



### Werkwijze:

- a. De eerste laag aanbrengen tot in de kim. De banen kunnen evenwijdig aan of haaks op de opstand worden aangebracht.
  - b. Op deze laag een polymere dakbaan aanbrengen volledig gekleefd met koude bitumen kleefstof of zelfklevend op een (actieve) synthetische primerlaag evenwijdig aan de opstand, minimaal 70 mm opzetten. De kopse overlappen thermisch lassen.
  - c. Van bovenkant opstand (bijvoorbeeld onder voeflood) een zelfklevende polymere randstrook aanbrengen tot minimaal 70 mm door de kim. Het verticale werk voorsmeren met een (actieve) synthetische primer. De overlappen en de aansluiting met baan b. thermisch lassen.
  - d. De top laag van de bitumen dakbedekking aanbrengen volgens de brandmethode tot op minimaal 750 mm afstand van de gevelaansluiting.
- Over deze randstrook het voeflood aanklikken:  
Aanslijpen voeflood:  
- kwaliteit code 20;  
- maximale lengten 1 m;  
- overlappen minimaal 80 mm, het niet uitstekende gedeelte solderen; in geval van renovatie een zogenaamde haaknaad toepassen;  
- het vrijhangende gedeelte moet circa 80 mm bedragen, in ieder geval mag de breedte nooit meer zijn dan de opstandhoogte minus 50 mm.

13 February 2017

INSITER KICK-OFF

20

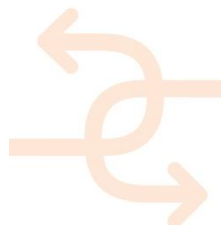

## SELF-INSPECTION QUALITY OF WORK

Proof the correct assembly of every layer:

- Vapour resistant layer e.g. a bitumen layer
- Insulation e.g. mineral wool
- Roof finishing / membrane
- Promenade slabs on paving slabs supports

How:

- Visual with photo as proof



13 February 2017

INSITER KICK-OFF

21

## FILL IN THE SELF INSPECTION CHECKLIST



13 February 2017

22

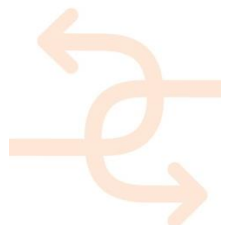

**PROVIDE THE ANSWERS (CAN ALSO BE A VALUE)**

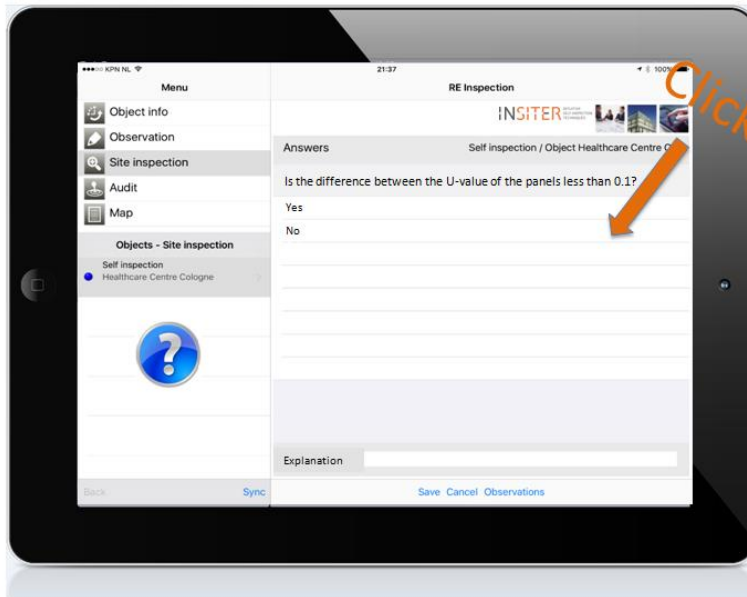

13 February 2017

23

**SUPPORT TO GIVE THE RIGHT ANSWER**



- What are the consequences on average U-value of
  - spaces between insulation boards
  - spaces behind insulation boards
- What is the definition of a gap?

13 February 2017

M18 REVIEW MEETING

24





## KPI'S AND MEASUREMENT TECHNIQUES

As other parts of the building, the roof must be checked for the KPIs with the following measurements:

- Measurement of the airtightness by using a blower door
- Measurement of the airborne sound insulation of the roof
- Measurement of the heat transfer by using a thermal camera.
- Measurement of the humidity by using a 3D laser scanner to detect moisture and water problems.



13 February 2017

M18 REVIEW MEETING

25

## TAKE DECISIONS BASED ON KPI'S



13 February 2017

26

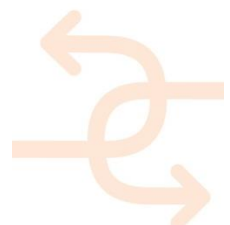

## 11. APPENDIX 3 – Storyboard 3

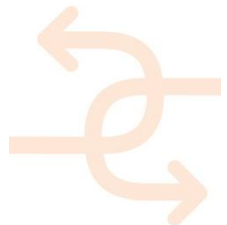

**INSITER** INTUITIVE SELF-INSPECTION TECHNIQUES

**SITE PREPARATION**  
**1- CHECK CORRECTNESS OF THE VENTILATION DUCTS DELIVERED ON BUILDING SITE (QR CODES) AND VISUALLY CHECK OF DAMAGES.**



M18 REVIEW MEETING 3

**INSITER** INTUITIVE SELF-INSPECTION TECHNIQUES

**SELF INSTRUCTION**  
**2- LOADING THE BIM ON A PORTABLE DEVICE AND USE THE 3D DRAWING AS INSTRUCTION.**



13 February 2017 M18 REVIEW MEETING 4

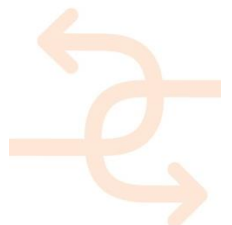

**SELF INSTRUCTION**

**2- LOADING THE BIM ON A PORTABLE DEVICE AND USE THE 3D DRAWING AS INSTRUCTION.**



13 February 2017

M18 REVIEW MEETING

5

**SELF INSTRUCTION**

**3- USE THE OUTDOOR AND INDOOR POSITIONING SYSTEMS TO VERIFY THE CORRECTNESS OF THE ASSEMBLY LOCATION.**

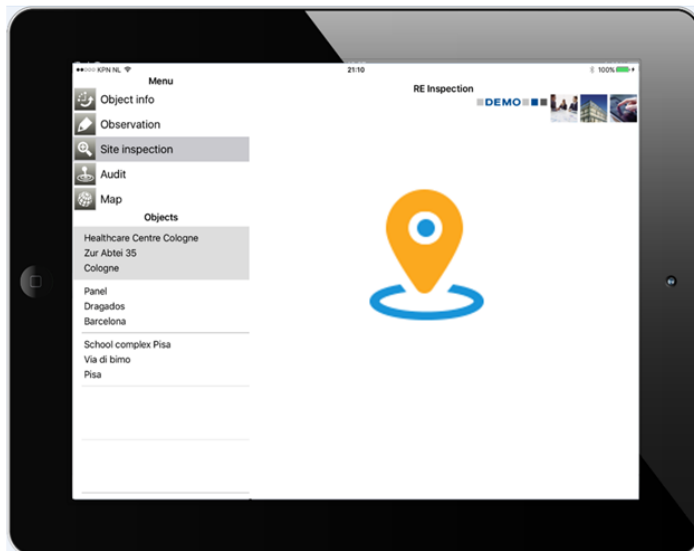

13 February 2017

M18 REVIEW MEETING

6



**SELF INSTRUCTION**

**4- RETRIEVE THE DOCUMENTATION AND INSTALLATION MANUAL OF THE COMPONENTS FROM THE BIM (1)**

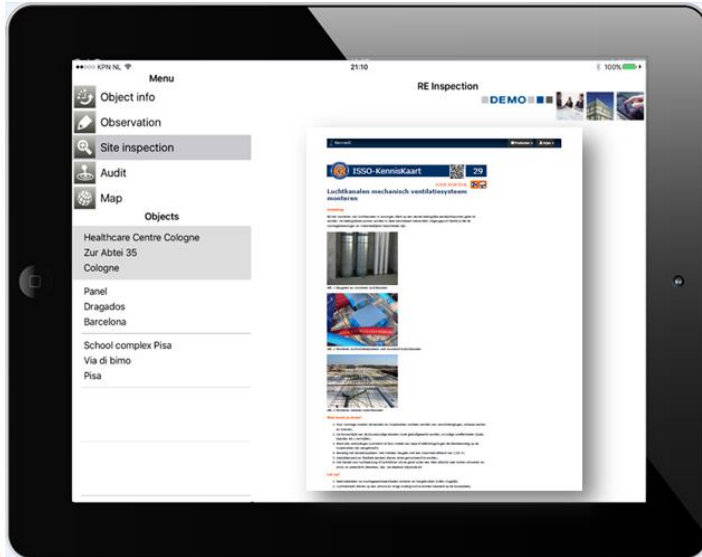

13 February 2017

M18 REVIEW MEETING

7

**SELF INSTRUCTION**

**4- RETRIEVE THE DOCUMENTATION AND INSTALLATION MANUAL OF THE COMPONENTS FROM THE BIM (2)**

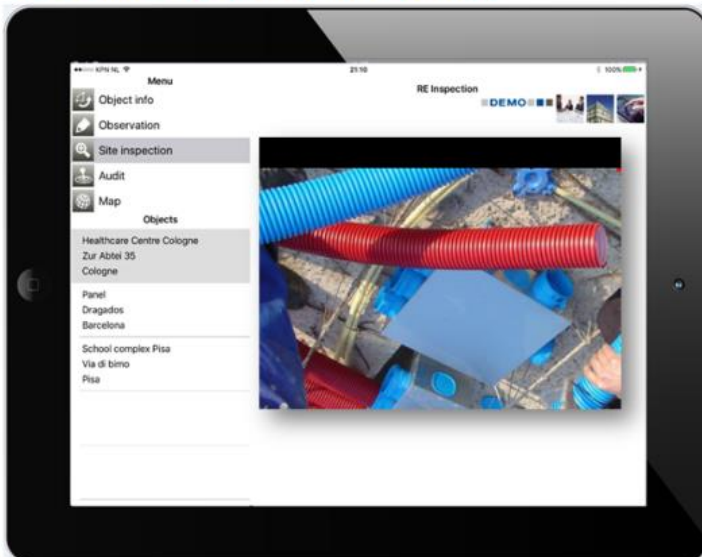

13 February 2017

M18 REVIEW MEETING

8

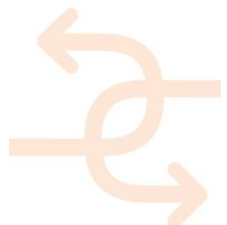

**SELF INSTRUCTION**

**4- RETRIEVE THE DOCUMENTATION AND INSTALLATION MANUAL OF THE COMPONENTS FROM THE BIM (2)**

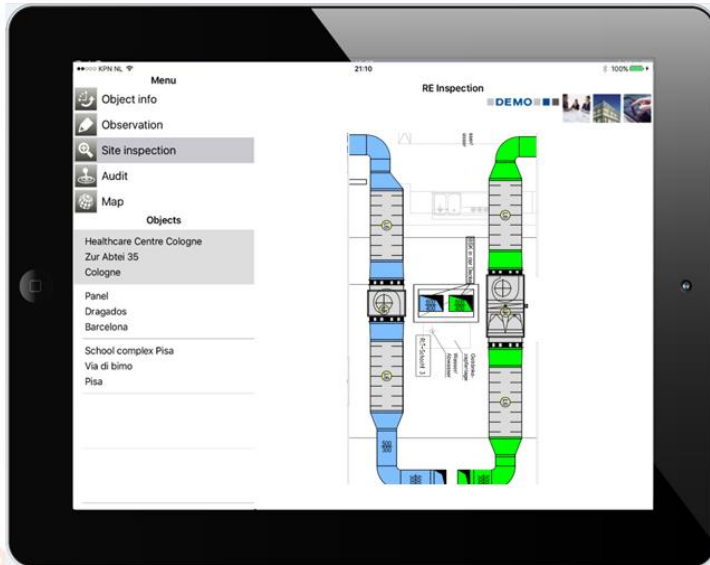

13 February 2017

M18 REVIEW MEETING

9

**WORK IN PROGRESS**

**5- RETRIEVE THE CALCULATED SETTINGS, AND ADMINISTER THIS SETTINGS**

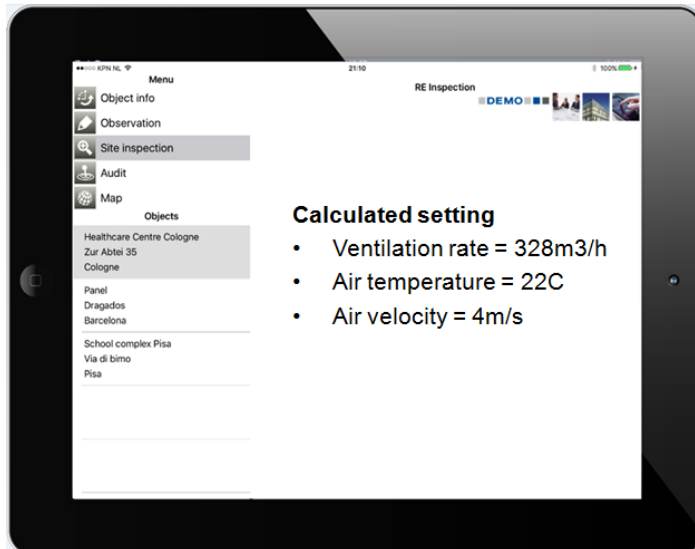

13 February 2017

M18 REVIEW MEETING

10

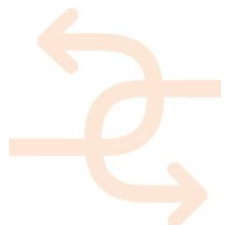

**WORK IN PROGRESS**

**6- RETRIEVE THE CALCULATED SETTINGS, AND ADMINISTER THIS SETTINGS**

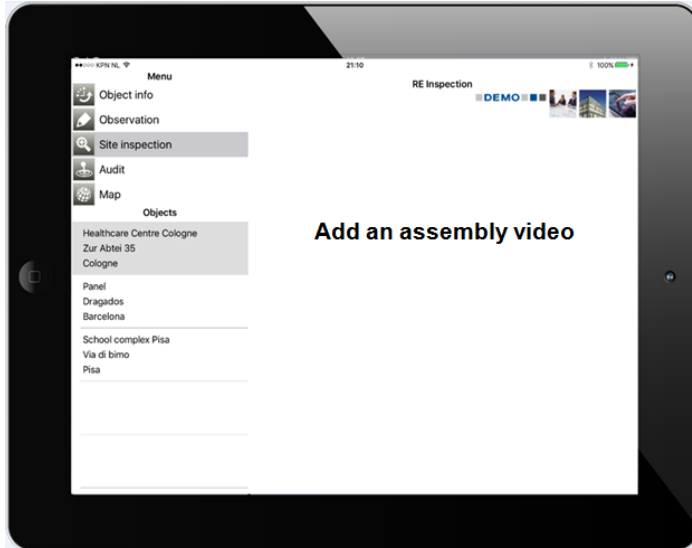

13 February 2017

M18 REVIEW MEETING

11

**SELF-INSPECTION AT THE LEVEL OF COMPONENT**

**7- PROJECT AN OVERLAY OVER INSTALLED COMPONENTS/DUCTING TO VERIFY CORRECT INSTALLATION, COURSE AND LOCATION**

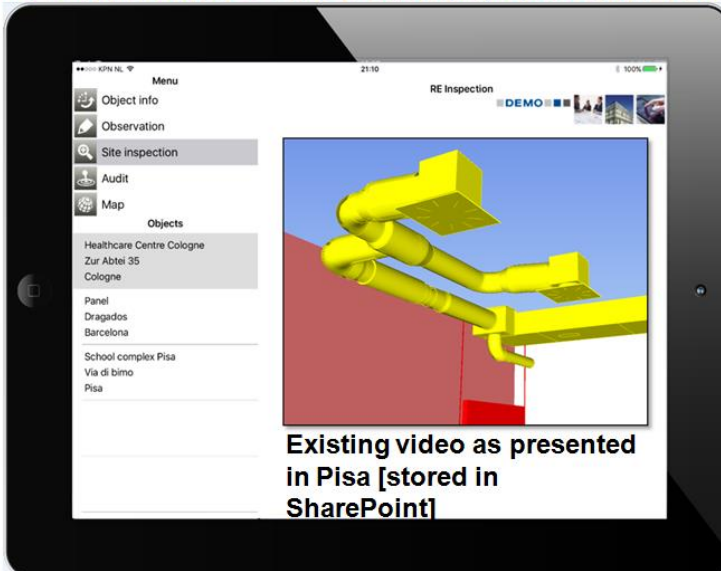

13 February 2017

M18 REVIEW MEETING

12

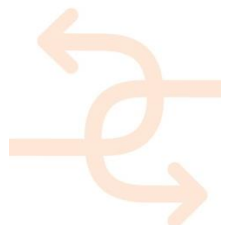

**SELF-INSPECTION AT THE LEVEL OF COMPONENT**  
**8- IN CASE OF FUNCTIONAL TESTING, TEST READINGS/OUTCOMES**  
**SHOULD BE STORED IN A DATABASE/BIM**

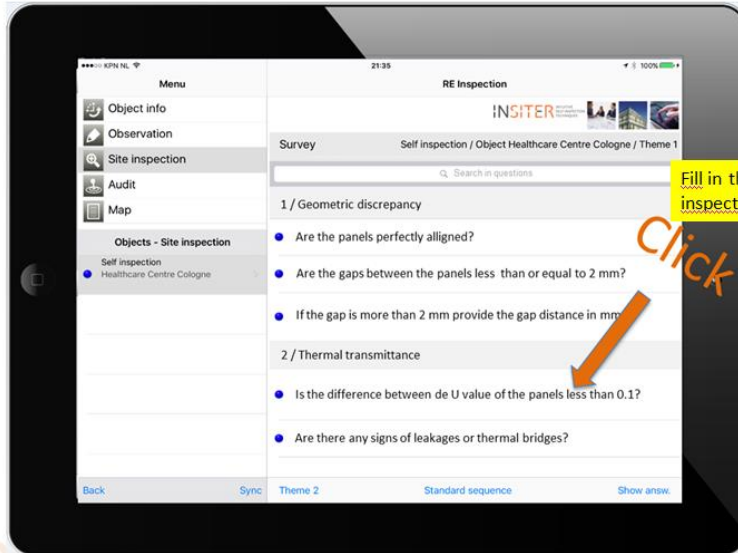

13 February 2017

M18 REVIEW MEETING

13

**SELF-INSPECTION AT THE LEVEL OF COMPONENT**  
**9- IN CASE OF DEVIATIONS, CHECK IF THE MEASURED VALUES ARE**  
**ACCEPTABLE.**

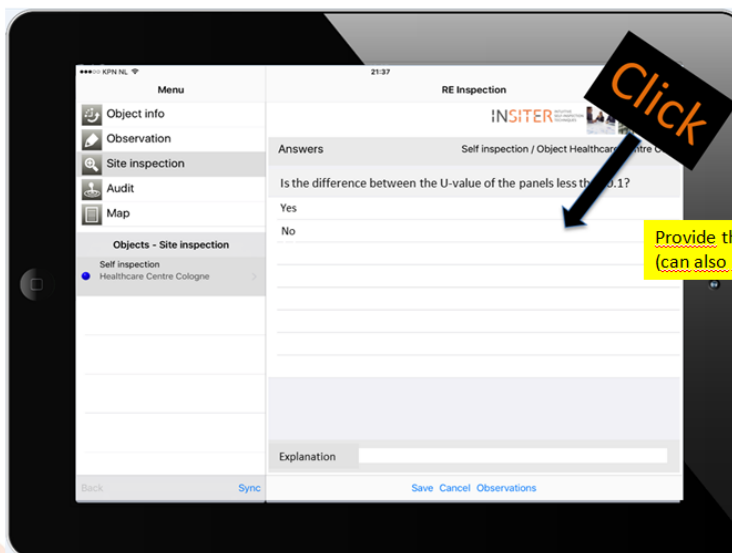

13 February 2017

M18 REVIEW MEETING

14

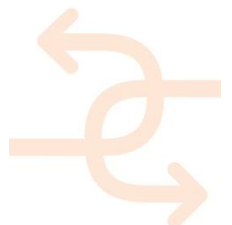



**INSITER** INTUITIVE  
SELF-INSPECTION  
TECHNIQUES

**SELF-INSPECTION AT THE LEVEL OF ROOM OR BUILDING SECTION**  
**10- MEASUREMENT OF CORRECT AIRFLOW THROUGH THE NEW  
DUCTING SECTION**



Source: [http://inspectapedia.com/aircond/Dwyer\\_MVA\\_Airflow\\_Anemometers.jpg](http://inspectapedia.com/aircond/Dwyer_MVA_Airflow_Anemometers.jpg)

13 February 2017

M18 REVIEW MEETING

15

**INSITER** INTUITIVE  
SELF-INSPECTION  
TECHNIQUES

**SELF-INSPECTION AT THE LEVEL OF ROOM OR BUILDING SECTION**  
**11- INSERT THE MEASURED VALUES IN THE SOFTWARE**

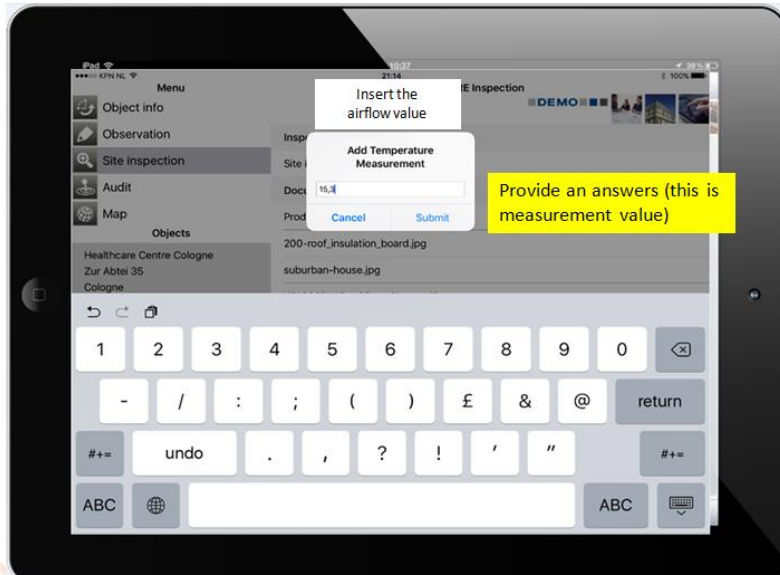

13 February 2017

M18 REVIEW MEETING

16

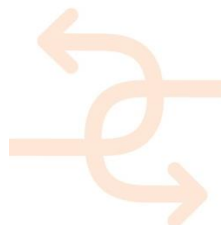

**SELF-INSPECTION AT THE LEVEL OF ROOM OR BUILDING SECTION**  
**12- CHECK IF THE MEASURED VALUES ARE ACCEPTABLE**

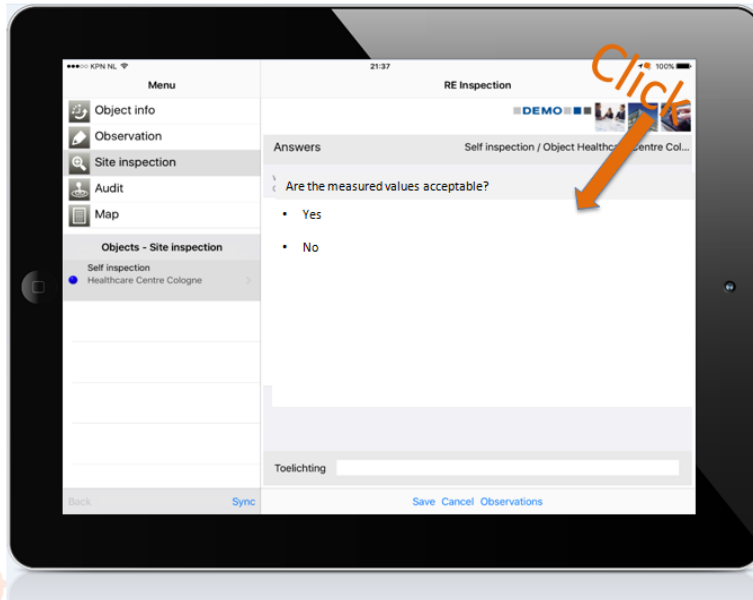

13 February 2017

M18 REVIEW MEETING

17

**SELF-INSPECTION AT THE LEVEL OF ROOM OR BUILDING SECTION**  
**13- APPROVAL AND DECISION-MAKING SUPPORTED BY THE SOFTWARE**



13 February 2017

M18 REVIEW MEETING

18

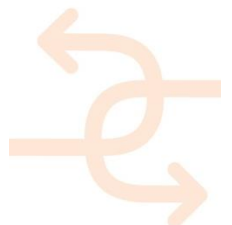

## 12. APPENDIX 4 – Storyboard 4



INSITER INTUITIVE  
SELF-INSPECTION  
TECHNIQUES

### ITEMS

- Overall ICT architecture
- AUGMENTED REALITY showing placement of insulation panels
- BIM based mobile inspection app on iPad
- Applications for planning and cost checking and off-line assembly instruction steps in 3D/4D

13 February 2017

M24 MEETING

2

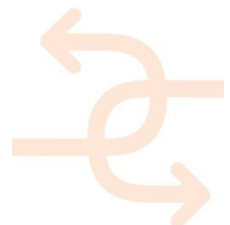

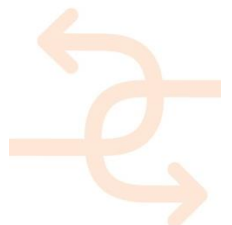
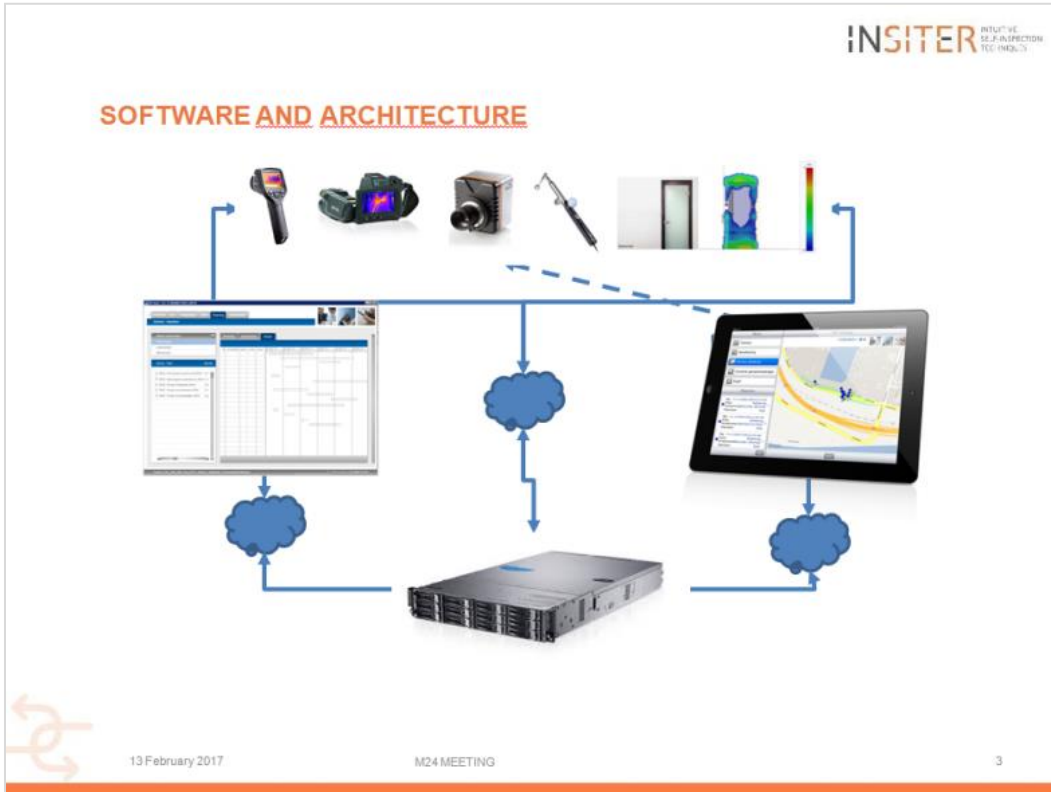

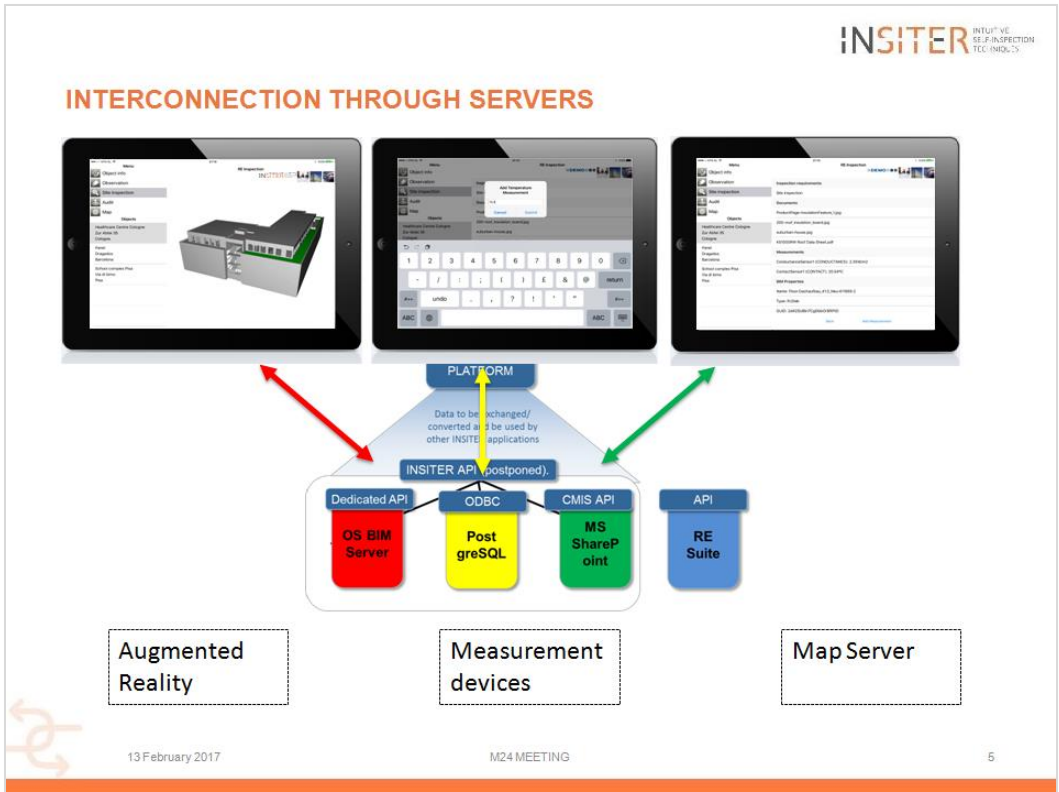

13 February 2017

M24 MEETING

5

## 1. INSITER AUGMENTED REALITY APPLICATION

**AR Application Functionalities**

**Import Data:**

- IFC 3D-models, BIM-based process simulations and animations (FBX, X3D)
- Images (Format: png)
- IFC model parameters, annotations, if applicable

**Executed Tasks and Functionalities:**

Data visualization on defined and selected, feature rich on-site scenes:

- IFC 3D Data Visualization that is associated with the actual camera image, visualized in superimposition (3D model overlay)
- Process sequences, 3D animations for self-instruction (assembly, construction or maintenance)
- BIM-referenced information, instrumentation device data (like thermal images) and other planning data linked to IFC 3D Model in external viewer applications (e.g. PDF documents)

**Export Data:**

None

Figure: Developed INSITER AR Demo Applications

**AR Application Data Formats**

**Data Formats:**

BIM 3D models or other solid 3D models (IFC,X3D), BIM-based process simulations and animations (FBX, X3D), (thermal, acoustic,...) images (png), acoustic vectors as 3d or image (X3D), IFC model parameters or external planning data (TBD). Camera image of feature or contour rich environment and/or AR markers for AR tracking.

[Related tools: Instrumentation and Measurement devices providing images or 3D data linked to 3D/IFC objects; 3D CAD tools and modelling software, external data/document viewers,...]

13 February 2017

M24 MEETING

© Fraunhofer 6

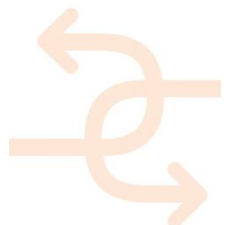

## 1. INSITER AUGMENTED REALITY APPLICATION

**Construction or refurbishment processes** concerning UNIVPM cooling room including the **AR visualization concept of instrumentation devices data** within an AR pilot case application

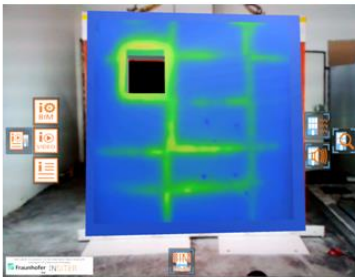

13 February 2017

M24 MEETING

© Fraunhofer 7

## 2. BIM BASED MOBILE INSPECTION

- DEMO - DEMONSTRATION



13 February 2017

M24 MEETING

8

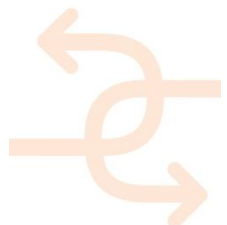

### 3. APPLICATIONS FOR PLANNING AND COST CHECKING AND OFF-LINE ASSEMBLY INSTRUCTION STEPS IN 3D/4D

- Processes / self-instruction in a web-based solution
- Microsoft HoloLens – embedded [ifc](#) viewer
- 3D models online



13 February 2017

M24 MEETING

9

### 3. PROCESSES / SELF-INSTRUCTION IN A WEB-BASED SOLUTION

- *HTML5 / WebGL Solution*
- *Running on PC's / Laptops as well as Mobile Devices*
- *Can be cached to run all processes in off-line mode*
- *Processes shown step-by-step (both directions possible)*
- *Dynamic objects during different steps*
  - <http://rdf.bg/INSITER/arrows/>
  - <http://rdf.bg/INSITER/labtest/>



13 February 2017

M24 MEETING

10

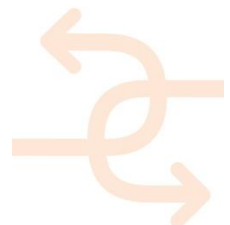

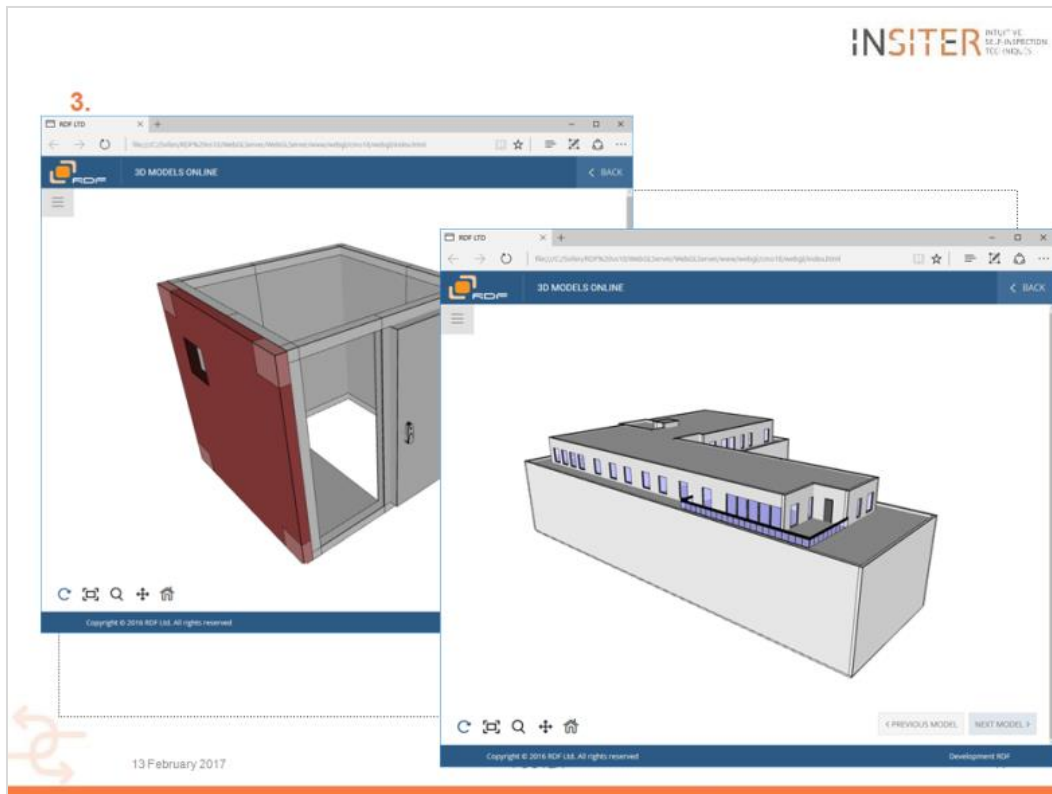

### 3. MICROSOFT HOLOLENS – EMBEDDED IFC VIEWER

- *Low- End solution [no professional functionality]*
- *Augmented Reality on future devices*
- *No AR specific software required*
- *Running Embedded on the device (no internet required)*
- *Source code available for commercially interested parties*
  - [http://rdf.bg/downloads/20161016\\_203154\\_HoloLens.mp4](http://rdf.bg/downloads/20161016_203154_HoloLens.mp4)

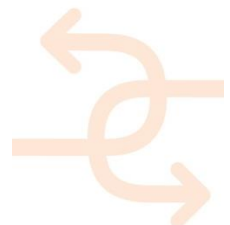



3.



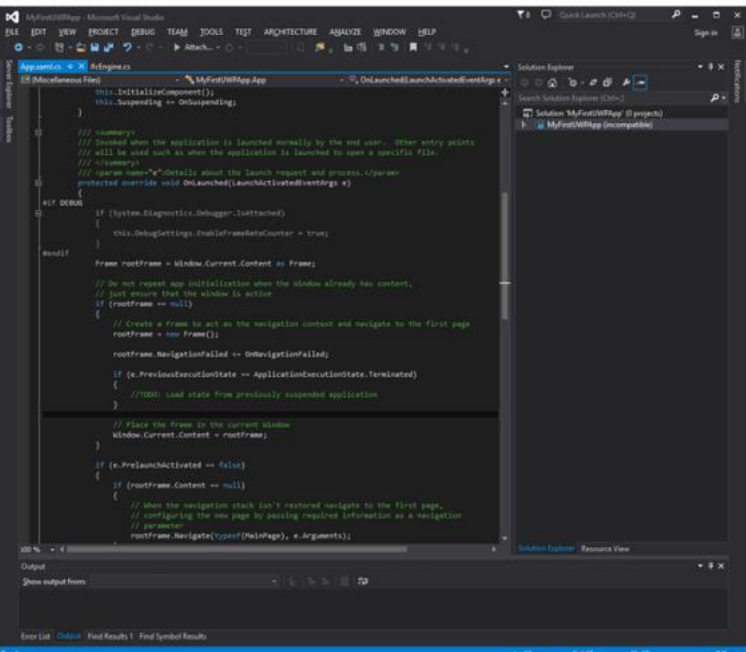

13 February 2017

M24 MEETING

13

# COLOPHON



13 February 2017

M24 MEETING

DMO, FRH, RDF

1.0



THIS RESEARCH PROJECT HAS RECEIVED FUNDING FROM THE EUROPEAN UNION'S H2020 FRAMEWORK PROGRAMME FOR RESEARCH AND INNOVATION UNDER GRANT AGREEMENT NO 636063.

THE INFORMATION IN THIS PUBLICATION DOES NOT NECESSARILY REPRESENT THE VIEW OF THE EUROPEAN COMMISSION.

© INSITER  
ALL RIGHTS RESERVED. ANY DUPLICATION OR USE OF OBJECTS SUCH AS DIAGRAMS IN OTHER ELECTRONIC OR PRINTED PUBLICATIONS IS NOT PERMITTED WITHOUT THE AUTHOR'S AGREEMENT.





## 13. APPENDIX 5 – technical info about CARTIF-3

The complete technical info about CARTIF-3 Building is uploaded to the share point within the WP5 folder:

<http://www.insiter-project.org/Shared%20Documents/Forms/AllItems.aspx?RootFolder=%2fShared%20Documents%2f11%20WP5%2fCARTIF%20demo%20building%20case&FolderCTID=0x012000C2A304B4D90D9040A6CB656C2EE845CA&View=%7b6E9E3FDF%2d936F%2d48F4%2d9D22%2dA1971DF3C0F1%7d>

It consists of a ZIP file containing:

- The complete execution project of the building (in PDF), providing all layouts from page 386 onwards.
- The project execution layouts (in DWG) for the basement level, ground floor, first floor and second floor.
- 3D DWG models (raised in the basic project design, and subsequently modified) and 3D MAX models (corresponding to the final design of the project's implementation).

The Cartif-3 building is offering a wide range of testing and validation options related to point cloud laser measurement analysis and HVAC and M&E analysis for maintenance issues. The potential of the CARTIF-3 building as one of INSITER's six demonstrators is summarized as this:

Graphical documentation (available and to be developed):

Figure 70

Range of HVAC/MEP systems:

- Monitoring systems currently working (temperature, humidity, light intensity and occupancy): see Figure 71 and Figure 72
- Complete TRNSYS simulation: see Figure 73
- Continuous assessment of pathologies: see Figure 74
- Proper definition and monitoring of energy KPI: see Figure 75 and Figure 76
- Proper definition and monitoring of comfort KPI: see Figure 77

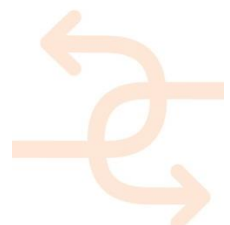

**CARTIF DEMONSTRATOR – 2D & 3D DRAWINGS**



**BIM:**

The thermal envelope and HVAC systems: To be modelled.

What about “static” sensors?: IFC2x3 (Revit) vs IFC4 (INSITER).

Figure 70: 2D and 3D considerations (CAD and BIM)

**CARTIF DEMONSTRATOR – HVAC/MEP SYSTEMS**

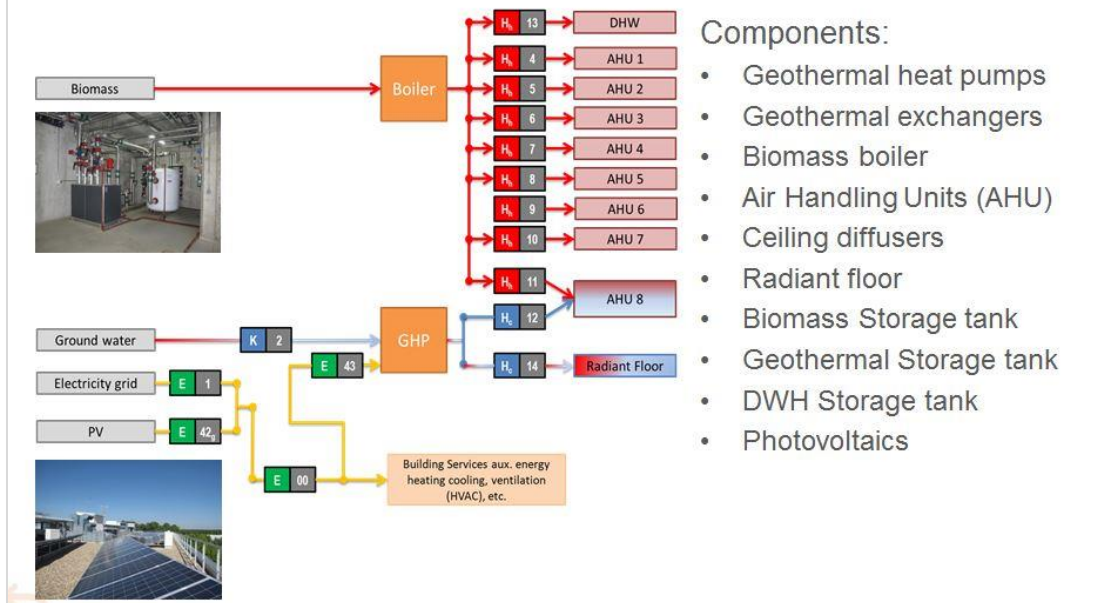
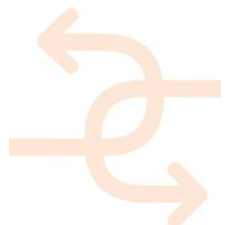

Figure 71: CARTIF-3's HVAC/MEP systems



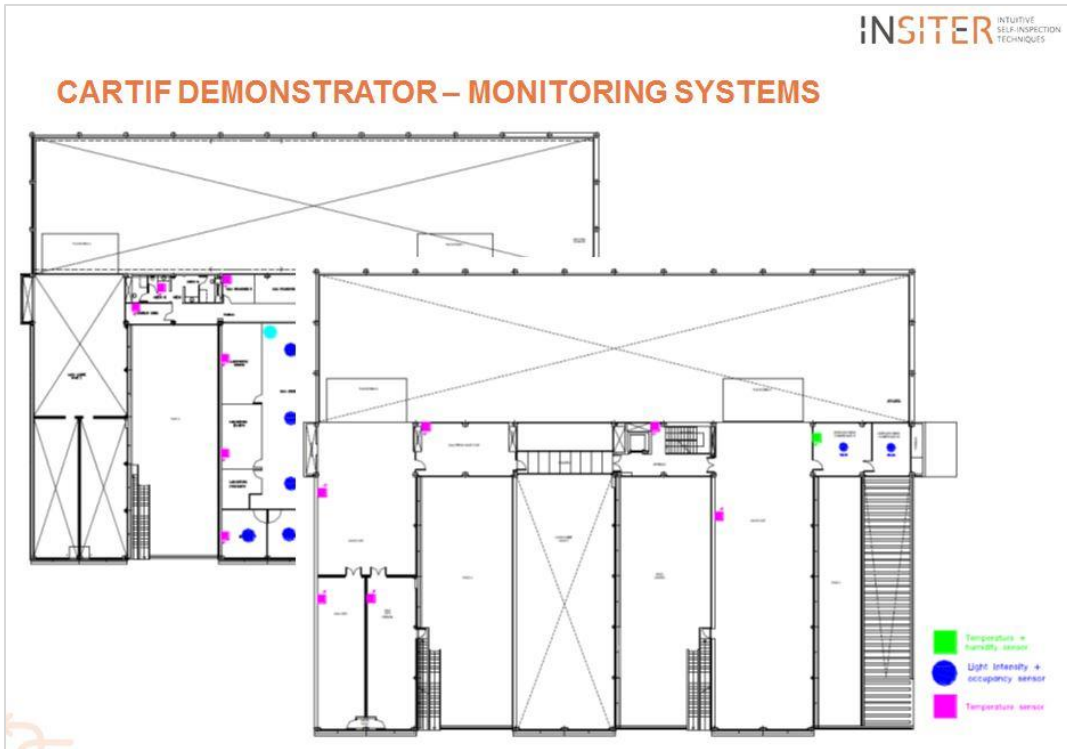

Figure 72: CARTIF-3's monitoring systems

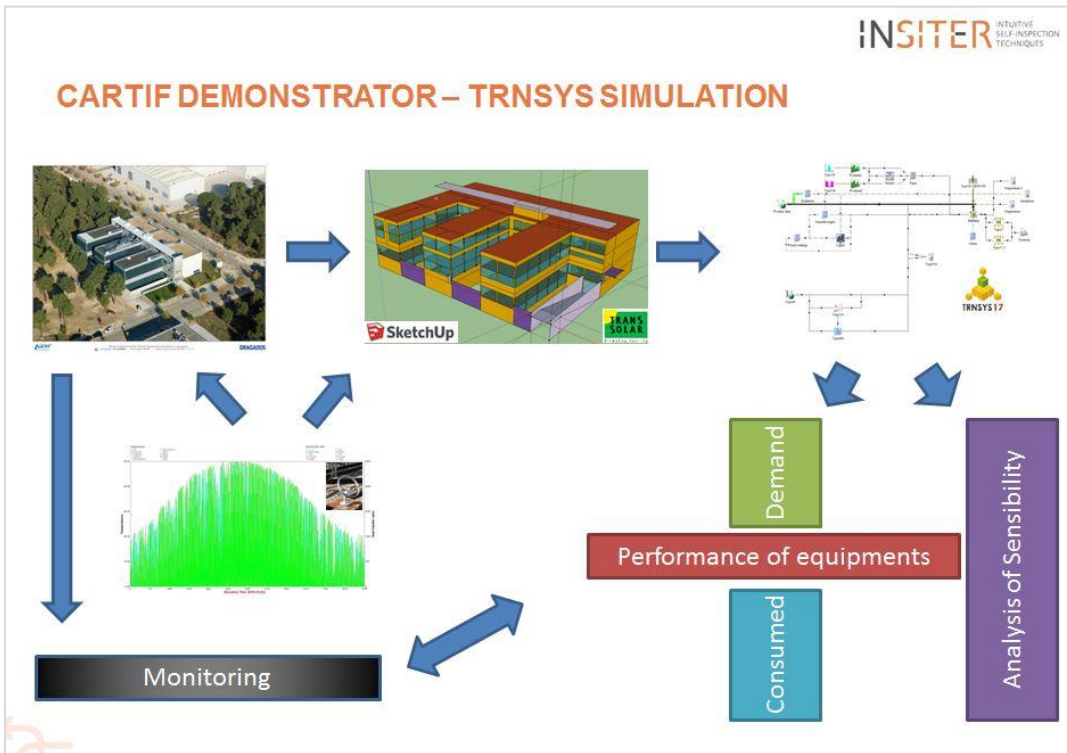
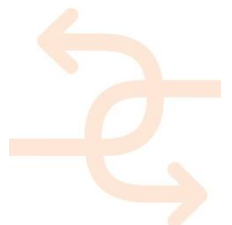

Figure 73a: CARTIF-3's TRNSYS simulation



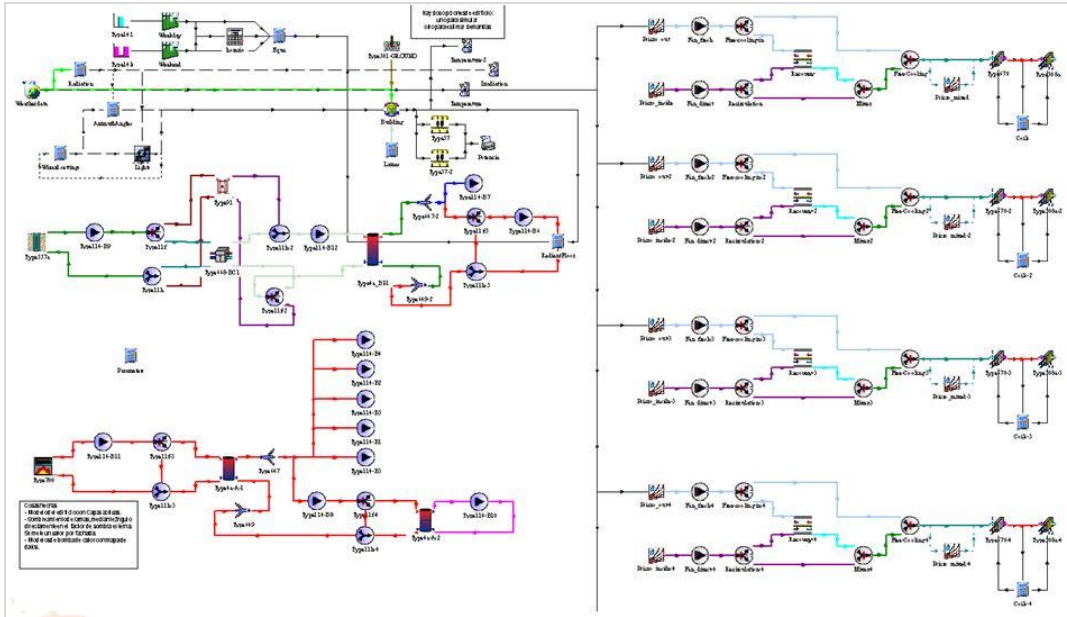
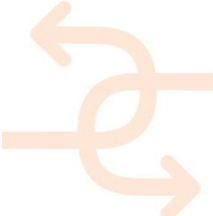

Figure 73b: CARTIF-3's TRNSYS simulation

### CARTIF DEMONSTRATOR – BUILDING PATHOLOGIES

Pathology	Location	Solution
Thermal bridges	Windows and doors	Not apply
Lack of insulation	Industrial façade	Increase of the insulation panels in the north façade.
Bad plumbing	Distribution circuit	Modification of the pipes and sensors
Low comfort level	Offices	Integration of control systems and monitoring
Low temperatures	Industrial space	Not apply
Panels connectivity	Thermal envelope	Not apply
Bad installation (flow)	Distribution circuit	Re-size distribution systems to ensure comfort
Overheating in summer	Cooling system	Application of free-cooling to reduce temperatures

Figure 74: CARTIF-3's pathologies registering



### CARTIF DEMONSTRATOR – ENERGY KPI

Equipment	KPI	Description
Geothermal heat pump	COP	Coefficient of operation of heat pump on winter.
	Ed_GHP	Delivered thermal energy from geothermal heat pump
	Ed_GEO	Delivered electrical energy to the geothermal system
	EER	Energy efficiency ratio
Air Handling Units (AHU)	Ed_AHU	Delivered electrical energy from electricity grid for AHUs systems
	h	Thermal efficiency of the heat recovery
Biomass boiler	Ed_BIO	Delivered thermal heating energy from biomass boiler
	h	Efficiency of boiler
	Ed_BB [B2]	Delivered electrical energy to the biomass system

KPI	Description	Units
CIII_XX_BB	Value of the electrical energy consumed by the biomass boiler	kWh
CIII_XX_BIO	Value of the thermal energy consumed by the Biomass boiler	kWh
CIII_XX_GEO	Value of the electrical energy consumed by the geothermal heat pump	kWh
CIII_XX_AHU	Electrical energy used by the AHUs	kWh
CIII_XX_LGT	Electricity used to illuminate occupied spaces in the building	kWh
Pe_TOT	Total primary energy of the building	kWh/m <sup>2</sup> y
CIII_Pe_PV	Total produced electricity	
Ed_TOT [T1]	Delivered thermal heating energy total	kWh
Ed_TOE [T2]	Delivered electrical energy from electricity grid	
Ed_PV [P1]	Delivered energy by PV Plant	
CO2_GHP	CO2 emissions from geothermal heat pump concerning electrical energy	
CO2_BIO	CO2 emissions from biomass boiler concerning thermal energy	

Figure 75: CARTIF-3's energy KPI definition and monitoring – see D1.4 and D1.6 for KPI definition

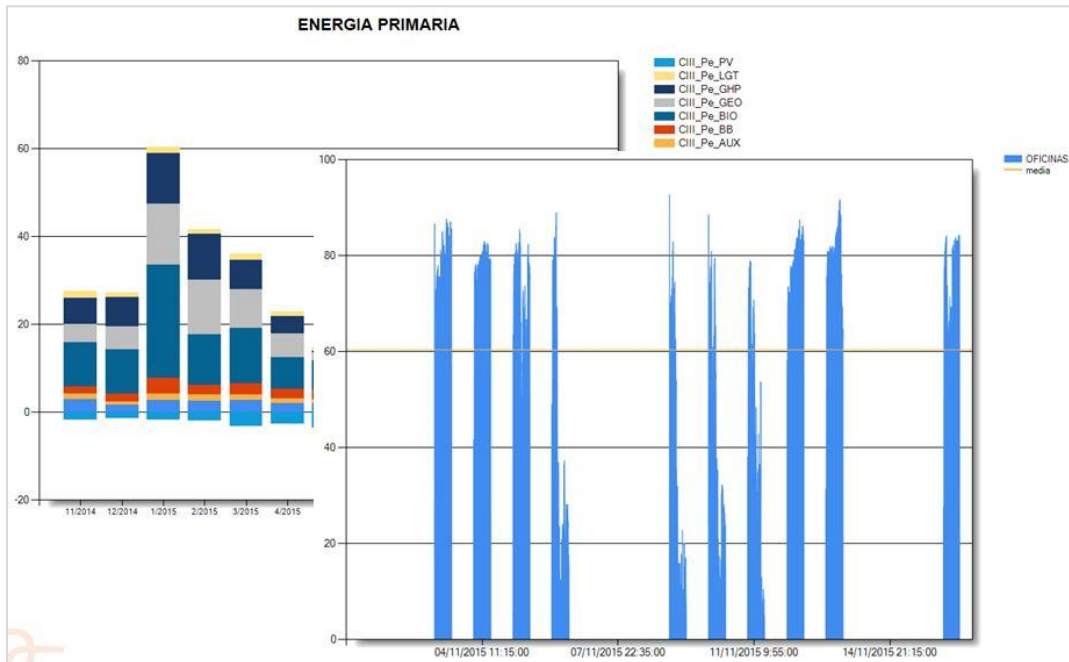
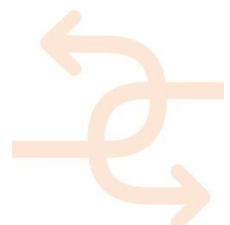

Figure 76: CARTIF-3's energy KPI definition and monitoring



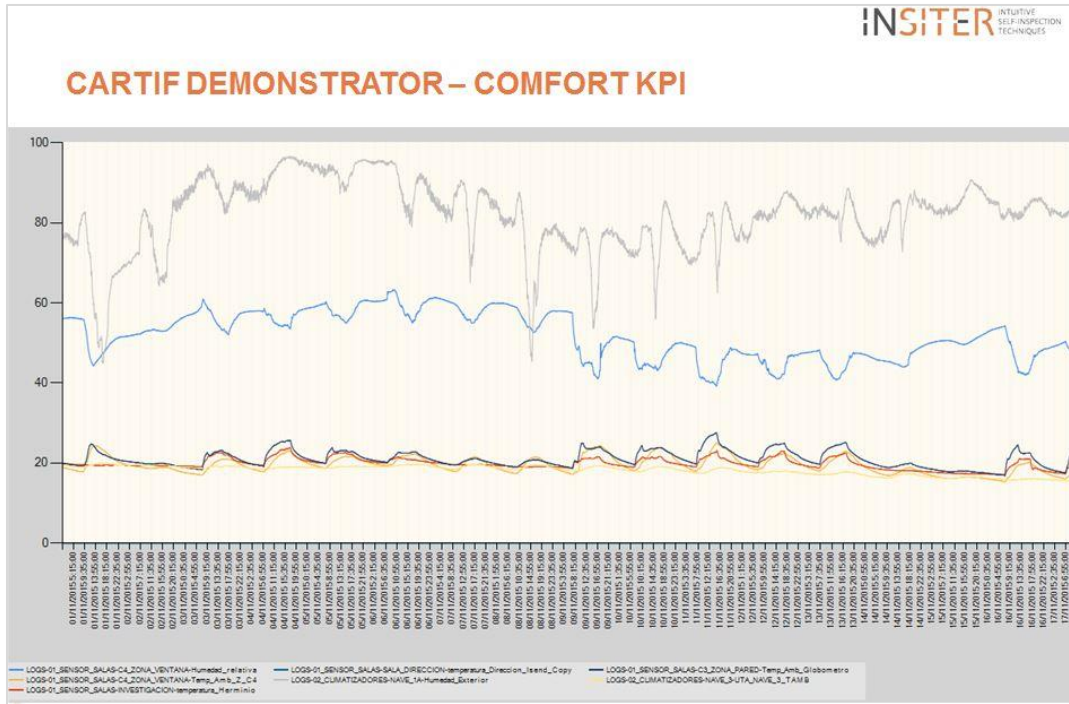

Figure 77: CARTIF-3's comfort KPI registering

